



# Graphite™

## User Guide





# Graphite™

## User Guide

---

# GRAPHITE™

December 2013

In December 2008 selected assets of Ashlar Incorporated were transferred to Vellum Investment Partners, LLC pursuant to the 2005 agreements between the companies. Eventually, all assets and selected liabilities of Ashlar Incorporated will be transferred to Vellum Investment Partners. As part of this process, specific copyrights and trademarks will be transferred and re-registered as appropriate in various countries worldwide.

Therefore, for the purposes of this copyright and trademark notice, Ashlar Incorporated and Vellum Investment Partners LLC shall be collectively, jointly, individually, and separately known as Ashlar-Vellum. All references to Ashlar-Vellum that follow shall apply as appropriate at the time of receipt or reading, in the country of the publisher, distributor, recipient or reader to one or both of Ashlar Incorporated and Vellum Investment Partners LLC.

The word Ashlar is a registered trademark in the United States of Ashlar-Vellum. The word Ashlar and logo Ashlar with Bricks are registered trademarks in the United States and Benelux of Ashlar-Vellum. The word Vellum is a registered trademark in the United States, Japan, Benelux and France of Ashlar-Vellum. Where not registered, Ashlar (word), Ashlar with Bricks (word & logo), Vellum (word) and Ashlar-Vellum (words) are trademarks of Ashlar-Vellum. Graphite (word), Graphite C-Hex (logo), Cobalt (word), Cobalt C-spiral (logo), Xenon (word), Xenon X-graphic (logo), Argon (word), Argon A-loop (logo), Chromium (word), Chromium Cr-graphic (logo), Iridium (word), Iridium Ir-graphic (logo), Ashlar-Vellum (words), Ashlar Bricks alone (logo), Creative Intuition Powered by Vellum (words), The Ultimate Product Design and Development Tool (words) and Software that works the way you think (words), Ashlar-Vellum Software that works the way you think with Bricks (words & logo), Ashlar-Vellum Software that works the way you think with Bricks and Swoosh (words & logo), Vellum:environments (words & logo), Vellum:tracks (words & logo), Vellum:decals (words & logo), Vellum:materials (words & logo), Graphite Tips & Tricks (words & logo) are all trademarks of Ashlar-Vellum.

Other marks (if any) are property of their respective owners.

All rights reserved. No part of this document may be reproduced, photocopied or transmitted in any form without the expressed permission of Ashlar-Vellum. The software described in this document is provided under a license and may be used or copied only in accordance with the terms of such license.

Limit of Liability/Disclaimer of Warranty: The information provided in the document is distributed, as is, without warranty. While every precaution has been taken in the preparation of this document, Ashlar-Vellum, Ashlar-Vellum employees, contractors, sub-contractors, and suppliers shall have no liability to any person or entity with respect to liability, loss or damage caused directly or indirectly by the instructions contained in this document or by the software described herein.

Copyright © 2004-2013 Ashlar-Vellum. All rights reserved.

C6USE1312

Ashlar-Vellum

+1 800 877 2745

[www.ashlar-vellum.com](http://www.ashlar-vellum.com)

---



---

# Table of Contents

<b>Table of Contents</b> .....	<b>i-1</b>
<b>User Guide Documentation</b> .....	<b>1-1</b>
Chapter Layout .....	1-1
User Guide Chapter Breakdown .....	1-3
<b>Graphite Overview</b> .....	<b>2-1</b>
Wireframe Drafting .....	2-1
The Models .....	2-2
The Drafting Assistant .....	2-5
The Design Process .....	2-6
<b>The Basics</b> .....	<b>3-1</b>
Using a Mouse .....	3-1
Parts of the Graphite Window .....	3-3
Menu Bar .....	3-12
Preferences .....	3-19
<b>The Drafting Assistant</b> .....	<b>4-1</b>
Snapping to Geometry .....	4-2
Drafting Assistant Construction Lines .....	4-9
Permanent Construction Lines .....	4-11
<b>Basic Environment Settings</b> .....	<b>5-1</b>
Pen Styles .....	5-1
Pen Characteristics .....	5-3
Setting Units .....	5-21
The Grid .....	5-23
Drawing at Full Scale .....	5-25
The Drafting Process .....	5-26
OS Settings .....	5-29
Saving Preferences .....	5-30
Save Palettes .....	5-33
<b>Advanced Environment Settings</b> .....	<b>6-1</b>
Add Command .....	6-2
Macros .....	6-3
File Organization .....	6-8
3D Viewing .....	6-8
<b>Drawing Tools</b> .....	<b>7-1</b>
Drawing Techniques .....	7-3
The Status Line .....	7-6
The Message Line .....	7-9
Drawing Tools - Description and Use .....	7-10

<b>3D Drawing Tools</b> .....	<b>8-1</b>
Geometry in 3D .....	8-1
3D Features and Tools .....	8-4
Work Plane .....	8-9
<b>Selecting Objects</b> .....	<b>9-1</b>
Objects .....	9-2
Indicating Selection .....	9-3
Selection Process .....	9-4
<b>Editing Objects</b> .....	<b>10-1</b>
Editing Tools .....	10-2
Moving Objects .....	10-24
Copying Objects .....	10-27
Sizing Objects with Tools .....	10-29
Editing Commands .....	10-32
Erasing Geometry .....	10-34
Changing the Characteristics of Objects .....	10-35
Arranging Geometry .....	10-37
<b>Adding Details</b> .....	<b>11-1</b>
Text .....	11-1
Crosshatching and Solid Fills .....	11-12
Arrowheads .....	11-19
<b>Dimensions</b> .....	<b>12-1</b>
Associative Dimensions .....	12-2
Dimensioning Overview .....	12-3
The Dimension Tools .....	12-9
Dimension Appearance .....	12-31
Parametric Dimensions .....	12-47
<b>Viewing Geometry</b> .....	<b>13-1</b>
Zooming and Panning .....	13-2
Layers .....	13-7
View Displays .....	13-17
Views Menu .....	13-25
<b>Advanced Viewing Techniques</b> .....	<b>14-1</b>
Sheets .....	14-1
Models .....	14-5
Views .....	14-15
Combining Sheets, Views and Models .....	14-36
<b>Graphite Documents</b> .....	<b>15-1</b>
Using Documents .....	15-2
Importing and Exporting .....	15-9
Drawing at Full Scale .....	15-26

---

Drawing Scale and Paper Size .....	15-28
Drawing Formats .....	15-35
Forms .....	15-39
Printing or Plotting a Drawing .....	15-41
<b>Parametrics .....</b>	<b>16-1</b>
Introduction to Parametrics .....	16-2
Using Parametrics .....	16-2
Parametric Drafting .....	16-9
Parametric Problems .....	16-13
Complex Parametric Drafting .....	16-20
Parametrics and Grouped Objects .....	16-27
<b>Symbols.....</b>	<b>17-1</b>
Using Symbols .....	17-2
Placing Symbols .....	17-3
Smart Symbols .....	17-6
<b>2D Analysis .....</b>	<b>18-1</b>
2D Analysis Command .....	18-2
Calculations .....	18-5
<b>Bill of Materials.....</b>	<b>19-1</b>
Introduction .....	19-2
Attributes and Objects .....	19-3
Assigning Attributes .....	19-7
Editing Attributes .....	19-11
Item Numbers .....	19-12
Bill of Materials .....	19-15
<b>GD&amp;T .....</b>	<b>20-1</b>
Background .....	20-2
Alignment Information .....	20-2
Bonus Tolerance .....	20-3
Basic Dimension .....	20-4
GD&T Feature Control Frame .....	20-5
Geometric Characteristics .....	20-5
The GD&T Label .....	20-13
<b>Appendix A: Operators and Units.....</b>	<b>A-1</b>
<b>Appendix B: Special Characters.....</b>	<b>B-1</b>
Windows .....	B-1
Macintosh .....	B-2
Adding Special Symbols to the Dimensions Text .....	B-2
<b>Appendix C: Program Settings &amp; Files.....</b>	<b>C-1</b>
<b>Glossary .....</b>	<b>G-1</b>
<b>Index.....</b>	<b>I-1</b>

---



---

# User Guide Documentation

This *User Guide* is written for both Windows and Mac OS X platforms of Graphite. Before using this manual it is necessary to install Graphite using the instructions contained in the *Getting Started* Guide that came with the software. After installation continue with the tutorial exercises included in that book to familiarize yourself with the tools, features and commands of Graphite, and to maximize your productivity in the shortest amount of time.

## ***Chapter Layout***

The chapters are arranged in the order of the design process starting with the basics. It then provides explanations of each tool, editing procedures, adding details and printing. Each chapter contains subheadings indicating the different sections and within those are further subdivisions as needed.

## **Windows and Macintosh Notations**

Throughout the manual, notations are included to perform tasks using either platform. Steps are identical except for specific keyboard commands. In cases where the steps vary, each are listed.

## **Menus and Submenus**

### ***Choosing Commands***

In the example exercises, you are directed to choose commands contained in submenus of other menus. For example, if asked to select *Define* in the Color submenu of the Pen menu, it appears as ***Pen>Color>Define***.

### *Tip:*

Tips, referrals to other chapters, and alternative ways to accomplish a task are displayed in the margin throughout the manual.

## Margin Notes

Graphite includes margin notes that provide information that may help you use the software. There are three types of margin notes: Tips, Tech Notes and Referrals. These notes have been given a special treatment so that you can instantly recognize their significance and locate them for future reference.

### ***Tip***

A tip provides instructions for getting the most out of Graphite. Tips may show you how to speed up an operation or how to perform some timesaving drawing technique.

### ***Tech Note***

A technical note provides additional technical information, not necessary for using Graphite but useful in understanding how it works.

### ***Referral***

A referral directs you to related information contained somewhere else in the manual for the particular topic being addressed.

## Style Conventions

This manual uses various style conventions which highlight certain terms or phrases. The list below includes an explanation and an example in parentheses. The conventions are as follows:

<b>Bold</b>	Tool palette names ( <b>Light</b> palette); Tool name ( <b>Single Line</b> tool); Keyboard-entered text; Definition terms (as shown in these style conventions).
<i>Italic</i>	Terms used for the first time in a chapter; ( <i>Parametrics</i> ); Drafting Assistant notations ( <i>midpoint</i> ); tool and dialog box options ( <i>Angle</i> data field); book references ( <i>User Guide</i> ); Message Line directions ( <i>Single Line:Pick the beginning point.</i> ); margin note headings ( <i>Tip</i> ); menu commands ( <i>Extrude</i> ); filenames ( <i>Graphite.ini</i> ); stand alone extensions ( <i>.dwg</i> ); directory names; drawing names.
<b>Bold and Italic</b>	Command series ( <b>Pen&gt;ColorDefine</b> ).
ALL CAPITALS	Key names on the keyboard (ENTER, RETURN).

Title Capitalization	Dialog box names (Edit Objects); menu names (Pen menu); special Graphite phrases (the Drafting Assistant).
all lower case	File names (graphite.ini); stand-alone file extensions (.dwg).

## ***User Guide Chapter Breakdown***

The chapters are grouped into sections dealing with a specific area.

### **Sections**

- |                                   |  |
|-----------------------------------|--|
| <b>1. Overview</b>                | Contains chapters that provide information on the documentation layout, basic elements of Graphite and the Drafting Assistant. |
| <b>2. Setting the Environment</b> | Contains information on setting the drawing environment.   |
| <b>3. Creating Geometry</b>       | Contains information on creating geometry using the tools of Graphite.   |
| <b>4. Editing</b>                 | Contains information on using the tools and commands to edit your geometry.  |
| <b>5. Document Detailing</b>      | Contains information on adding text and dimensions to your drawing.  |
| <b>6. Viewing Your Designs</b>    | Contains information on viewing your geometry.   |
| <b>7. Documents</b>               | Contains information on opening, saving, importing and exporting files.  |
| <b>8. Parametrics and Symbols</b> | Contains information on using parametrics and placing symbols.   |
| <b>9. Geometric Analysis</b>      | Contains information on performing a 2D analysis on your geometry.   |

### *Referral:*

Specific page information on a particular tool or command can be found in the index.

## Appendices

### Operators and Units

Describes all operators and units which are accepted by all Graphite data fields.

### Special Characters

Lists all special characters not directly available from the keyboard and symbols that are used in Graphite.

### Program Settings & Files

Contains all of the default settings for Graphite following installation. It also includes a list of all the folders and files that come with the program.

## Other

### Glossary

Defines terminology used in Computer Aided Design and Drafting (CADD) and Graphite.

### Index

Lists features, tools and actions in Graphite and their associated page number location in the manual.

## Graphics

Most of the graphics in the manuals apply to both platforms of Graphite. In those instances that require a platform and software reference, a Graphite Windows graphic is used. When necessary, both Windows and Macintosh graphics are included.



## New Update Installer

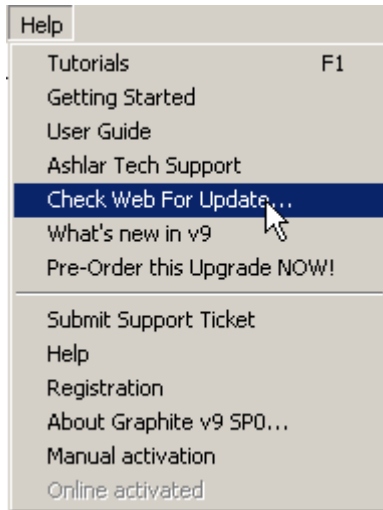

In the Graphite Help menu is an item called Check Web For Update. Click it and Graphite links to the Ashlar-Vellum website to see if a new build of the software is available as a free update. This update will be a small file, not the entire program, which can be downloaded without disturbing your Preference file or your registration codes.



# Graphite Overview

As mentioned in the *Getting Started* section of this manual, Graphite is a powerful program that is quick to learn and use due to its technology. Graphite helps you get the job done within your timeframe.

This chapter provides a brief overview of the following concepts:

- chapter 2 Wireframe Drafting
- chapter 2 The Models
- chapter 2 The Drafting Assistant
- chapter 2 The Design Process (including Drawing at Full Scale and Drawing Formats)

## ***Wireframe Drafting***

In Graphite you create wireframe models. A wireframe model consists of the geometry that makes up the edges of the object.

A wireframe model is often used in place of a prototype so that simulations and tests are accomplished on the computer rather than in the laboratory. Models are used for checking the visual specification, measuring distances between points within the model and observing the visual and real intersections of lines.

3D wireframe models are most useful for showing multiple views and doing 2D dimensioning and drafting on those views. This lets you design in 3D, and then produce 2D working drawings from that 3D model.

*Referral:*

The definition of models is also discussed in Chapter 14.

## The Models

Models exist in 3D space in the computer's memory, whether the geometry is two or three dimensional. A model is any combination of geometry, such as lines, arcs, circles, dimensions, text, etc. Models are created in an infinitely large three-dimensional area. (In the following graphics each model has its own imaginary 3D model space). Models are not created directly on the sheet. What you see on the sheet is only a projected view of the model.

A sheet in Graphite is an infinite 2D planar area (always aligned parallel to the screen) that displays an image of one or more models. View the model as if looking through a camera while it moves around the model. The image of a model is picked up by either a *sheet camera* or a *detail view camera*. The sheet camera projects the image directly onto the sheet (called a *Sheet View*). The detail view camera projects the image into a *view window* (called a *Detail View*) which rests on the sheet. Sheets do not actually contain any geometry, only images of geometry.

Your computer screen displays all the views on the current sheet. In the graphic on the right a Top view of the model is picked up by the sheet camera and projected onto the current sheet. In the Top view the sheet camera is aligned parallel to the sheet.

Opening a document, you are looking down on top of the x, y plane and you cannot see anything in the z-direction, which is coming toward you, away from the screen.

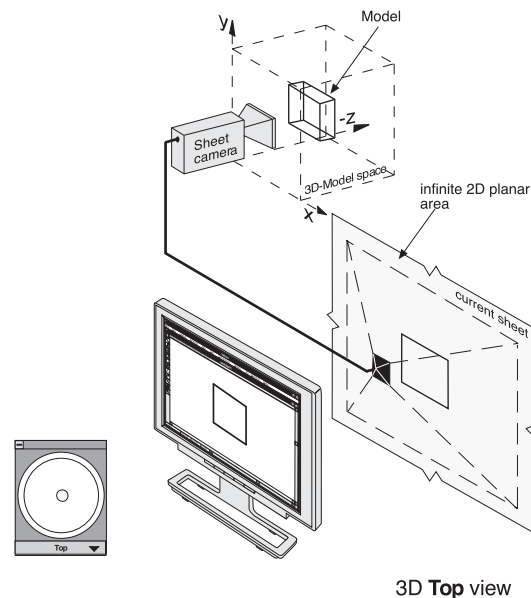

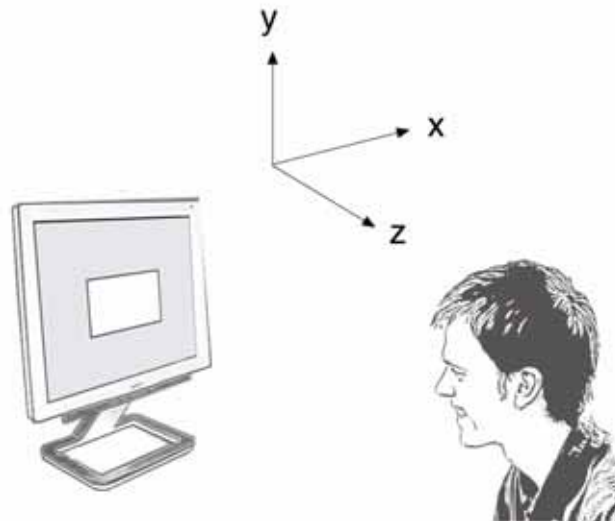

### ***Graphite 3D Models***

Rotate the image to see what you are drawing in the z-direction.

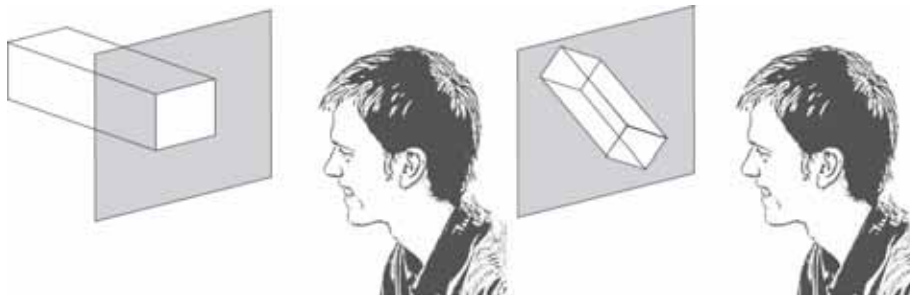

The on-screen *Trackball* rotates the sheet camera around the 3D model. This changes your orientation, it does not rotate the model. The three-dimensional object geometry (the model) stays fixed, even if the opposite impression is displayed on the screen.

In the following graphic the sheet camera is rotated to the Trimetric view.

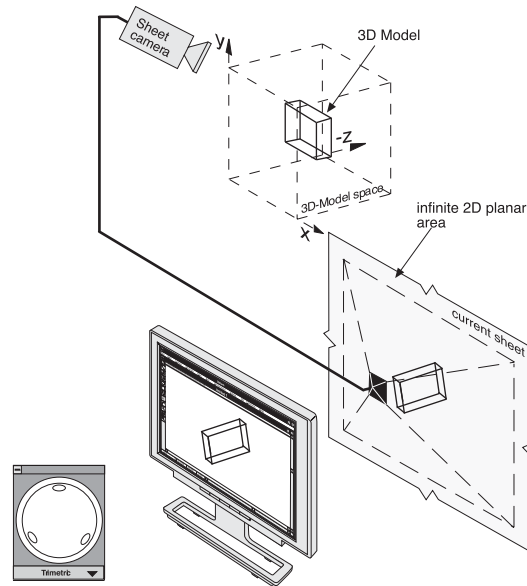

The Sheet camera is rotated to the **Trimetric** view

When rotating the image with the on-screen Trackball, it is as though the movement of the pointer on the Trackball corresponds to a fulcrum; the location where you press the mouse button becomes the fulcrum and the movement of the mouse rotates the model around that fulcrum point. What you see on the screen responds to the view of the sheet camera.

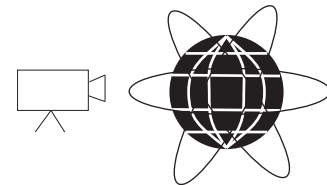

### **Graphite 3D**

When creating view windows, either detail views, drafting layouts, or design layouts, each view window looks at the same model. When a change is made in any view window, the model changes; therefore, the model in every view changes.

For more information on models, see chapter 14 Advanced Viewing Techniques.

## The Drafting Assistant

The *Drafting Assistant* is unique to Ashlar-Vellum software and makes Graphite easy to use because it thinks like a designer. The *Drafting Assistant* guides a designer in the creation of geometry. It displays temporary construction lines, provides information about existing geometry, and gives notations of the relationship between new and existing geometry in all three dimensions.

Move the pointer near an existing geometric construction and the *Drafting Assistant's snap point* locks onto individual geometry, displaying an *on* notation. The *Drafting Assistant* also displays information about geometric landmarks, such as *endpoints* and *centers*, and temporary automatic construction lines, such as *alignment* and *tangents*.

The following examples illustrate the *alignment* notations for the x, y and z axes.

**align:z**

The z-direction is perpendicular to the work plane.

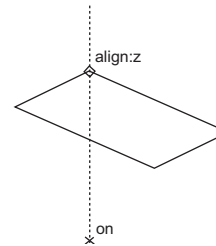

**align:x**

The x-direction is parallel to the work plane.

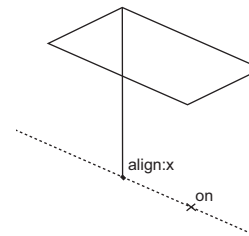

**align:y**

The y-direction is parallel to the work plane.

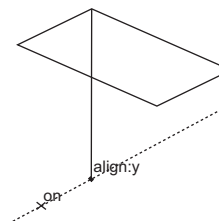

For more information on the *Drafting Assistant*, see chapter 4 The *Drafting Assistant*

## The Design Process

The computer revolutionized the design process. Graphite has contributed to this by allowing you to quickly design a model that previously existed only in your mind's eye.

### Graphite

Using Graphite it is possible to start designing immediately in 3D or begin in 2D and continue later in 3D.

For example, you can choose to begin designing in the Trimetric view orientation so that you see all three directions at once. Display other view windows with the Front, Right, and Top view orientations at quarter scale to observe the construction from other angles. While drawing, you can zoom in and out to enlarge and reduce areas as needed.

Rotate, move the origin, and change the work plane to take advantage of the 3D modeling environment.

### Drawing at Full Scale

In the paper world, a model design begins by deciding what scale to use so that the model fits on a particular size sheet of paper. With Graphite, scaling is postponed until after the model is drawn at full scale. Scale the geometry to fit on a standard drawing format provided by Graphite and then scale the whole drawing to fit the size of paper needed.

### Constructing a 3D Model

There are several different methods to create a model. The following steps are an example of a process for a 3D model:

- Begin the construction by opening a new document.
- Set the preferences you prefer, such as the pen style, grid, and selection modes.

For more information, see chapter 5 Basic Environment Settings

- Display the Triad symbol using the *Show Triad* command. This illustrates the work plane orientation that acts as a point of reference when drawing in 3D.
- Display the Trackball.
- In the view menu of the Trackball, choose Trimetric. The sheet rotates so that the construction is seen from the Trimetric view.
- Create the 3D model using the tool palette and Graphite commands.



- To observe multiple view orientations while modeling, choose *Sheet Into View* from the Views menu, and then specify the *Views Design 4* layout. View windows displaying the Top, Front, and Right view orientations are displayed at quarter scale along the right side of the screen.

For more information on Sheet into Views, see chapter 14 Advanced Viewing Techniques

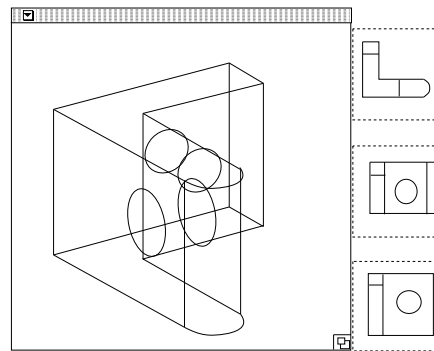

## Drawing Formats

When the model is complete (or to be submitted for review), you might want a drafting version incorporating several views in a drawing format with dimensions and annotations. To create this, import a drawing format and make adjustments to the views as necessary or use a premade layout with format in *Sheet Into View*. This example shows a premade layout with four views.

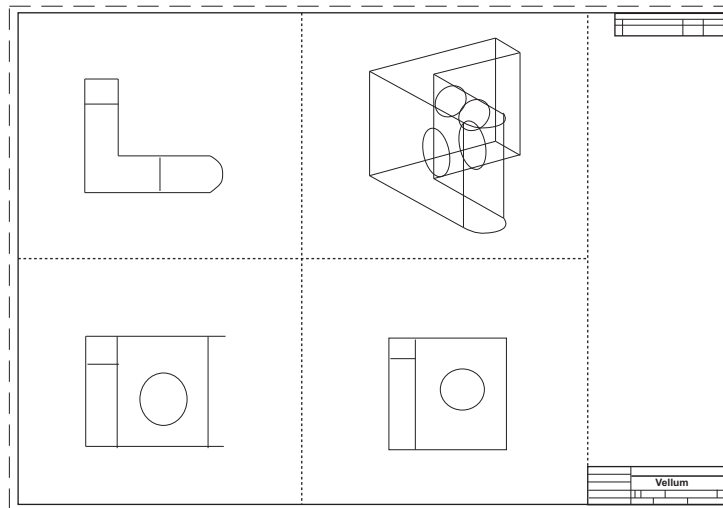

- Flatten any view that contains geometry to be edited independently. For more information on flattening a view, see chapter 14 Advanced Viewing Techniques
- Crosshatch, dimension, annotate, and perform any view editing needed.
- Fine-tune the model if necessary.
- Specify the paper size from the *Print Setup (Windows)* or *Page Setup (Macintosh)* command in the File menu.

- Set the scale for the drawing format to fit on the plotter paper. If an exact scale is not necessary, click Fit in the Drawing Size dialog box and the geometry and format will be scaled appropriately for the paper size specified.
- Plot the finished drawing. For more information on plotting, printing and related activities, see chapter 15 Graphite Documents

# The Basics

This chapter describes the basic components of Graphite. This brief overview of useful features may be all you need to know if you are familiar with CAD software. The following topics are covered:

- Using a Mouse
- Parts of the Graphite Window
- Menu Bar, including the Dialog Boxes
- Preferences

For more information about standard elements such as menus, scroll bars, File menu commands, and dialog boxes, refer to the Windows or Macintosh *User's Guide* that came with your computer.

## *Using a Mouse*

The mouse is your communication device to tell the computer what to do. Use the mouse to indicate locations, choose commands, select tools, and construct objects.

If your mouse has more than one button, use the right button to popup a menu that contains a variety of commands and functions. By default the right mouse button provides shortcuts to the most popularly used commands.

To set up the right mouse button options, right click in the drawing area to activate the menu. Choose **RightMouse**. When the dialog box appears, check the boxes to activate or deactivate items displayed in the popup menu. If your mouse has three buttons or a scroll wheel, click and hold the button or wheel to pan. Move the scroll wheel forward and back to zoom in and out.

### *Tips:*

If you are left-handed and your mouse has more than one button, you can change the functionality to the right mouse button. Make this change in the Control Panel of Windows.

### *Tip:*

If holding down the middle button does not pan, then the button has been defined as something else by the operating system and can be changed in the Control Panel or System Preferences.

This manual uses the following terms for mouse activities:

**Pointer**

An arrow or any other graphic symbol that allows selection or creation of an object. Move the pointer to point to a command or an object on the screen. Depending on its location, the pointer is an arrow or looks like the current tool.



To move the pointer, move the mouse on the mouse pad. Several different mouse actions are used with Graphite.

**Point**

Move the mouse until the pointer is over the desired item.

**Press**

Press and hold down the mouse button.

**Click**

Quickly press and release the mouse button once.

**Double-click**

Click the mouse button twice, quickly in succession.

**Drag**

Press and hold down the mouse button, move the mouse, then release the mouse button.

## Parts of the Graphite Window

Upon starting Graphite, the following window appears.

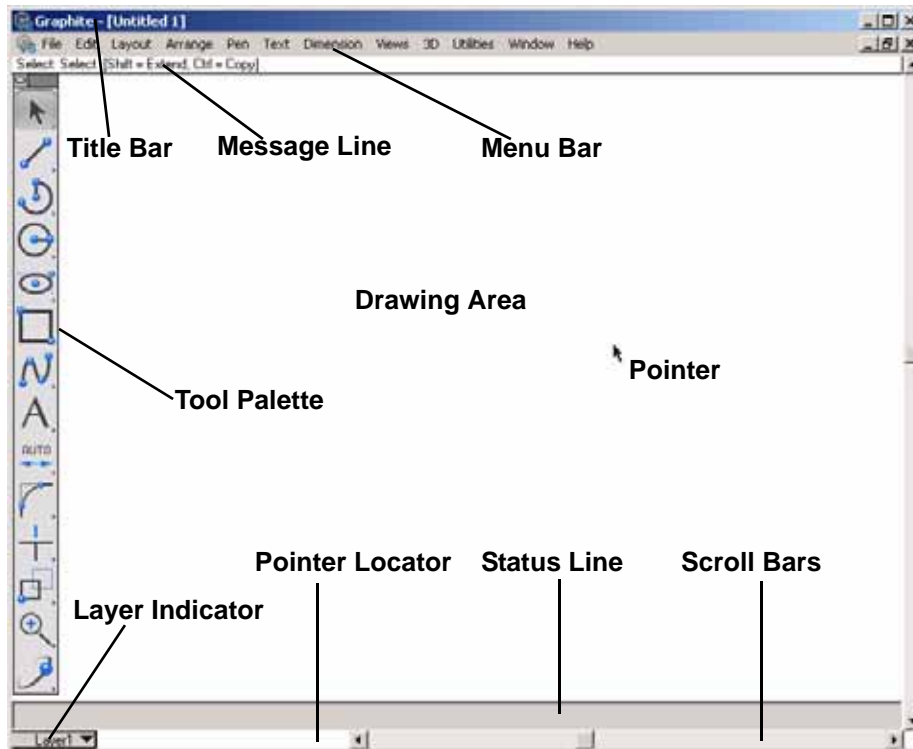

### Title Bar

Includes the title of the active document and buttons for controlling the window including boxes for zooming and closing the program.

### Menu Bar

Contains the Graphite menus of commands and settings. Make choices from the menus using the mouse or special key combinations.

### Tool Palette

Contains the drawing and editing tool icons used for constructing, editing and annotating geometry.

### Pointer

Shows the active position on the screen. If the pointer is in the drawing area, its shape represents the current tool.

<b>Pointer Locator</b>	Shows the x, y coordinates of the pointer location.
<b>Message Line</b>	Displays the name of the current tool and step-by-step instructions for using the tool.
<b>Drawing Area</b>	Consists of multiple layers where geometry is constructed and annotated.
<b>Status Line</b>	Shows the coordinate location and other geometric parameters of the current construction.
<b>Scroll Bars</b>	Move around a drawing so that different sections of it are seen through the Graphite window. The scroll buttons move one line at a time.
<b>Work Layer Indicator</b>	Displays the name of the current layer and provides a menu for changing the work layer.

## Title Bar

The Title Bar includes the name of the current document, and the Control Menu, Minimize and Maximize/Restore buttons (Windows), or the Close and Zoom boxes (Macintosh).

## Windows

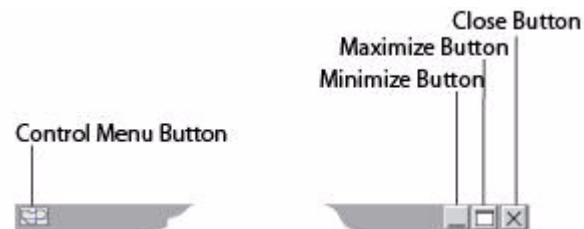

<b>Control Menu Button</b>	<p>Closes, moves, and changes the size of the window. This button is available on all windows and many dialog boxes.</p> <p>Double-clicking this button closes the window without displaying the menu. To choose a different option from the Control menu, click the button once to display the menu and then make the selection.</p>
----------------------------	---

**Minimize Button**

Reduces the Graphite window to an icon near the lower-left corner of the screen. This action does not close or save the document, it only shrinks the window to an icon for performing some other Windows-related task. To redisplay the window, double-click the icon.

**Maximize/Restore**

Displays the window, full or partial screen. Once the window appears full screen, click the button again to restore it to its previous size.

***Macintosh*****Close Button**

Closes the window when clicked. If you attempt to close the window without saving your work, Graphite displays a message with the option to save or not.

**Zoom Button**

Toggles the window size between the previous size and full size.

## Tool Palette

A tool palette is a group of tool icons along the left side of the screen. The icons represent the tools for drawing, editing, and annotating geometry.

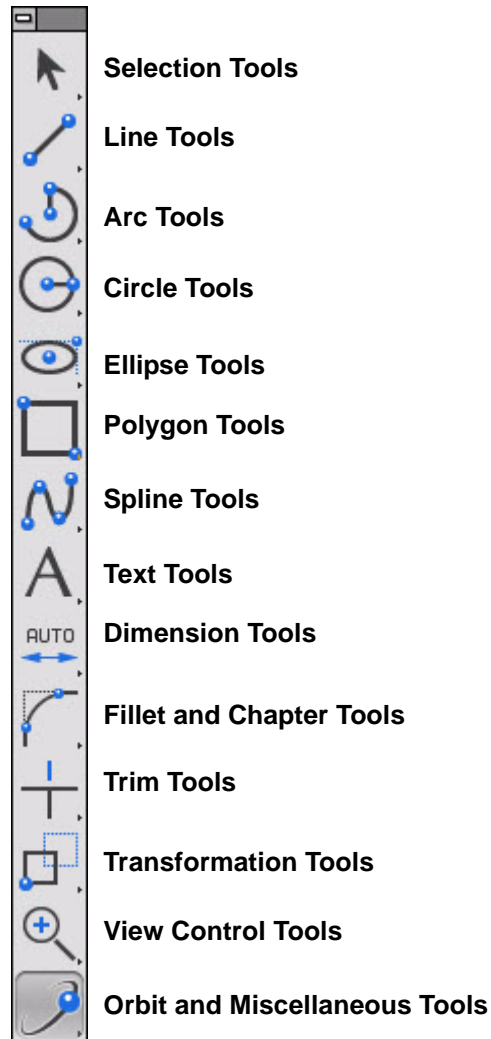



### Selecting a Tool from the Tool Palette

1. Position the arrow pointer on the icon of the desired tool.
2. Click the mouse button.

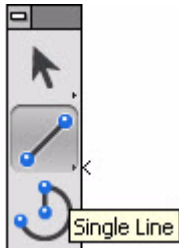

The icon highlights to indicate its selection. The **Single Line** tool is selected here.

### Tool Subpalettes

Most of the tools in the tool palette contain a subpalette with related functions. The arrow in the lower-right corner of the tool icon indicates the presence of a subpalette.

Viewing and selecting from a subpalette are similar to choosing a command from a menu.

### Selecting a Tool from a Subpalette

1. Position the arrow pointer on the tool.
2. Press the mouse button.

The subpalette appears to the right of the tool.

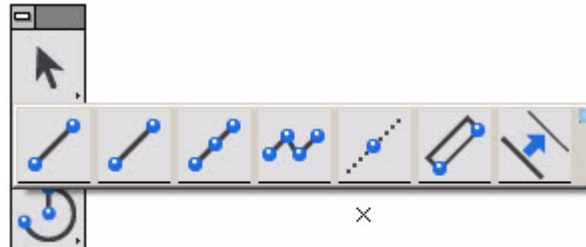

3. Drag the pointer to highlight the desired tool.
4. Release the mouse button.



The selected tool replaces the previous tool in the tool palette. The highlighted icon in the tool palette shows that the selection from the subpalette is the active or current tool.

The new tool is visible in the tool palette until another tool is selected from the same subpalette. The tools in the subpalette remain in the same order; only the tool displayed on the tool palette changes.



Once a tool is selected, additional information appears to help with the construction. The Pointer, Pointer Locator, Message Line, and Status Line all provide feedback about the active tool.

To select a tool that is already displayed in the tool palette just click it. It is unnecessary to select it from the subpalette.

### Tear Off Palettes

All tool palettes containing subpalettes are capable of tearing away from the parent palette. To tear away the subpalette from the parent tool palette click the small button in the upper right corner of the subpalette.



Move the subpalette anywhere in the drawing area. To save the palette in this location choose **Layout>Preferences>Save Palette**. Close the palette by double clicking on the left button in its title bar.

### Smart Pointer

When selecting a tool and moving the pointer in the drawing area, the pointer shape represents the selected tool.

Some of the pointers, like the single line pointer, are simple cross-hairs. Others, such as the Opposite-Point Circle pointer, resemble the tool itself.

The pointer, called a *smart pointer*, displays indicators for multi-step procedures. Each smart pointer has a dot, the *hot spot*, showing the next point to specify. The dot changes position on the pointer during each step of the construction.

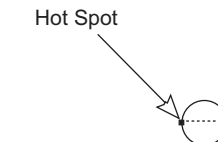

The smart pointer shows you where to click next.

For example, the Opposite-Point Circle pointer illustrated above shows that the first click of the mouse places a point on one edge of the circle being created. After clicking a location, the hot spot moves to the other side of the pointer, showing that the next click places a point on the opposite edge of the circle. (See the graphic above).

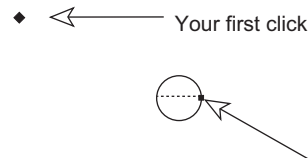

The hot spot moves to the other side of the smart pointer to indicate the next step.

After clicking the second location, the circle appears. The hot spot moves back to its original position on the pointer so that another circle can be created.

## Pointer Locator

The Pointer Locator is two numbers to the left of the horizontal scroll buttons at the bottom of the drawing area.

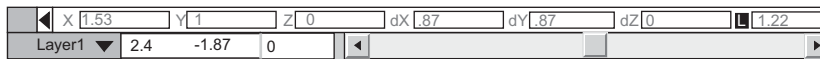

This locator continuously tracks the pointer location when the pointer is in the drawing area, displaying the X,Y coordinates of the current location relative to the origin. The origin (0,0,0) is in the center of the screen when a new document is opened. When making the grid visible by choosing **Layout>Show Grid**, a symbol appears at the origin (0,0).

## Message Line

The Message Line across the top of the drawing area provides concise instructions for the use of the selected tool.

For example, after selecting the **Center-Point Circle** tool, the Message Line appears as illustrated below:

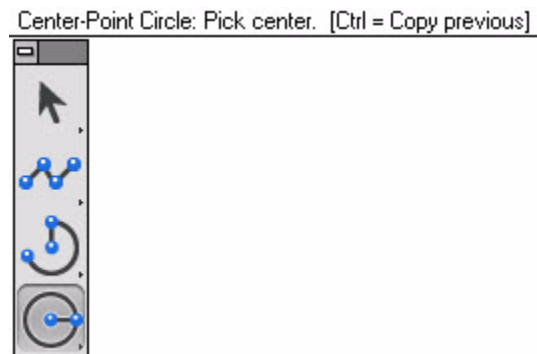

The instructions in the Message Line for some tools also indicate optional activities. For example, by holding down the CTRL (Windows) or OPTION (Macintosh) key while using the **Center-Point Circle** tool, the next mouse click creates a copy of the last circle with the center placed where the mouse was clicked.

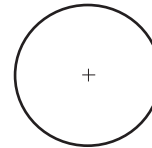

### *Tech Note:*

The number of decimal places displayed in the locator field is determined by the *Precision* setting in the Units dialog box (choose **Layout>Preferences>Units**).

The location indicator tracks the pointer position of any tool other than the **Selection** tool.

## Status Line

The Status Line provides measurements, angles, X,Y coordinates and delta values for the current construction. The current tool determines the number of status data fields and which of the status data fields is highlighted after the construction. For example, if the **Center-Point Circle** tool is selected, the Status Line shows the X,Y coordinates for the center of the circle and the length of the diameter.



When the last point of the circle is clicked, the diameter (D) data field highlights in the Status Line to indicate that it is active. It shows the diameter of the circle just created. If a new number is typed, and the ENTER (Windows) or RETURN (Macintosh) key is pressed, the diameter of the circle updates reflecting the change.

*Tip:*

Objects can be also changed with the *Edit Objects* command.

Entries can be changed in the Status Line, until the ENTER (Windows) or RETURN (Macintosh) is pressed.

The number of decimal places displayed in the status data fields is determined by the *Precision* setting in the Units dialog box (choose **Layout>Preferences>Units**).

### Moving Between Status Data Fields

Use the TAB key to move to the right, highlighting the next field. When pressing ENTER (Windows) or RETURN (Macintosh), the construction redraws according to the new specifications in the Status Line. The mouse is also used to activate a Status Line data field.

Use the Status Line arrows to scroll if any of the status data fields are off screen.

## Drawing Area

Use the drawing area for all construction, editing, and annotation of geometry. Think of the drawing area as a sheet of paper of unlimited size that is used to construct full-size unscaled drawings. Use the scroll bars to move the sheet so that the desired portion is visible in the window.

## Displaying the Grid

To work with a grid in the drawing area, choose **Layout>Show Grid**.

When the grid is visible, constructions snap to the grid, meaning that any geometry point clicked snaps onto the closest grid point. The coordinate symbol appears at the origin when the grid is visible.

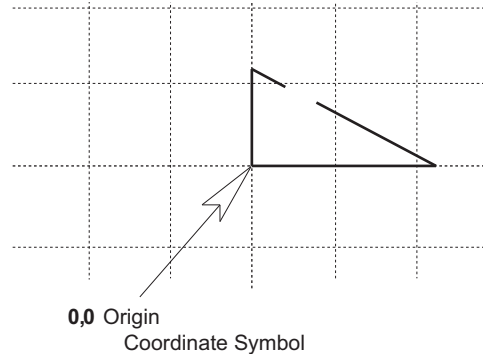

### Tip:

Normally, it is not necessarily to display the Grid, since the Drafting Assistant offers a more elegant support than the grid.

## Scroll Bars

The scroll bars move the sheet up and down or right and left. Display different parts of the drawing sheet by dragging the slider of a scroll bar to the approximate location. For example, the right, center, or left position in the horizontal scroll bar displays the right side, middle, or left side of the drawing, respectively.



Click the arrows at the end of the scroll bars to move the sheet one line at a time. Click in the scroll bar to move the sheet one window at a time.

## Work Layer Indicator

The work layer indicator in the lower-left corner of the screen shows which layer is the current work layer. New geometry goes on the work layer. For the construction to be on a specific layer, first make that the current layer.

To select a work layer, position the pointer over the work layer indicator, then press the mouse button. All available layers are then displayed in a pull-down menu from which a different layer can be selected as the current work layer.

Drag to the layer and release the mouse button. The selected layer becomes the work layer and all geometry being created will be placed onto that layer.

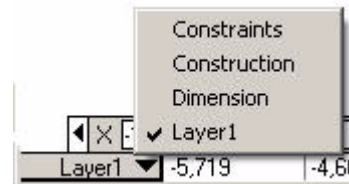

## Menu Bar

The Graphite menus contain related commands and settings.

<b>File</b>	Commands that affect entire documents (files).
<b>Edit</b>	Commands to select and manipulate objects.
<b>Layout</b>	Commands and settings that specify the drawing area and provide program features and functionality, such as construction lines and 2D analysis.
<b>Arrange</b>	Commands for zooming (to change the area displayed in the window) and setting specifications for objects.
<b>Pen</b>	Commands to specify pen characteristics (style, color, weight, and pattern), crosshatching, fill and arrows.
<b>Text</b>	Commands to set the font, size, style, alignment, and indentation of text and also to create text blocks and forms (title blocks).
<b>Dimension</b>	Commands that specify dimensions and their format and tolerance.
<b>Views</b>	Commands to control multi-page documents, including sheet manipulation and <i>View mode</i> . The menu also contains <i>Define View</i> , <i>View the Plane</i> , <i>Unfold View</i> , <i>Flatten View</i> and <i>Show Trackball</i> .
<b>3D</b>	Commands relating to the creation of geometry in three dimensions including planes and object rotation, as well as extruding and revolving of construction.
<b>Utilities</b>	Commands to add new functionality and to create and invoke macros.
<b>Window</b>	Commands to open the main tools palette, Dimensions palette, Pen Styles palette, Navigator palette, General palette.
<b>Help</b>	Commands that provide access to Graphite's PDF documentation and Ashlar-Vellum's Support Center.

### Displaying a Graphite Menu

1. Point to the menu name.
2. Click on the name.  
The menu appears. To dismiss the menu without making a choice, click outside the menu.

### Choosing a Command from a Menu

1. Point to the menu name.
2. Click on the name.  
The menu appears.
3. Click on the command.  
The command executes, or the setting, such as *Selectable Points*, toggles on or off.

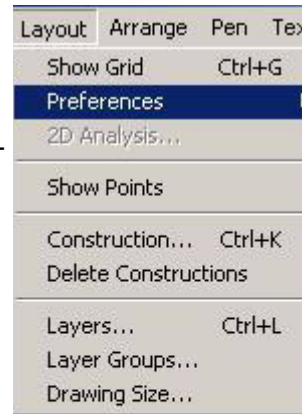

### Mouse versus Keyboard

Graphite's menu items are chosen with the mouse or with a combination of keys on the keyboard. For example, various methods are used for displaying the **Edit** menu.

#### Windows and Macintosh:

- Click on Edit in the menu bar.

#### Windows only:

- Press the ALT key and then type **E**.
- Press the ALT key and then press the RIGHT ARROW key until Edit is highlighted in the menu bar; then press ENTER.

There are also various methods for choosing commands with the keyboard. For example, use any of the following methods to choose **Layout>Show Grid**.

#### Windows:

- Press ALT and L and then type **G**.
- Press ALT and then use the RIGHT ARROW key to highlight Layout and press ENTER. Then press the DOWN ARROW key to move the highlighted area to *Show Grid* and press ENTER.
- Hold down the CTRL key and type **G**.

The first method is the *mnemonic method*. Press the ALT key with the appropriate letters for the menu and command as indicated by the underlined character in the names.

**Macintosh:**

- Hold down the ⌘ COMMAND key and type **G**.

The third method for Windows, and the only one available for Macintosh, is a keyboard accelerator. When available it is denoted by the key sequence listed on the menu.

While keyboard functionality is always available, this manual generally describes making choices with the mouse.

**Submenus**

Commands followed by an arrow have submenus which display when the command is highlighted.

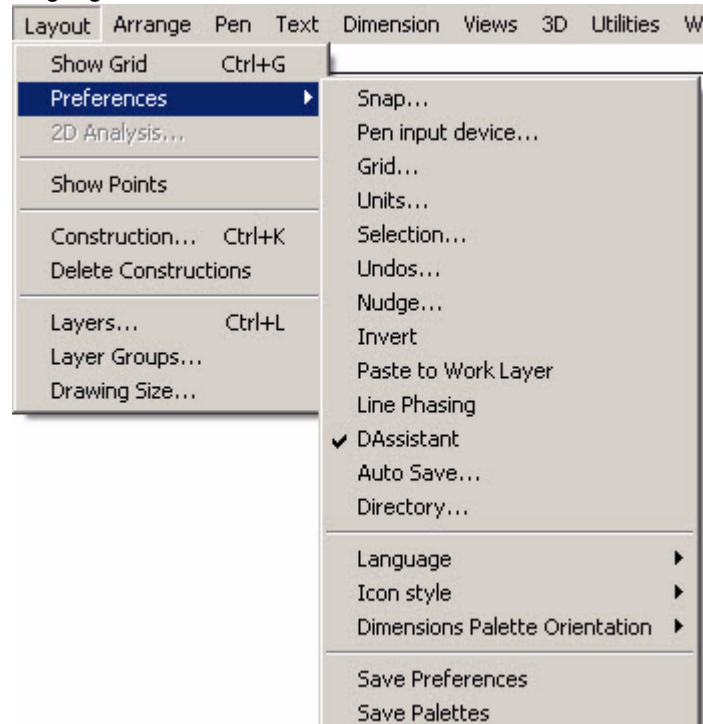

1. Pull down the menu.
2. Click on a command with an (arrow) on the end.  
The submenu displays.
3. Click on the submenu.
4. Click the desired command.



### Dialog Boxes

When choosing a command followed by an ellipsis (...), such as *Edit Objects* in the Edit menu, a dialog box appears.

Dialog boxes qualify the command chosen by adding information. For example, in the Edit Objects dialog box on the right, the specifications of the selected object are changed.

If a dialog box obscures the view of the drawing area, move it to a new location by dragging it with the pointer on the Title bar.

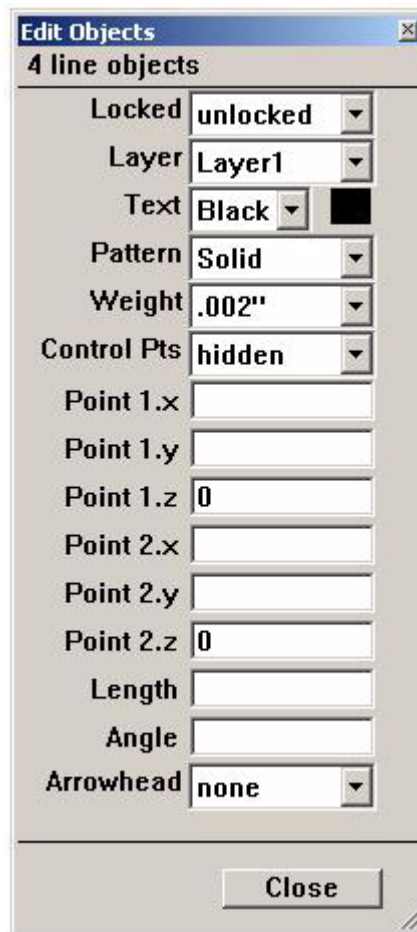

### Option Buttons

Option buttons indicate mutually exclusive choices; select only one option at a time. Click the desired option and the button turns black, as shown by the inches option below.

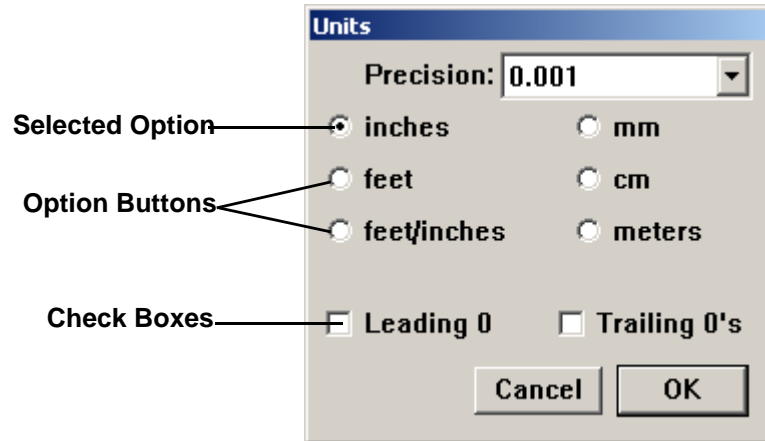

### Check Boxes

Check boxes, as shown above, provide options to switch on and off and which are not mutually exclusive. A check shows the option set.

### List/Entry Boxes

Some dialog boxes contain lists of options, displaying an arrow to provide access to the list.

If the entry includes an arrow, it displays a menu which works like a submenu on the menu bar displaying the selected item in the box.

Some list boxes also allow an entry to be typed. For example, type a value in the *Scale* data field in the Drawing Size dialog box or choose from the pop-up menu. See the graphic below.

Drawing Scale

To type an entry, select the current entry (if it isn't already selected), then type a new entry. In most cases, clicking on the OK button, saves the changes.

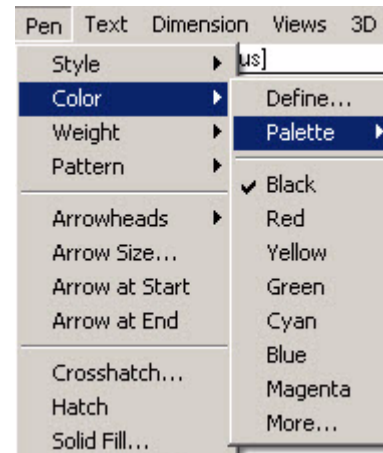

#### Tip:

Windows: An alternative is to hold down the ALT key and type a letter to select the first item that begins with that letter, then use the arrow keys to move to the desired selection. Once it is highlighted, press ENTER.

### Asterisks

When an item in the dialog box displays an asterisk (\*), a value can be specified by clicking or dragging in the drawing area. This feature is particularly useful for specifying location because knowing the x, y coordinates is not necessary.

### Apply Buttons

Some dialog boxes have an Apply button so that the specification can be activated and left open for setting further specifications.

For example, crosshatch a part then leave the Crosshatch dialog box open to crosshatch other objects.

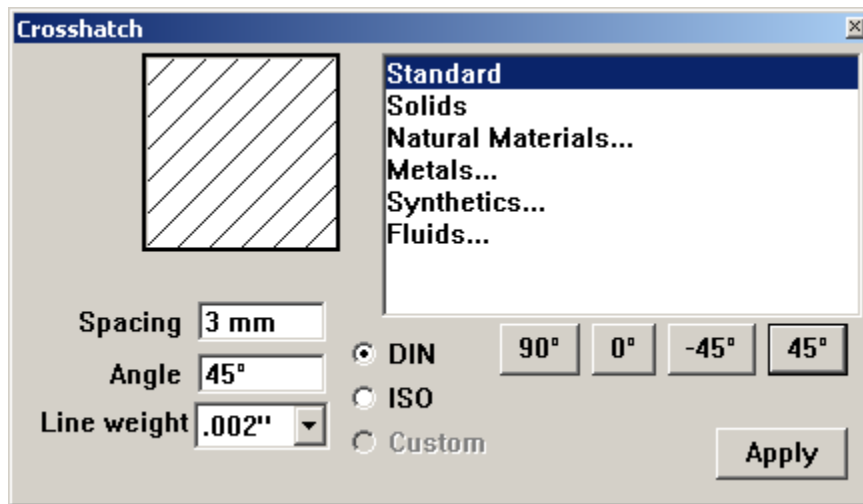
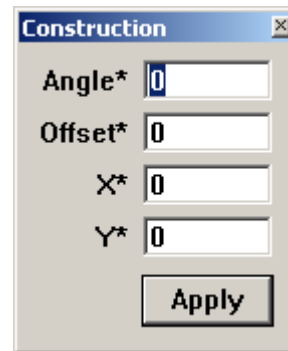

### Closing a Dialog Box

If a dialog box contains an OK or Cancel button or an action button such as Open, the dialog box closes after clicking the button. Otherwise, to dismiss the dialog box manually double-click the Control Menu (Windows) or click the Close Button (Macintosh) in the upper-left corner of the box. If the dialog box has an Apply button, such as the Crosshatch dialog box above, you must dismiss it manually.

### ***Toggling Commands***

Commands that set a condition (such as *Selectable Points* and *Arrow At Start*) display a check mark in the menu to indicate that they are active. To turn a command off, choose it and the check mark disappears.

In the case of pen styles and text characteristics, the check shows the current setting.

Other commands, *Show Grid*, *Show Points*, *Show Palette*, *Show Trackball* and *Show Triad* toggle to *Hide* (Grid, Points, Palette, Trackball or Triad) when the component is visible.

## Preferences

All files are saved with their settings when choosing **File>Save**. The characteristics used for new files (the default settings) are contained in the preferences file. The preferences filename is *prefs.vc6* (Windows) or *Graphite prefs* (Macintosh). Change the default settings so that every new document opens with the desired settings. The following specifications are set in the preferences file:

- Pen styles
- Text characteristics
- Preference settings (snap, grid, units, selection color indicator, visualization, palette status and palette location)
- Grid display
- Layer and sheet specifications
- Work layer
- Dimension and tolerance formats
- Arrowhead type and display
- Drawing size and scale
- Zoom scale
- Fillet radius
- Chamfer angle and length
- Resolve values

The default value of any setting that can be changed on a menu or in a dialog box can be set in the preferences file.

### Changing the Default Settings Manually

1. Open the preferences file (it's in the same folder as the Graphite application).
2. Change the characteristics and, if needed, create the layers and sheets.
3. Save and close the file.

The file must be stored in the same folder as the Graphite application.

The preferences are set for subsequent new documents.

The settings will not take effect until the next time you launch Graphite.

### Changing the Default Settings with Save Preferences

1. Open a new Graphite file.
2. Set the preferences as needed.
3. Choose **Layout>Preferences>Save Preferences**.

The preferences are set for this file. The settings for future files take effect the next time you launch Graphite.

**Important:** It is advisable to use *Save Preferences* only before starting to draw. Otherwise, undesired data may be saved in new files. For example, if *Save Preferences* is chosen on a file with a detail view and multiple models, all new files will contain a detail view window and multiple models.

### Changing the Icon Style

The icon style has been updated. The new style is set by default. To use the Classic or Modern icon style instead choose

**Layout>Preferences>Style>Classic.**

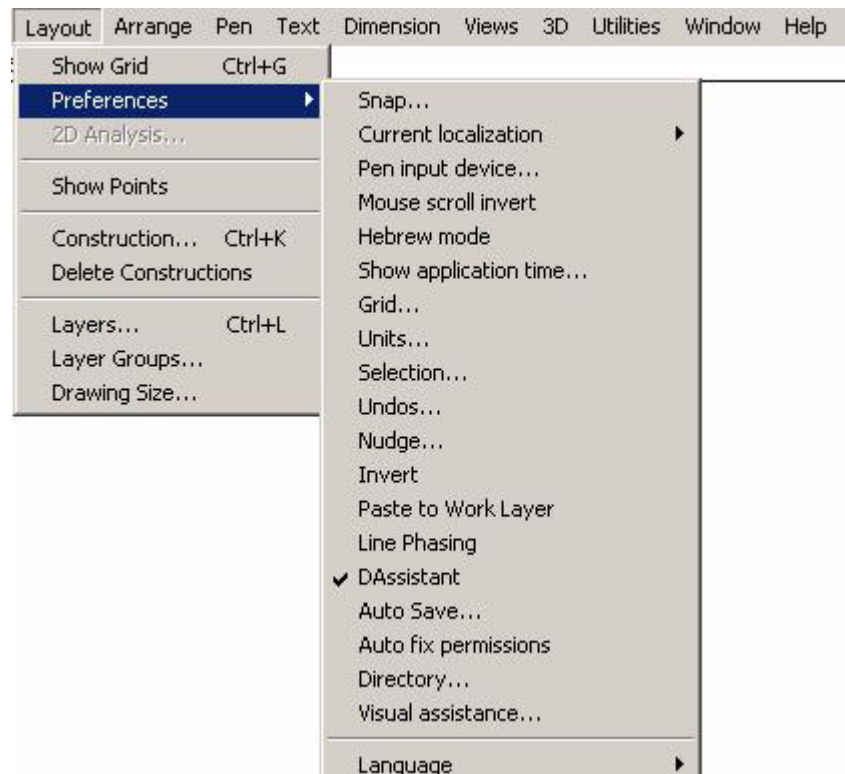

# The Drafting Assistant

The Drafting Assistant makes Graphite unique among design and drafting software products. The Drafting Assistant thinks like a drafter; it automatically *knows* where construction lines are typically wanted and temporarily displays them when needed.

The Drafting Assistant also makes it easy to select existing points for construction by displaying information about the pointer's location in the drawing area. If a Drafting Assistant notation displays when clicking, the construction snaps onto the geometry precisely, without requiring finely tuned eye-hand coordination or tedious selection of special modifiers, modes, or other specialized construction tools.

The following topics are covered in this chapter:

- Snapping to Geometry
- Drafting Assistant Construction Lines
- Permanent Construction Lines

## Snapping to Geometry

When the pointer is in the drawing area, it has a snap point function. The snap point locks onto specific points on existing objects as the pointer moves near them.

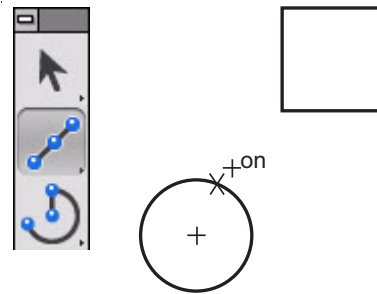

The Drafting Assistant snapping onto a circle

The Drafting Assistant tells when the snap point is *on* an object.

It displays information about the location of the snap point. This information appears either beside the pointer or next to the object itself.

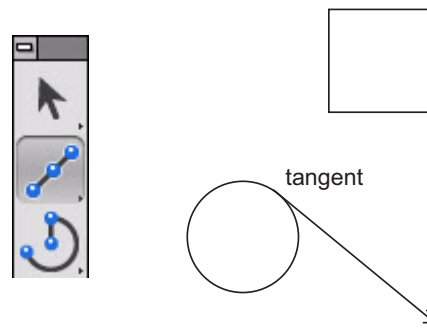

The Drafting Assistant displaying the relationship between the circle and the line that is being constructed.

The Drafting Assistant tells when the snap point has locked onto the points of an object as follows:



**center**

The center of an arc or circle. Move the pointer across the arc or circle to display *on* for the arc or circle, then move the pointer near the center to display the *center* point notation.

**endpoint**

The endpoint of lines, arcs, circles, ellipses and splines.

**midpoint**

The midpoint of lines, arcs, circles, ellipses and splines.

**intersection**

The intersection of two curves or lines, including permanent lines and the Drafting Assistant's dynamic construction lines.

**quadrant**

Quadrant points on an arc or circle displayed at 3 o'clock, 6 o'clock, 9 o'clock and 12 o'clock.

**vertex**

The vertices of an ellipse, spline, or dimension point.

### Using Tangents and Perpendiculars

By clicking a point *on* an arc or circle and dragging the pointer away at about a 45° angle, the Drafting Assistant locks onto the *tangent*. If you drag away at a 90° angle the Drafting Assistant locks onto a *perpendicular*.

#### Tangent

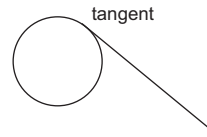

#### Perpendicular

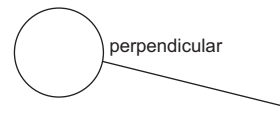

Continue holding the mouse button, and the line remains *tangent* or *perpendicular* while dragging the ending point around the object.

This is a useful feature if, for example, it is necessary to create a line from and tangent to an existing circle to the tangent point of another circle.

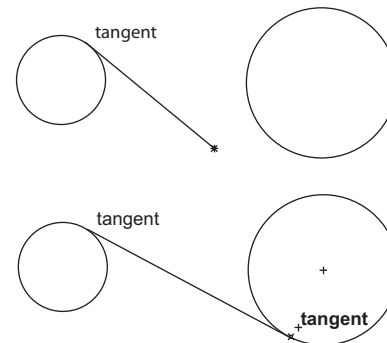

Once a line is *tangent* to the circle, it can be dragged to the tangent point on the other circle, with the tangency maintained at both ends.

The Drafting Assistant locks onto a *tangent* or *perpendicular* only when the Drafting Assistant starts from the *on* notation. It is possible to begin a tangent or perpendicular line from a specific point, such as *endpoint*, *quadrant* or *vertex*.

## Keyboard Snap Points

It is possible to direct the Drafting Assistant to snap onto an object. For example, to start a new line from the exact center of a circle. Hold down the mouse button and press the **C** key on the keyboard. The Drafting Assistant finds the *center* of the circle when moving the pointer near the center.

### *Using the Drafting Assistant for Snapping onto Geometry*

The following table lists the keys for finding specific points. The desired point must be within the Hit Radius (defined later in this chapter) of the pointer. Press the mouse button first and then press one of the following keys on the keyboard.

Keyboard snap points only work when there are multiple snap points within the Hit Radius of the pointer.

Letter	Snaps To (Align)
<b>c</b>	center
<b>e</b>	endpoint
<b>g</b>	grid
<b>i</b>	intersection
<b>m</b>	midpoint
<b>n</b>	no point
<b>o</b>	on
<b>p</b>	perpendicular
<b>q</b>	quadrant
<b>t</b>	tangent
<b>v</b>	vertex
<b>%</b>	the percentage point set in the Snap dialog box

Pressing the SPACEBAR or clicking the mouse releases all snap restrictions.

Keyboard snap points act as a filter. For example, to place the end of a line at the center of a circle where the intersection of two other objects lies near the center (within the specified Hit Radius), the Drafting Assistant does not know which point—the *center* or the *intersection*—to snap to. By pressing the **C** on the keyboard while dragging the line, the Drafting Assistant knows to snap to *center* and to disregard the *intersection* (or any other snap point that falls within the Hit Radius).

#### *Tech Note:*

Another way to create geometry from an exact location relative to another object is to reduce the Hit Radius of the Drafting Assistant with a lower number of pixels or to zoom in on the drawing to separate the construction points visually.

## DAssistant Command

This command, found in

**Layout>Preferences**, turns the Drafting Assistant on or off. When the Drafting Assistant is not checked in the menu, the Drafting Assistant is off.

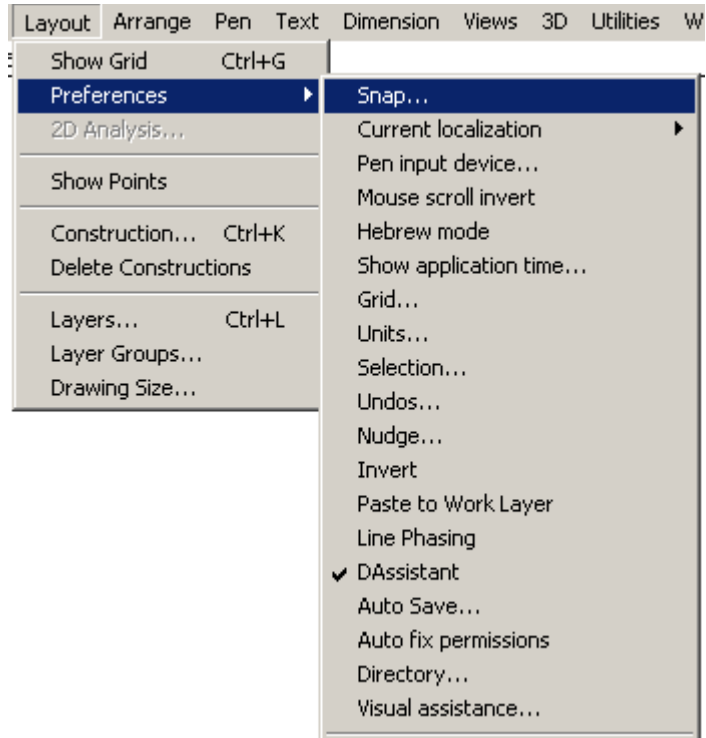

## Snap Basic Command

This *Snap* command, found in **Layout>Preferences**, sets specifications for the Drafting Assistant.

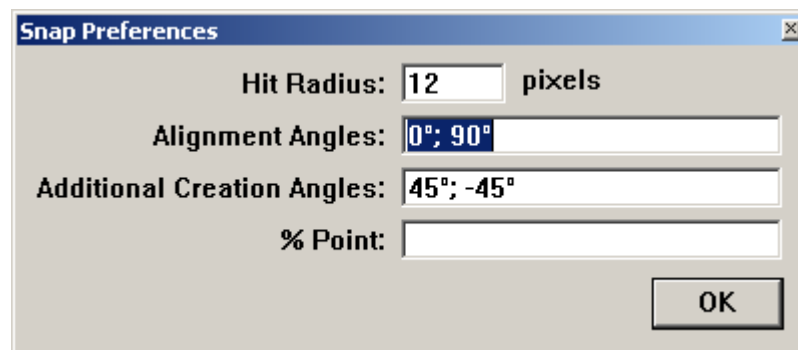

## Hit Radius

This setting determines the detection distance in pixels. When the pointer is within the specified Hit Radius, the Drafting Assistant notations display and the object is selected when the mouse is clicked. The default Hit Radius is 12 pixels.

If specifying locations becomes difficult because they are close together and the Drafting Assistant snaps to an existing control point, do any of the following:

- Decrease the Hit Radius.
- Zoom in so more pixels separate the existing point and the point to select.
- Lock on a point by pressing the mouse button and then typing the letter that represents the point (**m** for *midpoint*, for example).

If the Hit Radius is set to zero, it disables the single click selection of the **Selection** tool. Dragging a selection fence and double-clicking to select all objects still works). Instead, consider using the *Selection Mask* in the Edit menu to specify that some objects cannot be selected.

## Alignment Angles

These angles define the dynamic construction lines that the Drafting Assistant automatically uses. To change the orientation of the drawing, change these specifications. For example, set these angles to 30°, 90° and 150° for an isometric drawing. The defaults are 0° (horizontal) and 90° (vertical). Use a semicolon to separate the values. Up to 16 angle values can be set in the Alignment Angles field.

To display a temporary construction line through a point, activate the point by moving the pointer to it. A diamond appears when you move your mouse away from the point. Construction lines automatically display through the active point. Up to eight points are active at one time. When the ninth point is activated, the first one in the series deactivates.

**Additional Creation Angles** These lines are used by the Drafting Assistant only when creating geometry and they are not part of the list of lines generated from the eight active points. The defaults are 45° and -45°. Use a semicolon to separate the values.

**% Point** These are the divisions of a line for Drafting Assistant notations. To divide the line into quarters, use a 25 specification. The default is 50, which shows the *midpoint* of lines.

For example, entering 60 instructs the Drafting Assistant to tell when the pointer is 60% of the distance along a line as shown below.



## Snap Mode Command

The *Snap* command is available by going to **Edit>Snaps Filter**. This command activates and deactivates the different snap modes of the Drafting Assistant. This command is different from the *Snap* command, chosen through the **Layout>Preferences** menu, that sets basic specifications of the Drafting Assistant.

Choosing **Edit>Snaps Filter** displays the following dialog box:

All snap modes are activated by default. To deactivate a snap mode click the related check box.

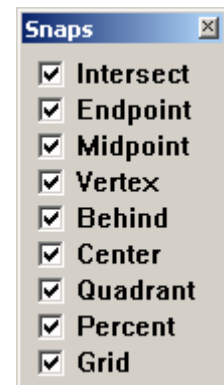

## Drafting Assistant Construction Lines

In addition to snapping to geometry, the Drafting Assistant also displays *dynamic construction lines*. Three types of construction lines are used most frequently: vertical, horizontal, and 45° angle lines. These display automatically during construction. Construction lines appear temporarily to help align geometry. Once a point is set, the Drafting Assistant construction line disappears so that the drawing is not cluttered with extraneous lines.

Dynamic construction lines extend automatically from the last point created. To activate other points so the Drafting Assistant displays construction lines relative to them, simply move the pointer over the geometry to activate or “wake-up” its control points, then move away horizontally or vertically.

Of course, there is the option of creating *permanent construction lines* and other shapes, as described later in this chapter.

### Using the Drafting Assistant’s Construction Lines

Indicate the first endpoint of a line and move the pointer horizontally, vertically, or in a 45° direction, the dynamic construction lines appear. The figure here illustrates a 45° construction line relative to the endpoint of an existing line.

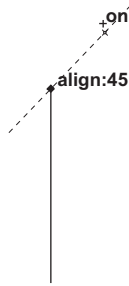

### Displaying Dynamic Construction Lines while Constructing Geometry

1. Click a point to begin new geometry.
2. Move the pointer away from the point horizontally, vertically, or at a 45° angle.
3. While the construction line is visible and the Drafting Assistant displays *on*, click the next point.

The point is placed exactly on the construction line, even though the pointer wasn't exactly on that line when clicked. The dynamic construction line disappears.

### ***Displaying Dynamic Construction Lines with Existing Geometry***

1. Without pressing the mouse button, move the pointer over an existing point.

The point notation (*endpoint* or *midpoint*, for example) shows that the point is active.

2. Move the pointer horizontally or vertically.

A construction line appears through the point.

3. While the construction line is visible and the Drafting Assistant displays *on*, click the desired point in the construction.

The point is placed exactly on the construction line, even though the pointer wasn't exactly *on* that line when clicked. The dynamic construction line disappears.

The figure here illustrates intersecting construction lines drawn through two existing, active points.

#### *Tech Note:*

Up to eight active points are available. Activating the ninth point in a series deactivates the first point.

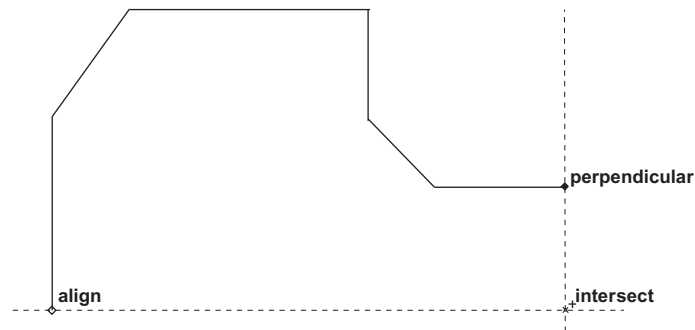

Once familiar with the Drafting Assistant, Graphite will streamline design and drafting tasks.

### ***Setting New Drafting Assistant Construction Angles***

Add to or change the angles that the Drafting Assistant uses for dynamic construction lines by choosing **Layout>Preferences>Snap**. Enter the construction line angles, separated by semicolons, in the appropriate data field.



## Permanent Construction Lines

In addition to the Drafting Assistant's dynamic construction lines, it is possible to create construction lines that display until hidden or removed. There are three methods for creating permanent construction lines: strokes, with the **Construction Line** tool and the *Construction* command in the Layout menu. Construction lines automatically appear on the construction layer, not the work layer of the drawing. Hide the construction layer to view or print the drawing without construction lines.

To remove all construction lines, choose **Layout>Delete Constructions**. Everything on the construction layer deletes, regardless of the object's pen style.

### Stroke Construction Lines

Stroke construction lines are lines that are created with the mouse. Hold down the CTRL+SHIFT keys (Windows) or the ⌘ key (Macintosh) and drag the mouse horizontally or vertically. The Drafting Assistant helps to place the stroke precisely.

Holding down the CTRL+SHIFT keys (Windows) or the ⌘ key (Macintosh) changes the mouse pointer to the Stroke point (⌘).

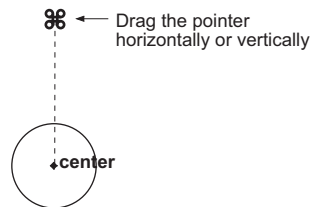

#### Drag

#### Vertically

#### Horizontally

#### Result

A vertical construction line through the first point of the stroke.

A horizontal construction line through the first point of the stroke.

#### Referral:

For using the **Construction Line** tool see "Construction Lines Tool" on page 7-13

#### Referral:

More information on Layers is found in Viewing Geometry

#### Tip:

Use strokes to create construction lines while you are in the process of using another tool.

## Using Stroke Construction Lines

Construction lines are as long as the dimensions of the viewing area of the screen or the plot region (as designated in Drawing Size dialog box in the Layout menu), whichever is larger.

For example, if using the **Connected Lines** tool to create a construction line that extends through the center of a circle:

1. Hold down the CTRL+SHIFT keys (Windows) or the ⌘ key (Macintosh). The pointer becomes the Stroke pointer (⌘).
2. Move the pointer near the *center* of the circle.  
The Drafting Assistant snaps onto the center point.
3. Drag the mouse vertically or horizontally away from the *midpoint*.

The construction line appears through the *center* while still in the process of creating connected lines. Releasing the CTRL+SHIFT keys (Windows) or the ⌘ key (Macintosh) and continue working.

### Tech Note:

Graphite automatically places construction lines on the construction layer. When choosing **Layout>Delete Constructions**, everything on the construction layer is deleted, regardless of the object's pen style.

## The Construction Command

Stroke construction lines are useful for creating lines through existing points. To create a construction line at a location other than an existing point or at a particular angle, use the *Construction* command.

### Using the Command CTRL+K (Windows) ⌘+K (Macintosh)

This command in the Layout menu creates a construction line on the construction layer of the document.

Specify the angle of the construction line or the offset from a reference point defined by the X, Y coordinates. The asterisk shows that the values are specified by clicking or dragging the mouse. Values are also typed into the data fields.

The distance dragged is always entered in the Offset data field as a positive value, regardless of the direction dragged.

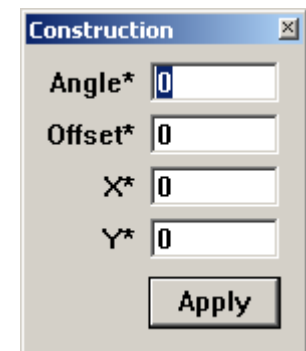

Any geometry placed on the Construction layer will not have a Midpoint snap. This is by design so that construction data will not confuse the user's work area. It is not advisable to create a drawing on the Construction layer because there is no Midpoint snap and because the **Layout>Delete Construction** will delete all

geometry on this layer. The Construction layer is really used for Graphite to store construction line data and should not be used for regular geometry.

### Specifying the Construction Line Angle with the Mouse

1. Click the *Angle* data field.
2. Drag a vector in the drawing area.

The angle of the vector line appears in the *Angle* data field.

### Specifying the Construction Line Offset with the Mouse

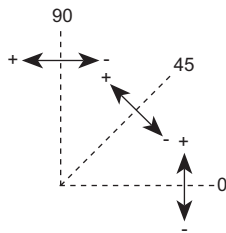

1. Click the *Offset* data field.
  2. Drag the offset distance in the drawing area.
- The distance dragged appears in the *Offset* data field. The offset is determined by the angle of the construction line as shown.

### Specifying X,Y Coordinates with the Mouse

The coordinates of the last point specified appear in the X and Y data fields. To change them, do the

following:

1. Click the X data field.
2. Enter new coordinates, or

In the drawing area, click the location of the point through which the construction line will pass. The coordinates are entered automatically for the X and Y data fields.

### Creating Multiple Construction Lines

Create multiple construction lines through the same point by entering the angles separated by semicolons.

### Creating Parallel Construction Lines

Create parallel construction lines by specifying a single angle value with different offsets separated by semicolons. It is also possible to create parallel lines by creating one construction line using this data field, then creating new lines with the **Parallel Lines** tool.

## Creating Construction Geometry

Non-construction geometry is placed on the work layer. Create temporary construction geometry, such as arcs or circles, by making the construction layer the work layer, creating the construction geometry and then switching to another layer to continue working.

Use the Construction pen style if desired, but it's not essential.

Lines made with the Construction pen do not go on the construction layer unless that layer is the work layer.

### Creating Construction Geometry

1. Choose **Layout>Layers**.

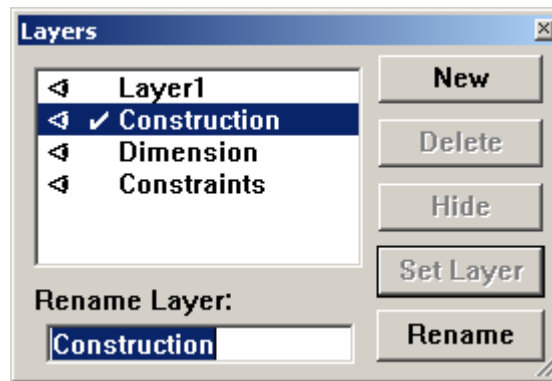

2. Click Construction in the list box.
3. Click Set Layer.
4. Create the geometry for construction. Use the Construction pen style if desired.
5. When the construction geometry is complete, make another layer the work layer.
6. Close the dialog box.
7. Continue to work.

*Tip:*

Select construction lines in the usual manner from any layer. The construction layer doesn't have to be the work layer.

Once the construction geometry is no longer needed, choose **Layout>Delete Constructions** to remove all geometry on the construction layer.

## Removing Construction Lines

To delete only one or two construction lines among many, select the lines to remove, and then choose **Edit>Delete** or press the BACKSPACE (Windows) or DELETE (Macintosh) key. To remove all the construction lines created, choose **Layout>Delete Constructions**.

### **Delete Constructions**

This command in the Layout menu deletes all construction lines and any geometry on the construction layer. The Drafting Assistant's dynamic construction lines appear only temporarily and are not affected by this command. Any geometry on the construction layer (regardless of the pen style used) is deleted by this command.

Retrieving the deleted construction geometry is possible with the *Undo* command.



# Basic Environment Settings

This chapter describes the options for adapting Graphite to your needs. The following topics are covered:

- Pen Styles
- Pen Characteristics, including the Color Palette
- Setting Units
- The Grid
- Drawing at Full Scale
- The Drafting Process
- OS Settings
- Saving Preferences
- Save Palettes

## ***Pen Styles***

The pen style determines the appearance of lines on the screen and during plotting. Using a monochrome monitor or printer, all lines are black but the weight and pattern are visible. Any line thickness of less than .016 inch appears one pixel wide on the screen. When printing or plotting such lines, you will see that the different weights are observed.

The default pen style is Outline—solid, black lines, .01 inch wide. Change to a different pen style or change an individual characteristic of the current pen.

Choose from nine different pen styles in the Pen menu. The characteristics are listed below.

Pen	Pattern	Weight	Color
Outline	Solid	0.010	Black
Visible	Solid	0.020	Black
Hidden	Hidden	0.016	Red
Dash	Dashed	0.016	Yellow
Center	Center	0.010	Green
Phantom	Phantom	0.010	Cyan
Dimension	Solid	0.002	Blue
Balloon	Solid	0.005	Green
Construction	Dotted	0.002	Magenta

To change pens, choose among four options:

- Choose **Pen>Style** from the menu and select a different pen style from the list. The current pen style is checked.
- Choose a pen from the Pen Style palette accessed under **Windows>Show Pen Styles Palette**.
- Choose different characteristics for the current pen from the pen characteristics listed in the Pen menu (Color, Weight and Patterns)
- Use **Pen>Style>Edit Style** to permanently alter the characteristic of the pen.

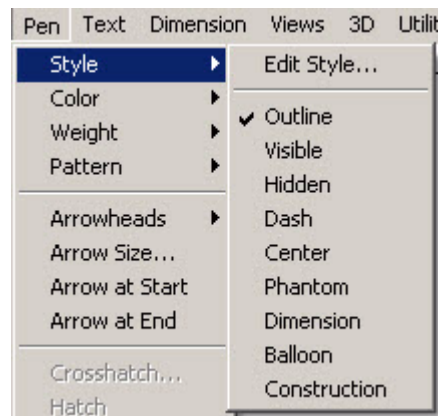



## Changing the Pen Characteristics of an Object

1. Select the object.
2. Choose **Pen>Style** and select the pen style to change the characteristics of the selected object. To change one characteristic rather than the entire pen style, choose the characteristic from the pen characteristics listed in the Pen menu.

When changing this, the current pen also changes, thus affecting future constructions.

To change the pen characteristics of an object without changing the current pen, select the object, then choose **Edit>Edit Objects** and change the characteristics in the dialog box.

## Pen Characteristics

The following characteristics are available from the submenus in the Pen menu.

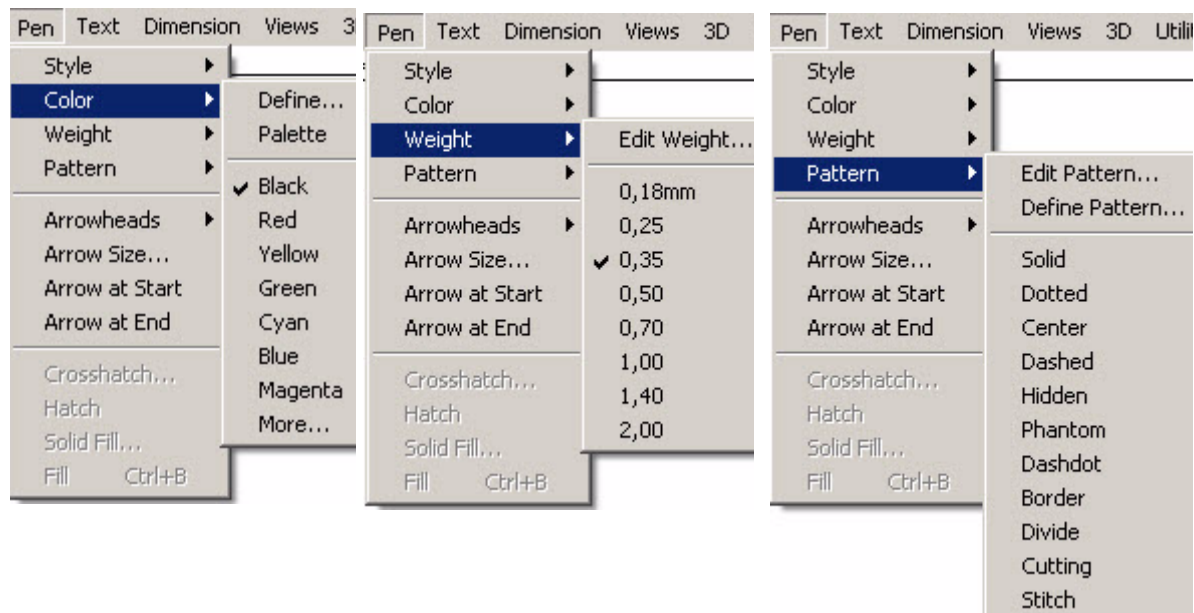

## Color

There are 234 color options including 170 user definable colors and 64 predefined colors. This **Color** palette displays the 64 predefined colors in **Pen>Color>Palette**.

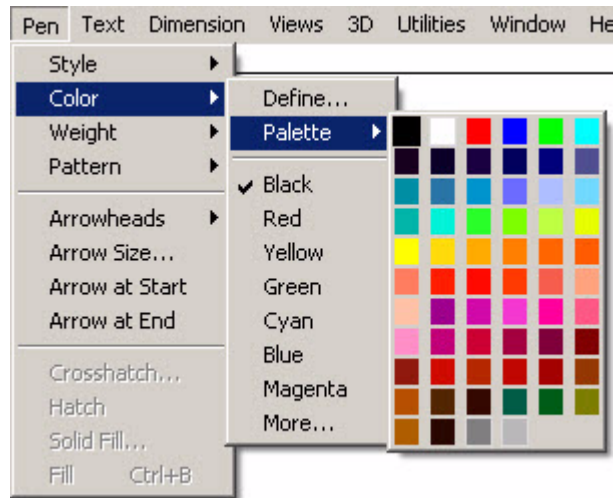

Each definable color can be independently assigned from the 16.7 million colors available.

This *Color* command specifies the color of the current pen and any other selected geometry without changing any other pen characteristics.

### Specifying the Color of the Current Pen

1. Choose **Pen>Color**. The submenu appears.
2. Choose the color.  
The pen takes on the new color as selected in the submenu.
3. Deselect any geometry to see the chosen color.

## Defining Colors

As many as 234 colors may be defined. By choosing **Layout>Preferences>Save Preferences** following their definition, they are available each time a new file is opened.

Because the color displays are different for Windows and Macintosh machines, the process for defining a color vary slightly. See your Windows or Mac documentation for information on how to define custom colors on your platform.

1. To define a new color, choose **Pen>Color>Define**.

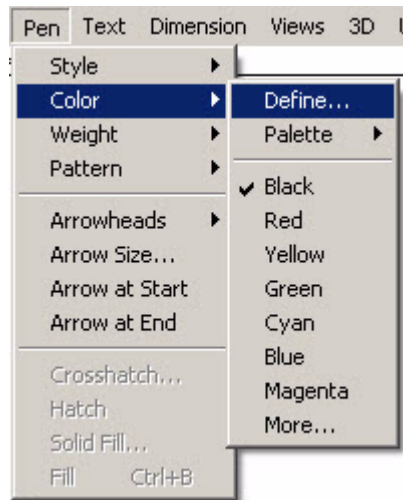

- The Edit Colors dialog box appears.

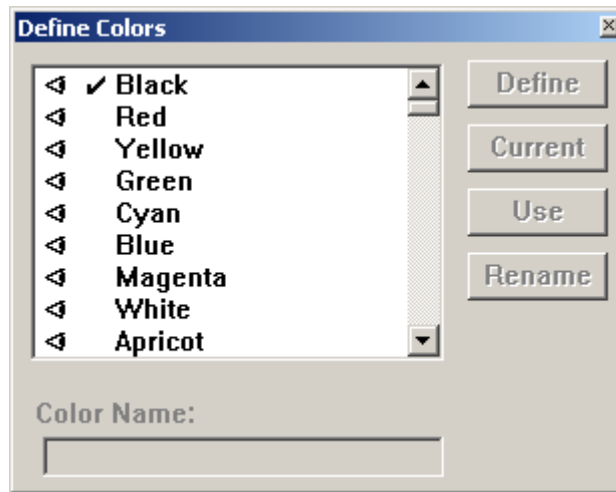

- In the dialog box window, scroll down and select one of the undefined color numbers, like <User65> (the first definable color available).
- Enter the color name in the *Color Name* data field and click Rename. The name entered replaces User <65> in the colors list, as displayed here.
- Click Define. The color display appears on the screen.  
Follow the directions in your Windows or Mac operating system documentation on to create custom colors.
- When you have finished creating any custom colors, save these colors as default color settings for all new files by choosing **Layout>Preferences>Save Preferences**.

*Tech Note:*

The 64 predefined colors that came with Graphite cannot be redefined or edited.

## Editing User-defined Colors

Edit the previously defined colors using a procedure similar to that for defining colors.

- Choose **Pen>Color>Define**.
- The Define Colors dialog box appears.
- In the dialog box window, scroll down and select one of the defined colors.
- Click Define. The color display appears.  
Edit the color.
- Click OK to save the changes.

## Saving Colors

Choose **Layout>Preferences>Save Preferences** to save the colors defined. Colors created for a specific file are saved with the file if they have not been saved using *Save Preferences*.

## Customizing the Color Palette

This feature designates which colors display in the **Palette** when choosing **Pen>Color>Palette**.

### Displaying a Color in the Palette

1. Choose **Pen>Color>Define**.
2. Select the color to display.
3. Click Use. An eye icon appears next to the color name.

Click in the blank space to the left of the name to display the icon.

Choose **Pen>Color>Palette** to see that the color patch has been added to the palette.

### Removing a Color from the Palette

1. Choose **Pen>Color>Define**.
2. Select the color to remove.
3. Click No Use. The eye icon next to the color name is removed.

Click on the eye icon to remove it.

When choosing **Pen>Color>Palette**, the color patch has been replaced by a patch with an X in it.

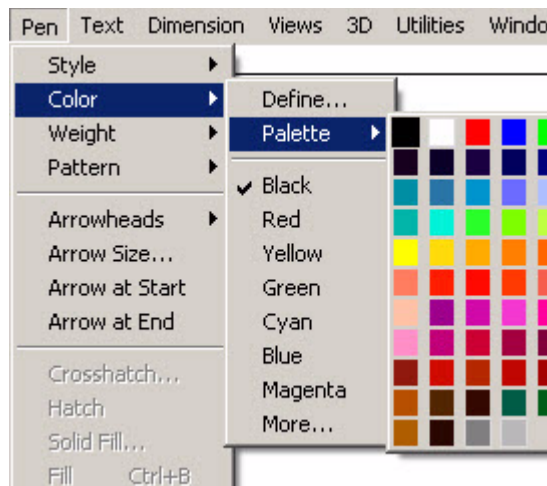

## Weight

This command in the Pen menu sets the pen width of the current pen and selected lines without changing any other pen characteristics.

The line weights shown in this submenu depend on the units selected in the Preferences submenu. If metric units are selected, the line weight is shown in millimeters instead of inches.

**Note:** Any line thickness that converts of less than .016 inch in your resolution appears one pixel wide on the screen. When printing or plotting such lines, the different weights are seen.

### Specifying a New Weight for the Current Pen

1. Choose **Pen>Weight**. The submenu appears.
2. Drag to the desired weight.

The pen takes on the new weight, as selected in the submenu.

### Edit Weight Command

This command from the Weight submenu in the Pen menu sets the line weights. Graphite comes with eight default line weights ranging from .002" (.05mm) to .050" (1.27mm). Objects drawn in Graphite are drawn in one of the eight available pen weights. Choose **Pen>Weight>Edit Weight** to change the weight of one of the pens to any value between .001" (.0254mm) to .050" (1.27mm).

There cannot be more than eight different pen weights in a drawing, so changing a pen weight in the Edit Pen Weights dialog box changes the weight of every object drawn with that pen's previous weight.

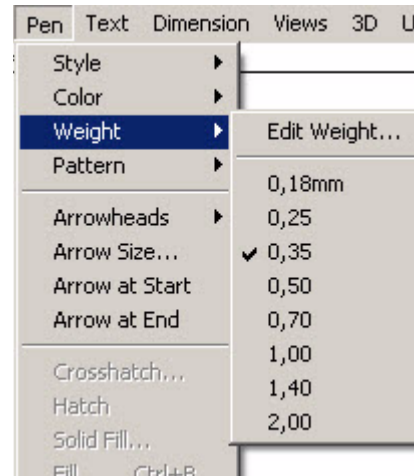

### Editing Pen Weights

1. Choose **Pen>Weight>Edit Weight**. The Edit Pen Weight dialog box appears.
2. Select the pen weight to change by clicking on the pen number. That pen's data field is selected.

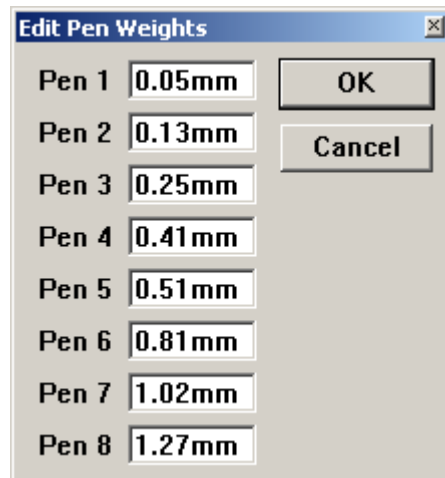

3. Change the pen weight by typing a new value into the data field. If no units are given with the entry, Graphite applies the unit specified in the Units dialog box from Preferences.

If the entry does not fall within the valid range from 0.0001" (.00254mm) to 5" (127 mm), Graphite prompts with an Alert box similar to the one here.

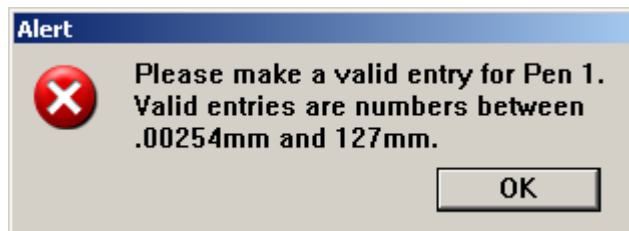

**Note:** While Graphite will accept any entry between these values, most printers will not print a line over 0.5" (1.27mm), nor will the screen display anything less than 1 pixel.

Clicking OK in the Alert box returns to the Edit Pen Weights dialog box to make the necessary changes.

4. Click OK in the Edit Pen Weights dialog box. All existing lines drawn in the pen weight that was edited change to reflect the new weight, as will all future lines drawn in that pen weight.

Clicking Cancel ignores all changes made to any pen weights and closes the Edit Pen Weights dialog box.

### **Undoing a Pen Weight Edit**

Do not undo editing a pen weight with the *Undo* command. To return a pen to Graphite's default, enter the original value in the Edit Pen Weight dialog box, following the steps described above.

The default weights are: Pen 1 - .002", Pen 2 - .005", Pen 3 - .010", Pen 4 - .016", Pen 5 - .020", Pen 6 - .032", Pen 7 - .040", Pen 8 - .050".

Edited pen weights affect only the pen weights in the current file. To save the edited pen weights so that they are available in all future files, choose

***Layout>Preferences>Save Preferences.***

#### *Tech Note:*

Remember that all pen weights thinner than .015" appear on the screen as one pixel thick. It is possible to see the difference in pen weights on the prints and plots.



## Pattern

Graphite provides eleven standard line patterns and the ability to create nineteen additional line patterns. Using the *Pattern* command, set the pattern of the current pen and any selected lines without changing any other pen characteristics. Define new patterns and edit all line patterns currently available.

### Specifying a New Pattern for the Current Pen

Choose a standard line pattern or a user-defined pattern. When selecting a pattern, regardless of whether an object is selected, the pattern becomes the current pen. If a particular pen style had been previously chosen, notice that style is no longer checked in the pen style submenu.

### Setting a Standard Pattern

1. Choose **Pen>Pattern**. The submenu appears.

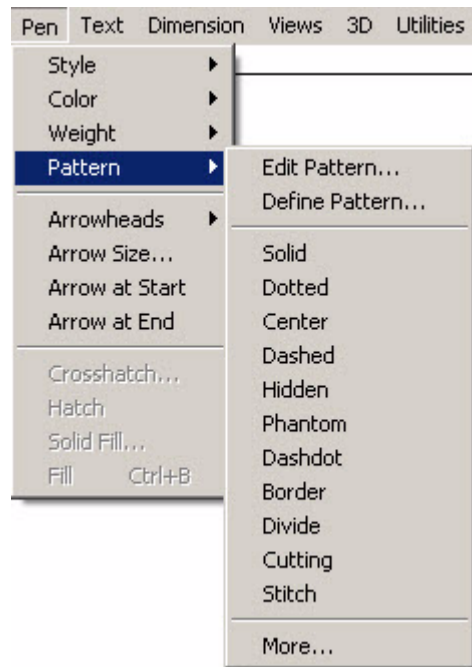

2. Select a pattern.  
The pen takes on the new pattern.

### Setting a User-defined Pattern

1. Choose **Pen>Pattern>More**. The Line fonts dialog box appears.

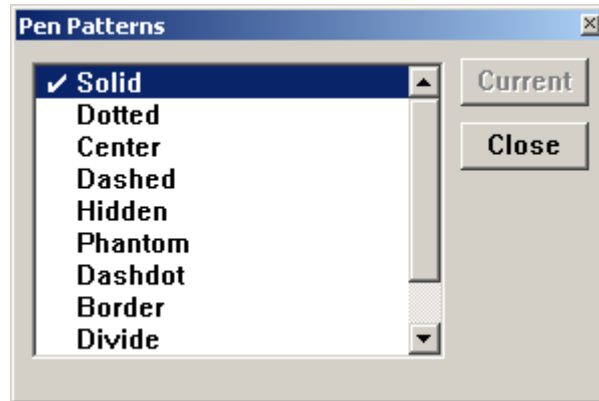

2. Scroll down to the desired pattern and select it.
3. Click Current.  
The pen takes on the new pattern.

### ***Defining and Editing Pen Patterns***

Edit the standard patterns included with Graphite or create up to nineteen patterns of your own.

### ***Define Pattern Command***

This command, found by choosing **Pen>Pattern>Define Pattern**, defines up to nineteen line patterns.

Graphite considers each line segment and each space between line segments separate dashes. Each dash has a handle, represented by a box attached to the vertical line extending from the end of each dash.

One complete element of the line pattern appears in the pattern window. The default visible length is two inches. To create patterns with dashes or elements larger than two inches, change the value in the *Visible Length* data field to an appropriate number. The Pattern Window scales the pattern element accordingly.

Graphite automatically scales line patterns by the inverse of the scale factor set in the Drawing Size dialog box or Sheet Into View dialog box so that the pattern spacing is appropriate for the viewing and drawing scale of the geometry. Set the pattern spacing independently of the viewing or drawing scale, or change the pattern altogether. The Edit Pattern dialog box controls the pattern spacing for nine of Graphite's eleven different line patterns. Solid and dotted patterns cannot be edited.

These patterns are saved as default patterns by choosing **Layout>Preferences>Save Preferences**. To save these patterns with the file only and not as default patterns, just save the file.

### Defining a Pen Pattern

1. Choose **Pen>Pattern>Define Pattern**. The Define patterns dialog box appears.

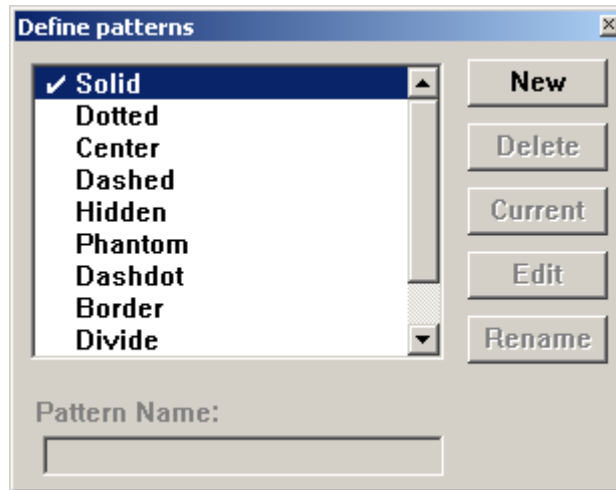

2. Click New.  
The User1 default name is added to the bottom of the patterns window and appears in the Pattern Name field.
3. Click Edit. The Edit Pattern dialog box appears with the default name User1 in the Edit Pattern field.

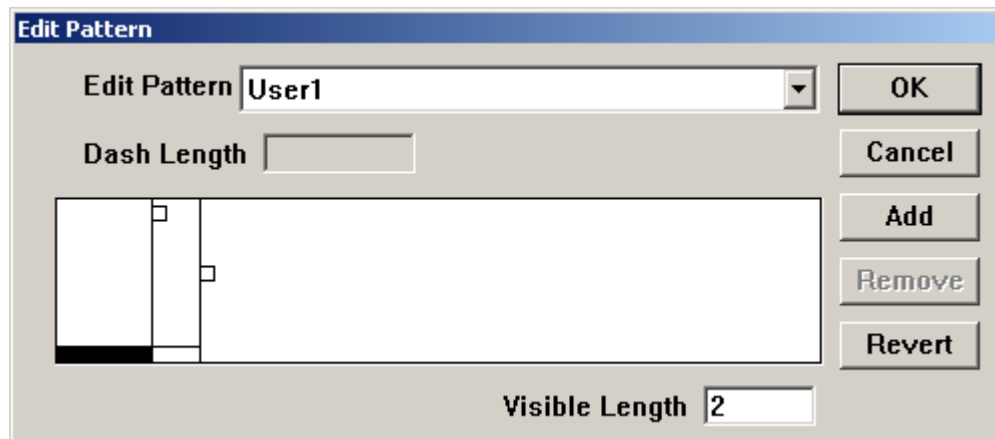

By default there are two dashes, a solid line segment and a blank segment.

4. Create the pattern by modifying the length of these segments and/or adding dashes.

Clicking the dash handle (to the right of the dash) activates the handle for the pattern segment. The dash's current length appears in the Dash Length data field. There are two ways to change the length of a dash:

Enter a new value in the Dash Length data field and change the length of the selected dash.

Drag the handle. While dragging, the dash's length updates in the Dash Length data field. Release the mouse button when the dash is of desired length.

To add a new dash, click Add. A blank, solid dash is added with a length of zero. The solid dash handle is activated. Change the length of the new dashes by dragging their handles or by typing in a value in the Dash Length data field. If a handle is selected before clicking Add, the new dashes are placed in front of the selected dash.

To remove a dash, select its handle and click Remove. The dash is removed from the pattern element.

**Note:** Pattern elements start with solid dashes, and then switch to blank dashes, and then, if necessary, back to solid, and so on. Adding or removing dashes may change existing dashes from solid to blank or from blank to solid.

5. When the pattern element is properly defined, click OK. The new pattern is created and the program returns to the Define patterns dialog box.  
Click Cancel to close the Edit Pattern dialog box without retaining the pattern settings.
6. Select the Pattern Name field and enter a new name for the pattern.
7. Click Rename.
8. Click Current to set the pen to the new pattern.
9. Click the Close button in the title bar to close the dialog box.

### ***Edit Pattern Command***

This command, found by choosing **Pen>Pattern>Edit Pattern**, edits all line patterns but Solid and Dotted.

To edit a pattern already used in geometry within the drawing, the geometry automatically updates to the revised pattern. For example, if the Phantom line pattern is edited, every line in the existing document drawn in the Phantom line pattern changes to reflect the revision.

Edited line patterns also scale by the inverse of the viewing and drawing scales, but editing the pattern controls how the patterns appear on the screen and on paper.

### **Editing a Pen Pattern**

1. Choose **Pen>Pattern>Edit Pattern**.

The Edit Pattern dialog box appears.

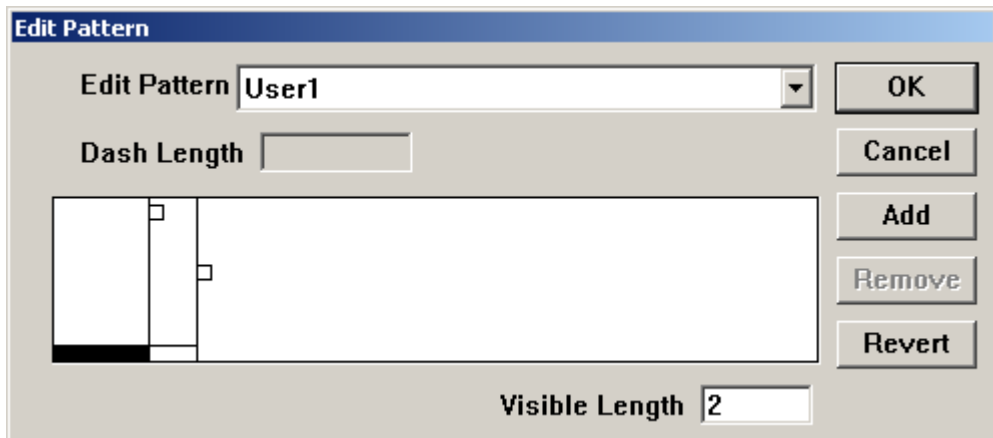

2. Select the line pattern to change from the *Edit Pattern* list.
3. Modify the line pattern by changing the lengths of existing dashes or by adding or removing dashes to or from the element.
4. When the pattern element is properly defined, click OK and the dialog box closes. All existing lines drawn in the edited line pattern change to reflect the new pattern element, as will all future lines drawn in the line pattern.

Click Cancel to ignore all the changes made to any pattern elements and close the Edit Pattern dialog box.

## Undoing a Pattern Edit

Do not undo a pattern edit with the *Undo* command. To return to the standard patterns that came with the program, click **Revert** in the Edit Pattern dialog box. **Revert** changes the line patterns back to their defaults, not just the pattern selected from the Edit Pattern list. A warning message is presented using Revert.

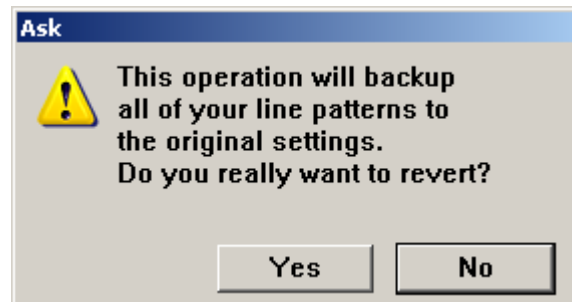

Clicking Yes changes the patterns back to Graphite's original settings. Clicking No returns to the Edit Pattern dialog box without returning changing the current settings.

To undo changes made to user-defined patterns, previously saved as a preference, save the file (if necessary), close and relaunch the program, and then open the file. All user-defined patterns return to their previously defined settings. Edited Patterns affect only the patterns in the current file. To save the edited pattern so that it is available in all future files, choose **Layout>Preferences>Save Preferences**.

## Pen Styles

Pen styles help simplify the design process by defining the color, weight and pattern type for each style. Then rather than having to set each pen characteristic each time a specific type of line is desired, choose one of the predefined styles. Nine pen styles are provided.

The following are the default settings for the styles in the Pen menu:

### Outline



Solid, .01 inch, black lines - the default pen setting.

### Visible



Solid, .02 inch, black lines.

### Hidden



Hidden pattern, .016 inch, red lines. Hidden lines are actually visible on the screen and in the drawing; they represent lines that would be hidden in a solid object.

### Dash



Dashed, .016 inch, yellow lines.

### Center



Center, .01 inch, green lines.

### Phantom



Phantom, .01 inch, cyan lines.

### Dimension



Solid, .002 inch, blue lines. (These lines are .002 inch thick, regardless of the weight you specify.)



**Balloon**

---

Solid, .005 inch, green lines.

**Construction**

-----

Dotted, .002 inch, magenta lines. This does not create construction lines but uses construction line characteristics. True construction lines are placed on the construction layer and are deleted while choosing **Layout>Delete Constructions**.

**Modifying Pen Styles**

Modify a pen style as needed. Change one characteristic of the style by choosing it in the Pen menu or change the style for the duration of the work session by choosing **Pen>Style>Edit Style**.

**Changing One Characteristic of a Pen Style**

1. Choose the pen to modify.
2. In the Pen menu, choose a characteristic: Color, Weight, or Pattern.

To return a standard pen to its original specifications, choose a different pen style from the menu and then choose the modified pen again. Change all of the specifications for a standard pen by redefining it with the *Edit Style* command by choosing **Pen>Style>Edit Style**.

### ***Edit Style Command***

This command from the Style submenu of the Pen menu sets the characteristics for the pen styles.

#### **Redefining the Specification of a Pen Style**

1. Choose ***Pen>Style>Edit Style***.

The dialog box appears.

2. Select the pen style to change by pressing the *Style* data field.

When the list of pen styles appears, choose the style to change.

3. Specify the characteristics (*Color*, *Weight*, and *Pattern*) for that style.
4. Click OK to set the specifications and close the dialog box, or click Apply to put the specifications into effect for a single pen style and leave the dialog box open to make changes to another pen style.

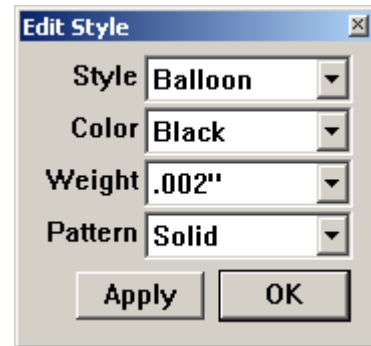

When editing a style, set new specifications for future uses of that pen. The specifications remain in effect for the document in which they are set until changed again with the *Edit Style* command. Change the default setting of any pen style by saving changes in the preferences file. See the “Saving Preferences” section at the end of this chapter.

Although style characteristics can be changed, style names cannot. Keep this in mind changing the pen pattern. Otherwise, the style name may not reflect the pattern and cause confusion if the changes are saved as a preference.

## Setting Units

Graphite is set to measure geometry in inches. When opening a new drawing, set the precision, units, and fractional or decimal specifications as needed.

### Units Command

This command is found by choosing **Layout>Preferences>Units**. A dialog box displays.

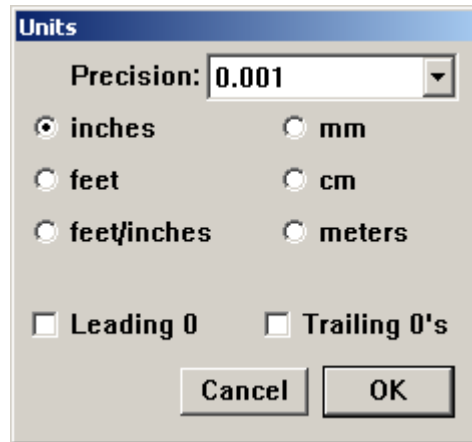

#### Precision

Sets the number of decimal places in all data fields within Graphite (in Edit Objects, the Status Line and all dialog boxes). The default is 0.001.

When choosing a fractional precision, measurements appear as fractions rather than decimals. Set the format for fractions by choosing **Dimension>Linear**.

When Graphite rounds off values it stores the number, accurate to 16 decimal places; therefore, it is possible to change the precision displayed at any time and maintain the desired accuracy.

Altering the decimal or fractional precision does not affect any dimensions. The precision of dimensions is selected by going to the Dimension menu and choosing the setting in the Linear and Angular submenus. A fractional precision is

	required with fractional dimensions. The same is true for decimal dimensions.
<b>Inches, feet</b>	Displays measurements in English units. Measurements less than 1 foot appear in inches and those greater than 1 foot appear in feet and inches.
<b>mm, cm, meters</b>	Displays measurements in metric units.
<b>Leading 0's</b>	Determines whether or not the zero to the left of the decimal point appears.
<b>Trailing 0's</b>	Determines whether or not zeros to the right of the decimal point are displayed. If set, the precision determines the number of trailing zeros.

All geometry reflects the new unit measurement, converting automatically between English and metric. When changing the units, existing dimensions update to reflect the change.

### ***Using the Status Line to Specify the Unit of Measure***

Use the Status Line to specify a unit of measure other than the one in effect for the document. If the units are set to inches for drawing a line, use different units of measure such as inches ("), feet ('), feet and inches (x'y"), millimeters (mm), centimeters (cm) and meters (m). Mix the units in the mathematical expression if they are labeled properly. For example: 10" + 25.4 cm.

In the following example, if the units are set to inches, enter **23'** in the Length data field as shown below.

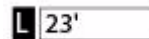
 L 23'

When ENTER (Windows) or RETURN (Macintosh) is pressed, a line 23 feet long is drawn. Graphite converts the length to inches and the Status Line displays the length in inches because of the Units setting.

In addition, it is permissible to use mathematical, exponential, and trigonometric expressions in the Status Line. Appendix A provides examples of the valid operators.

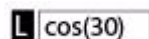
 L cos(30)

## The Grid

When the Grid is visible, objects snap to the grid spacing. To place an object between the grid marks, either turn off the grid, change the grid spacing, or zoom in so that the spacing is larger than the Hit Radius. The grid spacing automatically reflects the units set in the Units dialog box. When the units are changed, the appearance of the grid spacing remains the same, and the values listed in this dialog box change automatically.

### Grid Command

This command, found in **Layout>Preferences**, sets the spacing of the grid lines. Specify the number of ticks (subdivisions) per unit (spacing). Change the default setting by saving changes in the preferences file.

### Show Grid

CTRL+G (Windows);⌘+G (Macintosh)

This command in the Layout menu controls the display of the grid. The grid is made up of horizontal and vertical lines of dots. The spacing of the grid lines and the number of tick marks between the intersections are set in the Grid dialog box by choosing **Layout>Preferences>Grid**. When the grid is visible, the Drafting Assistant snaps to the grid spacing. In other words, if the grid is set to .25 inch spacing, constructing an object cannot be done closer than .25 inch to another object.

The coordinate symbol appears at the origin location (X=0, Y=0) when the grid is visible.

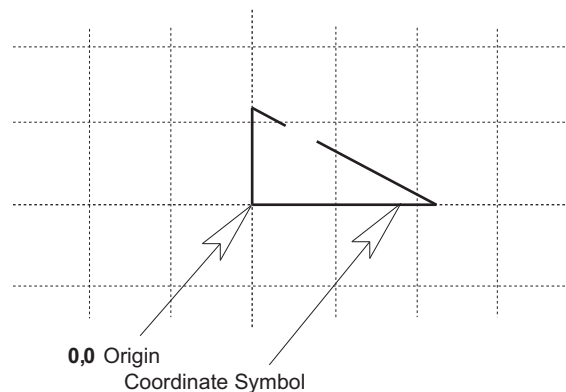

*Tech Note:*

To change the Hit Radius, choose

**Layout>Preferences>Snap.**

### ***Changing the Grid Spacing and Subdivision***

1. Choose ***Layout>Preferences>Grid.***

The Grid dialog box displays.

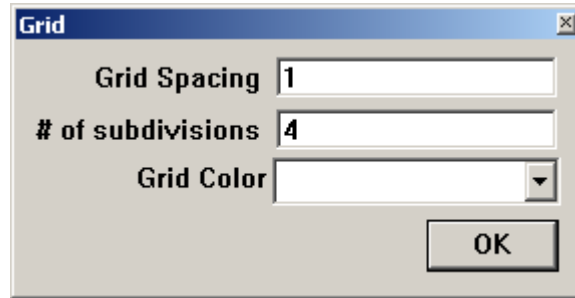

2. Enter the desired values for *Grid Spacing* and/or *# of subdivisions*.
3. Select the grid color from the drop down menu.
4. Click OK and the changes are saved.  
Click Cancel to prevent saving the changes.

## ***Drawing at Full Scale***

Whether designing or drafting a highly detailed blueprint, create the geometry at its actual size. In Graphite it is possible to construct the part using full-scale specifications and then set the visual scale of the drawing. In this way, the part dimensions to its true-to-life measurements. Drawing at full scale has the following advantages:

- Scaling mistakes are eliminated.
- Dimensions are automatic (dimension manually if drawing is not at full scale).
- Associative dimensions update when the object is edited (manual dimensions do not).
- The size relationship of imported parts is compatible.
- Calculations for 2D analysis are accurate.

Once the project is drawn, dimension it, scale it visually and size it to fit into a standard drawing format, if necessary. The actual size of the geometry remains constant unless edited.

When opening a new Graphite document, the drawing area is a sheet that is infinitely large so that anything can be designed at full size. For a simplistic example, here's how to draw and view a line 83 feet long:

1. Draw a line, specifying **83'** for the length.

The line extends off the screen.

2. Choose **Arrange>Zoom All**.

The entire 83 foot line is visible on the screen.

Using the draw to scale/Zoom All method, create accurate full-scale drawings which are displayed at the magnification chosen. The actual size of an object is not affected by zoom magnification or reduction.

*Zoom All* magnifies or reduces all objects on the drawing to fill the screen regardless of the size of the objects.





### Drafting without a Drawing Format

1. Start Graphite and display an Untitled document.
2. If necessary, set the Units of measure to use by choosing **Layout>Preferences>Units**.
3. Construct the geometry at full size, saving the construction while working. Use the Zoom commands and tools to display the part at an appropriate magnification in order to see what is done.
4. Choose **File>Print Setup** (Windows) or **Page Setup** (Macintosh) command to set the paper size for plotting or printing.
5. Choose **Layout>Drawing Size** to set the drafting scale for plotting or printing. Specify the drafting scale for the drawing, such as *1:120* or *1":10'* for 1 inch to represent 10 feet. If the scale is not of concern and the final geometry only needs to fit on the selected paper size, specify Fit to adjust the geometry automatically to the paper size.
6. Dimension the part and add text.  
When specifying the visual scale for the drawing with the *Drawing Size* command, Graphite scales text, dimensions, hatches and line patterns inversely with the same scale factor so that all text and dimensions added after scaling have exactly the size specified in the **Size** submenu in the Text menu. That means if the text size is set for text and dimensions to 0.25 inches it plots at a size of 0.25 inches on the paper.
7. Make final adjustments.
8. Choose **File>Print**.

### Drafting with a Drawing Format

1. Start Graphite and display an Untitled document.
2. If necessary, set the Units of measure by choosing **Layout>Preferences>Units**.
3. Construct the geometry at full size, saving the construction in the process. Use the Zoom commands and tools to display the part at an appropriate magnification in order to see what is done.
4. Use the *Sheet Into View* command from the Views menu to set the visual scale so that the part fits into the size of the drawing format selected in the pop-up menu in the Sheet Into View dialog box.
5. Dimension the part and add text.

When you specify the visual scale for the drawing with the *Sheet Into View* command, Graphite scales text, dimensions, hatches and line patterns inversely with the same scale factor so that all text and dimensions added after scaling have exactly the size specified in the Size submenu of the Text menu. That means, if the text size is set for text and dimensions to 0.25 inches, it plots at a size of 0.25 inches on the paper.

6. Make any final adjustments.
7. Choose **File>Print** to print or plot the drawing.

#### *Tech Note:*

If text and dimensions are added before scaling the drawing with the *Drawing Size* command, all text and dimensions must be selected with the *Selection Mask* to set the text size again to the desired value, for plotting on the paper. See Scaling Text and Dimensions in Graphite Documents.

# OS Settings

## Windows Settings

### *Graphite.ini*

The *Graphite.ini* file is an ASCII text file that can be opened and edited in any text editor, including *NotePad*. This file contains setting for the number of fonts that appear in the Font submenu, the size of the screen when Graphite is launched, and the number of files that appear in the *Recent File List*.

To make changes to the *Graphite.ini* file, open it in any text editor and make the desired edits. Save the file as a text file. The next time Graphite is launched, it will account for the new setting in the *Graphite.ini* file.

### *MaxFont*

This option sets the number of fonts that appear in the **Font** submenu from the Text and Dimension menus. Graphite takes the fonts in alphabetical order, up to the number that is specified in the *Graphite.ini* file. Fonts that do not show up in the menu are accessed by choosing **Text>Font>Other**. By default this value is left blank, so Graphite displays all the fonts.

### *Screen*

This option sets the size of the screen when Graphite opens. There are two options. *Screen=FULL* opens to a maximized window. *Screen=Standard* opens to the standard size, which is almost maximized but with room for icons at the bottom. If no value is specified, the screen opens to the standard size.

### *Recent File List*

This option determines the number of files that appear in the *Recent File List* from the **File** menu. Specify the number of files that are to appear in the File menu after *Files=*. The names and paths of recently opened files are saved in the list that follows the *Files=* line. *File1=* is always the most recent file opened. As new files are opened, the file list gets shifted down, so the old *File1* becomes *File2*, and so on. The default number of files is four. The maximum number is eight.

#### *Referral:*

For more information about using the *Recent File List*, consult the discussion of the *Recent File List* in Graphite Documents.

## Macintosh Settings

### Fonts

All of your system fonts are available when choosing **Text>Fonts**.

### Recent File List

Specify the number of files that should appear in the *Recent File List* of the File menu. A file named *recent.lst* can be found in the Scripts folder. This file is an ASCII text file that can be opened and edited in any text editor. The following is a sample of the contents of the *recent.lst* file:

```
/aRecentFiles
4      % Number of recent files remembered (8 maximum)
store
/aRecentFileList [
(MacHD:Graphite 3D 3.0:Samples 3D:YF-22)
(MacHD:Graphite 3D 3.0:Samples 3D:Chair 3D)
(MacHD:Graphite 3D 3.0:Samples 3D:Question Mark)
()
] store
```

Before *% Number of recent files* enter a number to specify the number of files that are to appear in the File menu. The names and paths of recently opened files are saved in the list that follows the */aRecentFileList [* line. The first file in the list—YF-22 in the example above—is always the most recent file opened. As new files are opened, the file list gets shifted down. The default number of files is four. The maximum number is eight.

## Saving Preferences

All files save with the settings set for the file. The characteristics used for new files (the default settings) appear in the preferences file.

### Preferences Command

This command in the Layout menu displays a submenu for setting various specifications. Descriptions of the items in the submenu appear individually in this reference section. Change the default setting by saving changes in the preferences file, *prefs.vc6* (Windows) or *Graphite prefs* (Macintosh).

---

<b>Snap</b>	This box sets the alignment angles, hit radius and other Drafting Assistant settings. This is different from the <i>Snap</i> command explained in Chapter 4.
<b>Grid</b>	This dialog box specifies the spacing of the grid lines. Choose <b>Layout&gt;Show/Hide Grid</b> to turn the display of the grid on and off.
<b>Units</b>	This dialog box specifies the units and precision for the current Graphite document.
<b>Selection</b>	Use this dialog box to set the color or blinking which shows that an object is selected.
<b>Undos</b>	Sets the number of last actions to reverse.
<b>Nudge</b>	Specifies the distance selected geometry can be nudged within Graphite using the arrow keys on the keyboard.
<b>Invert</b>	This option inverts the screen from white to black.
<b>DAssistant</b>	This is a toggle switch for turning the Drafting Assistant on or off. A check mark in front marks the <i>on</i> status.
<b>AutoSave</b>	Sets the time interval for the program to save files (if they were modified).
<b>Directory</b>	Specifies the file location for symbols and for opening, saving, importing, exporting files.
<b>Language</b>	Sets the language of the interface.
<b>Icon Style</b>	Sets the icon style for the user interface.
<b>Dimensions Palette Orientation</b>	Sets the orientation of the Dimension palette.

**Save Preferences**

If the desired characteristics such as units, pen style and dimension format are set, it is possible to make those settings the default settings.

Choose **Layout>Preferences>**

**Save Preferences.** Geometry cannot be saved this way. To save the geometry, open the preferences file, create the geometry and save the file.

**Save Palettes**

This saves the status (visible/hidden) and the location of the Dimension, Symbol and Function palettes.

***Saving Preferences Information and Characteristics***

The preferences filename is *prefs.vc6* (Windows) or *Graphite prefs* (Macintosh).

To use different settings for your work, change the default settings, and then every new document opens with the settings selected. The following specifications are set in the preferences file:

- Pen styles
- Text characteristics
- Preferences settings (snap, grid, units, selection color indicator, and visualization settings)
- Grid display
- Layer and sheet specifications
- Work layer
- Dimension and tolerance formats
- Arrowhead type and display
- Drawing size and scale
- Zoom scale
- Fillet radius
- Chamfer angle and length
- Resolve values
- User defined colors

### Changing the Default Settings

1. Create a file which has the desired preferences.
2. Choose **Layout>Preferences>Save Preferences**.

The preferences are set for subsequent new documents after restarting Graphite.

Be careful choosing *Save Preferences* when working in a file with multiple sheets, models, details views, or layers. Even though the geometry is not saved, all other data is. All new files opened subsequently will contain items that are not desired. Check the Preferences file for the items mentioned on a regular basis. The original default setting for the file includes one sheet, one model, three layers (Construction, Dimension, and Layer 1) and no detail views.

## Save Palettes

In the Preferences submenu find the *Save Palettes* command. When selecting this command the Status (visible/hidden) and the Location of all palettes are saved to preferences. When restarting Graphite, all palettes that were displayed while closing Graphite are automatically reopened.

Location and Status for the following palettes are saved with this command:

- Dimension palette
- Symbol palette
- Function palette
- Tool palettes
- Tear-off palettes

The Trackball does not save with this command.

For Windows, the Location and Status of these palettes are saved in the *Graphite.ini* file, under the section *Palettes*.





# Advanced Environment Settings

This chapter describes the various advanced options that for adapting Graphite to your needs. The following topics are covered:

- Add Command
- Macros
- File Organization
- 3D Viewing

## Add Command

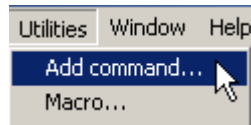

This utility adds custom functionality to the Graphite Utilities menu. Utility scripts are available in the Support Center of the Ashlar-Vellum website, can be developed by you in Ashlar-Vellum's FE language (similar to Postscript), or may be custom developed for you by the Ashlar-Vellum technical team. From the Utilities menu, choose Add Command and navigate to the location on your system where the script is saved. Select the file and click the Open button to place the script in the correct folder. An alert message notifies you that the new functionality will be available after restarting the software.

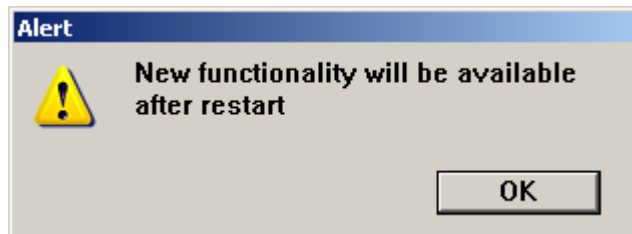

## Macros

It is possible to create macros within Graphite and access them through menu commands, stroke commands, or key combinations, providing an alternative way to invoke these commands.

A macro automates a repetitive task by executing a group of simple commands. Define a macro by pointing and clicking.

### Macro Command

Choose **Utilities>Macro**, and the following dialog box displays:

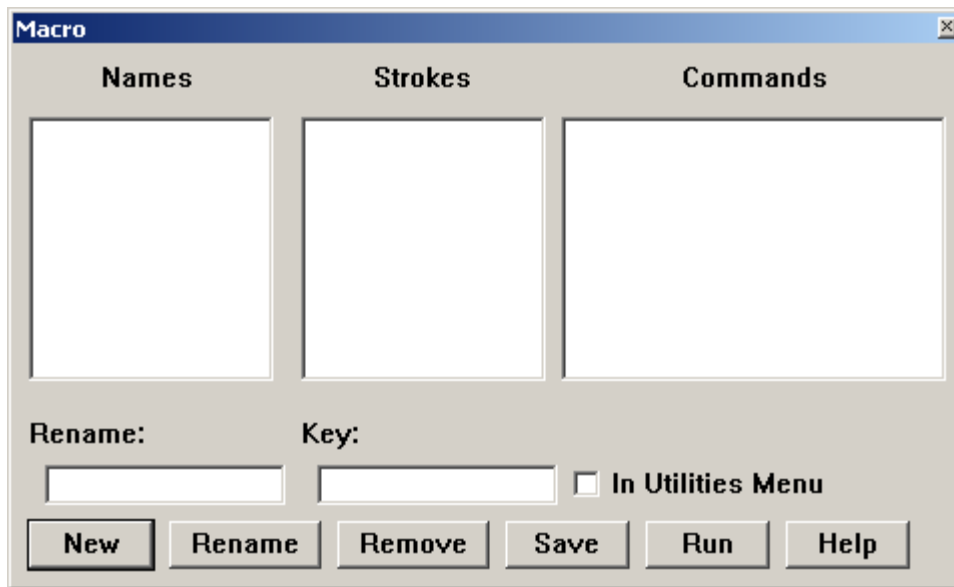

The Macro dialog box is modeless in the sense that there are no *Start Recording* or *Stop Recording* buttons. Whatever actions are performed (selecting menu items or defining strokes) are recorded automatically in the related list boxes as long as the Macro dialog box is open.

The Macro dialog box contains the following buttons:

**New** This adds a macro named *Macro1* to the *Names* list box. Rename the macro in the Rename data field by overwriting **Macro1** with a new name and then clicking the **Rename** button.

---

<b>Rename</b>	This overwrites the selected macro name in the <i>Names</i> list box with the name entered in the Rename data field. (For Windows, macro names may only contain alpha-numeric characters. No spaces or other characters are allowed.)
<b>Remove</b>	Click this to remove any selected entry from one of the three list boxes.
<b>Save</b>	The Save button writes all currently defined macros to files in the Scripts folder in the Graphite installation folder. The file names are generated directly from the macro names. The files are output in such a way that when Graphite is subsequently started, the macros activate automatically. Macro files can be moved to other locations, or to other machines for use in other licenses of Graphite.
<b>Run</b>	The Run button exe the macro currently selected in the <i>Names</i> list box. Macros can call other macros if they are in the Utilities menu. This is done by clicking on the relevant entry in the Utilities menu, like any other menu item. If a macro calls another macro, which in turn calls the original macro an infinite loop is created. These infinite loops are checked when an attempt is made to include a macro, and if detected, an alert box is posted resulting in the macro not being included.
<b>Help</b>	Opens the text file with the instructions on using the macros.
<b>Names list box</b>	The names of all defined macros are alphabetically displayed in the names list box. When one of the items is selected, the <i>Strokes</i> and the <i>Commands</i> list boxes, as well as the <i>Key</i> and <i>In Utilities Menu</i> fields are automatically filled in with the relevant data that defines the selected macro.
<b>Strokes list box</b>	This box shows a group of stroke commands, if any, that can run the selected macro. The names

---

in this list box relate to the encoding of the shape of the stroke and you need not be concerned about them. It is optional to associate a stroke with a defined macro.

**Commands list box**

The *Commands* list box shows the set of menu commands that define this macro. They are shown in this form: *MenuName; EntryName*

**Key**

This assigns the key combinations for a macro by clicking in the *Key* edit box and entering the key combination or typing it directly in the *Key* entry field. For example, enter CTRL+SHIFT (by pressing the CTRL key first, keeping it depressed and pressing the SHIFT key) and then the key **P**. The *Key* edit box displays CTRL+SHIFT P.

Windows users: While creating a macro, if the CTRL key combination designated is already in use, the macro cannot be executed. Macintosh users: While creating a macro, if the designated ⌘ key combination is already in use, Graphite prompts for a different key combination to be assigned.

**In Utilities**

If this is checked, the macro name is included as a menu item in the Utilities menu to access the macro directly.

**Creating a Macro**

1. Choose **Utilities>Macro**. The Macro dialog box displays.
2. Click New.  
The name *Macro1* displays in the *Rename* field.
3. Overwrite the name if desired. (Use alpha-numeric characters with no spaces.)
4. Select menu commands in the order the new macros will execute.  
The selected commands are automatically filled in the *Commands* list box.  
If a stroke command is not desired for the macro, go to step 6.

5. Define a *Stroke* command on the drawing area.  
Press CTRL+SHIFT (Windows) or the ⌘ key (Macintosh) and drag a symbol on the drawing area to be associated with the new macro.  
Use letters or a figure like a circle. Do not use Graphite's standard stroke commands like *Zoom* or *Construction* strokes, since they are executed immediately. A letter and number combination describing the executed stroke displays in the *Stroke* list box automatically. When defining a stroke, repeat it several times to define all variations of the stroke, so that all possible variations are covered and can be recognized by Graphite.
6. Check the *In Utilities Menu* option to include the new macro in the Utilities menu.
7. Enter a Key short cut in the *Key* entry field.  
Click in the *Key* data field and enter the key combination or type it directly in the *Key* data field.
8. Close the Macro dialog box by double-clicking the Control menu (Windows) or the Close button (Macintosh) in the upper left corner of the dialog box.

### ***Editing a Macro***

1. Display the Macro dialog box.
2. Select a macro in the *Names* list box.
3. Rename the macro in the *Rename* data field and click the **Rename** button.
4. Redefine the macro by executing menu items and assigning a new stroke equivalent to the macro.
5. Alter the Macro key combination in the *Key* data field.
6. Close the Macro dialog box by double-clicking the Control menu (Windows) or the Close box (Macintosh) in the upper left corner of the dialog box.

### ***Removing a Macro***

1. Display the Macro dialog box.
2. Select a macro in the *Names* list box.
3. Click Remove.

### ***Running a Macro***

Each macro has a unique name and is run in one of four ways:

- Invoked with a key combination. Subsequent typing of that key combination causes the associated macro to run.
- Invoked by a family of stroke commands defined in the Macro dialog box.
- Selected the Utilities menu if the *In Utilities Menu* option was checked in the Macro dialog box.
- Executed by selecting it from the *Names* list in the Macro dialog box and clicking Run.

Executing a macro with the Run button is useful for testing a macro. Should it not work properly, highlight any dialog box entry and remove it by pressing the Remove button. Modify the macro as needed then test it again by pressing the Run button. Continue this process until the macro runs properly.

### ***Macro Limitations***

Macros are not general programs. There are limitations as to what is encoded in a macro. The following rules apply:

- Only menu items and tools are included in a macro.
- A menu item might cause a dialog box to appear, but the macro cannot fill in the required entries.
- There are no conditionals (like *if* or *ifelse*) or loops (like *while*).
- Subroutines are allowed so that one macro can call another macro, provided the called macro is in the Utilities menu and therefore a menu item. If a macro calls a nested macro which ends in an infinite loop, an alert box appears and the macro aborts.
- Macro names are limited to alpha-numeric characters with no spaces.

## File Organization

Graphite enables you to organize your files. The *Directory* command in Preferences specifies the file location for symbols and for opening, saving, importing, exporting files. See Chapter 15 for more information.

## 3D Viewing

Although the transition between 2D and 3D drawing in Graphite is seamless, there are a few settings and features that are unique to 3D. When opening a new document an empty work area displays. This work area, a sheet, is an infinitely large drawing space for creating a model of any size. The new sheet displays the Top view by default on the x, y plane of the model space picked up by the sheet camera. When constructing geometry in 3D, rotate the sheet camera to a 3D view.

It is also possible to start drafting in 2D and then continue drafting in 3D simply by changing the view.

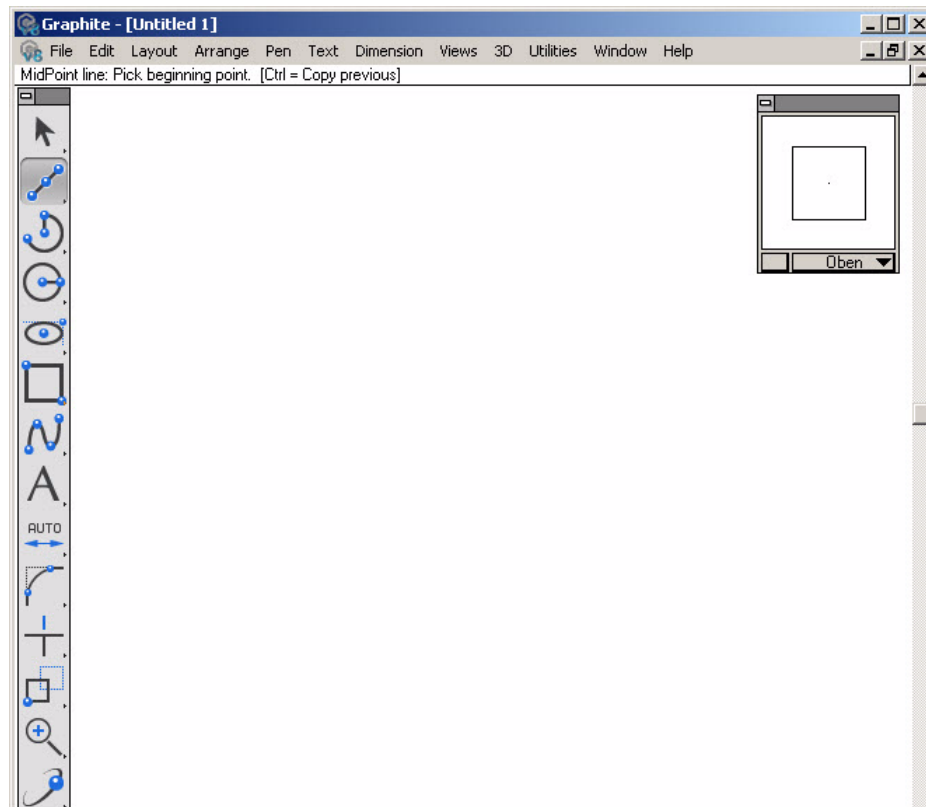



Once the sheet camera is rotated, it is as though the model rotates so that all the x-, y-, and z-directions can be seen while drawing.

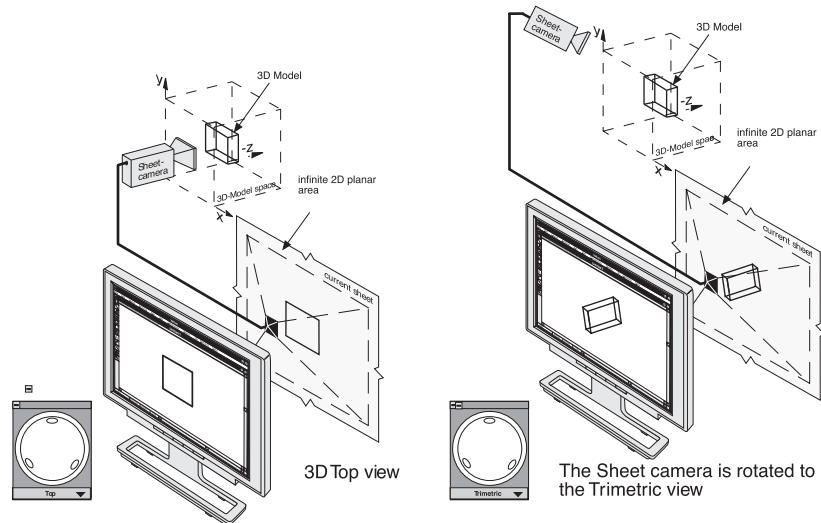

There are several options for this rotation:

- Manually rotate with the on-screen Trackball.
- Select a view from the pop-up menu in the Trackball window.
- Choose a view from the Views submenu in the Views menu.

## Show/Hide Trackball/Trackcube

This command toggles the display of the Trackball/Trackcube window. Use the Trackball/Trackcube to rotate the view orientation in the active detail view window or the sheet view, as long as no view windows have been created. Drag the Trackball window around the screen. For more information on detail views and sheet views, see Chapter 13, "Viewing Geometry." To rotate between the Trackball and the Trackcube, click on the box in the lower left corner.

### Tip:

The Trackball can be changed to the Trackcube by clicking the button in the lower left corner of the Trackball window.

### Rotating the Sheet View or Active View

1. Choose **Views>Show Trackball**.
2. Drag the pointer on the Trackball to rotate the view.  
The model rotates as you drag. The model rotates around the center of the active view or sheet.

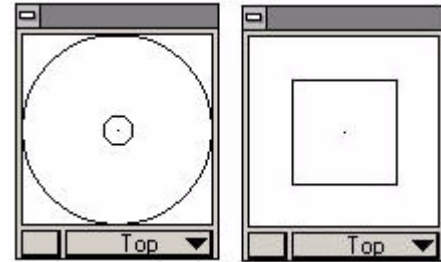

### Using the Trackball View Menu

The Trackball/Trackcube has a pull-down menu for specifying the view of the current view window or the sheet view, if there are no view windows.

1. Move the pointer to the current view name displayed at the bottom of the Trackball/Trackcube window.
2. Press the mouse button. The Views menu displays.
3. Choose the view orientation to display in the current window.

The view orientation changes to the specification in the view window.

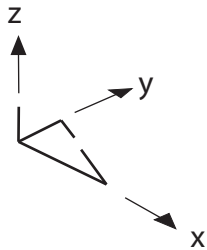
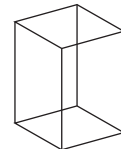
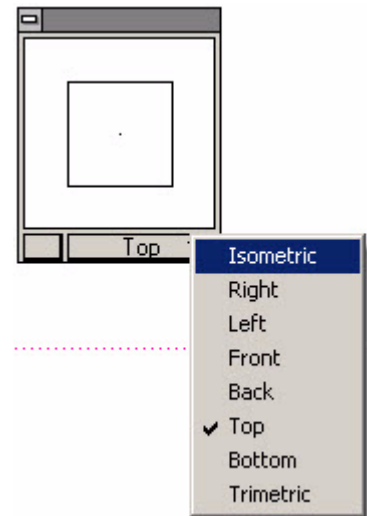

#### Tip:

To see the Triad at the origin (0,0,0), set the grid spacing to 0 in the Preferences submenu in the Layout menu.

### Trackball Locking

This feature locks the Trackball/Trackcube along two screen axes so that the view of the geometry is rotated around the third screen axis. The screen axes are different from the axes of the geometry unless the top view is set.

#### Example:

It is possible to rotate the view of this block around the x-,y- or z-axes of the geometry or the screen.

### ***Rotate View around an Axis of the Geometry***

To rotate the view around an axis of the geometry, change the view to Top, either from the Trackball menu or choosing **Views>Views>Top**. This makes the screen axes the same as the axes of the block.

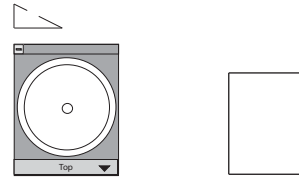

### ***Rotate View around the X-axis***

To rotate around the x-axis, place the cursor on the Trackball, hold down the SHIFT key and drag the cursor up or down. The geometry rotates around the x-axis.

Holding down the SHIFT key locks both the y- and z-axes.

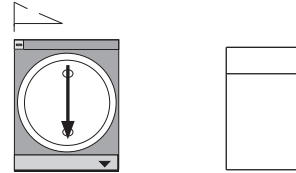

### ***Rotate View around the Y-axis***

To rotate around the y-axis, place the cursor on the Trackball, hold down the CTRL key (Windows) or the OPTION key (Macintosh) and drag the cursor to the left or right. The geometry rotates around the y-axis.

Holding down the CTRL key (Windows) or the OPTION key (Macintosh) locks both the x- and z-axes.

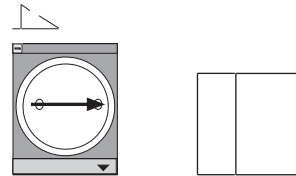

### ***Rotate View around the Z-axis***

To rotate around the z-axis, place the cursor on the Trackball, hold down the CTRL+SHIFT keys (Windows) or the ⌘ key (Macintosh) and drag the cursor in a circular motion. The geometry rotates around the z-axis.

Holding down the CTRL+SHIFT keys (Windows) or the ⌘ key (Macintosh) locks both the x- and y-axes.

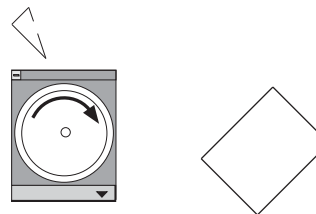

### ***Rotate View around the Screen Axis***

With the same block displayed in any view, simply use the key combinations listed previously to rotate around the desired axis.

If the geometry is displayed in the trimetric view and it needs to be rotated around the screen's z-axis, place the cursor on the Trackball, hold down the CTRL+SHIFT keys (Windows) or the ⌘ key (Macintosh) and drag the cursor in a circular motion. The geometry rotates around the screen's z-axis.

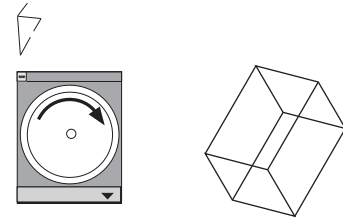

### **Show/Hide Triad**

This command toggles the display of the Triad symbol in the upper-left corner of the view windows. The Triad illustrates the orientation of the x, y, z axis and the work plane. This symbol also temporarily displays at the origin and rotates as the view orientation is rotated manually with the Trackball.

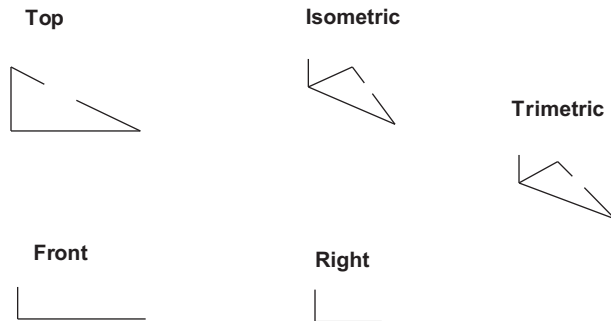

If a detail view is not created, the Triad symbol displays in the upper-left corner of the sheet. Once a view window is created, the sheet camera cannot be rotated any more. It remains stationary at the world orientation. For more information on detail views and sheet views, see Chapter 13.

The Triad represents the principle of the right-hand rule—a memory aid for the relative directions of the positive axes. With your right palm upturned, the thumb (x) points right, the index finger (y) points straight ahead, and the middle finger (z) points up. If you move your hand to indicate the x and y-axes, you can easily see the direction of the z-axis.

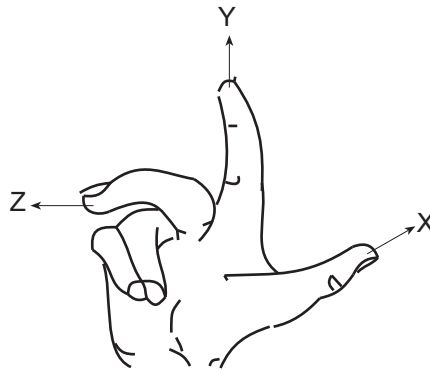

The Right Hand Rule

## Views Command

This command displays the view orientation submenu to set the orientation of the sheet view or active view window.

The standard views, Front, Isometric, Right, Top and Trimetric, are always displayed in this menu. Create new views with the *Define View* command and those views are listed in this menu. Views are also selected from the Trackball menu. (See Chapter 14 for more information on *Define View*.)

The selected view orientation affects the active area, including the sheet view or the active view window.

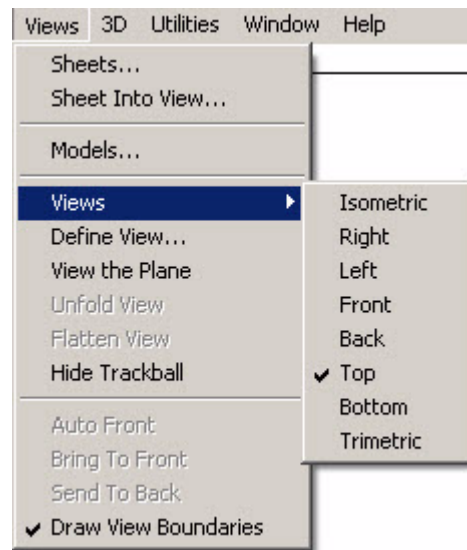



# Drawing Tools

This chapter describes how to create geometric objects that are the building blocks for the designs created with Graphite's drawing tools. It also describes how the Drafting Assistant makes design faster and easier. The following topics are contained in this chapter:

- Drawing Techniques
- The Status Line
- The Message Line
- Drawing Tools - Description and Use

Drawing begins with the tool palette, located at the left of the Ashlar-Vellum Graphite drawing area shown below:

The tool palette has seven subpalettes of tools used to create and select geometric objects. These seven tools are the drawing tools.

*Referral:*

For more information about the Drafting Assistant, see Chapter 4.

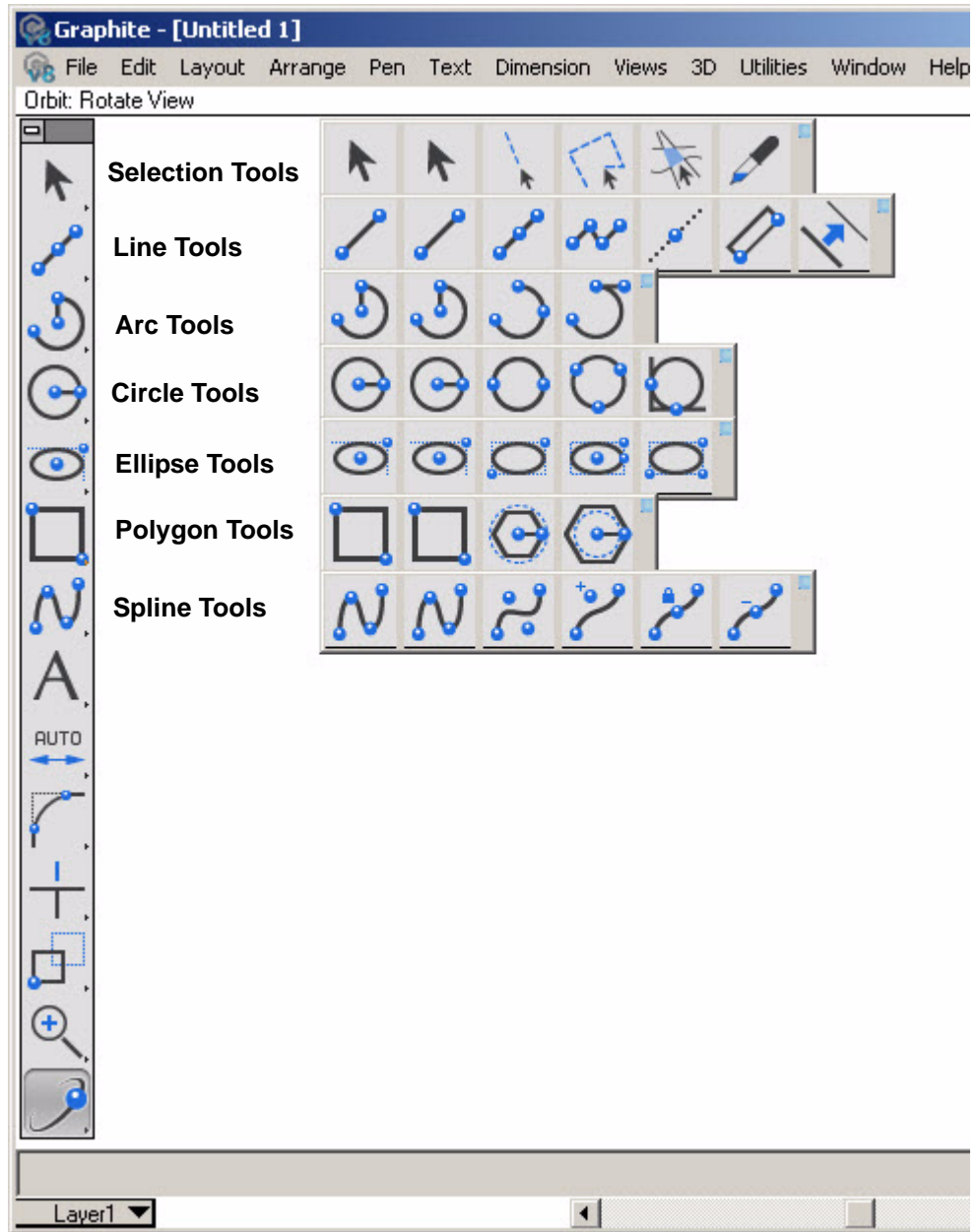



## *Drawing Techniques*

Most drawing tools offer two methods for creating an object: clicking and dragging.

### **Clicking**

This creates objects by clicking points with the mouse. The benefit of this technique is in performing unrelated activities, such as zooming, while creating the geometry.

### **Dragging**

This method indicates two points by dragging from one to the other. Press and hold mouse button to set the first point. Next, drag the mouse to the location for the next point and release the mouse button. The benefit of this technique is that a rubberband image appears during the construction to show how the object will appear once the mouse is released.

Both methods are available in most tools.

To make object creation easier, Graphite's tools contain a feature called Smart Pointers. While working with a tool, the tool icon shows the points that must be indicated to create an object with the tool.



Each dot on the icon, such as the **Single Line** tool icon shown here, represents a point to place either by clicking or by dragging. The smart pointer indicates the order for designating points while drawing the geometry.

## Creating a Line by Clicking

1. Select the **Single Line** tool from the tool palette.



2. Move the pointer to the drawing area and click to set the starting point of the line.
3. Move the pointer to the desired location for the endpoint of the line and click.

### *Tech Note:*

Notice that there is no rubberband guide line when using the clicking method.



x Click at the beginning point of the line

x Click at the endpoint of the line

The line is drawn between the two points.



Immediately after construction, changes can be made in the Status Line at the bottom of the drawing area to alter the length or position of the line. If the geometry isn't satisfactory, just press the BACKSPACE (Windows) or the DELETE (Macintosh) key.

## Creating a Line by Dragging

1. Click the **Single Line** tool in the tool palette.



2. Move the pointer into the drawing area.
3. Press and hold the mouse at the desired location for the starting point of the line.
4. With the mouse button still held, move the mouse to the desired location for the endpoint of the line.



x Press and hold the mouse button at the starting point of the line.

x Drag the mouse until the line is the desired length. Release the mouse button.

5. Release the mouse button to set the endpoint.

Immediately after construction, changes can be made in the Status Line at the bottom of the drawing area to alter the length or position of the line. If the geometry is not satisfactory, just press the BACKSPACE (Windows) or the DELETE (Macintosh) key.

### *Tip:*

Notice that when dragging between points, a rubberband line acts as a guide. When using the clicking method, unrelated activities, such as zooming can be performed between clicks.

## The Status Line

Whenever a tool from the tool palette is selected, the Status Line appears along the bottom of the drawing area. It contains fields that provide information about the current construction. For example, when the **Single Line** tool or **Connected Lines** tool is the current tool, the Status Line contains fields for the X and Y coordinates of the beginning point and the change of X and Y values for the endpoint of the line. It also contains the value of the length and angle of the line.

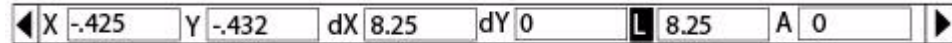

Use the Status Line in three ways:

- To create an object with keyboard entries only.
- To edit an object that was just created and is still selected.
- To create an additional object using the current tool.

When constructing an object, the status field contains selected specifications that can be changed (the field is highlighted). For example, when drawing a line with the **Single Line** tool, the Length data field is highlighted to enter a value for the length. Just type a value. Press ENTER (Windows) or RETURN (Macintosh) and the line is redrawn at the new length.

Set the number of decimal places for the Status data field entries or fractional round off by going to **Layout>Preferences>Units**. In the Units dialog box set the precision.

### Using the Status Line Fields

To make an entry in a different status field, use one of four selection methods:

- Press the Tab key to cycle the selection highlight through the status fields from left to right.
- Click inside the status field and the pointer becomes an *I-beam* text cursor.
- Double-click inside the status field to select the entire contents of the field.
- Click the field label to select the entire contents of the field.

#### Tip:

Notice how each method affects the selection of the contents of the status field. Clicking once inside the field places the cursor where clicked. If double-clicking inside the field, the entire entry is selected for editing.

## Using the Status Line with Drawing Tools

After an object is drawn, specifications, such as the length, angle and location can be adjusted in the Status Line. It is possible to make these changes immediately, before constructing another object, selecting a different tool, or choosing another command.

Make only one series of changes in the Status Line (in as many fields as necessary). After pressing ENTER (Windows) or RETURN (Macintosh) Graphite redraws the object to the specifications. Once ENTER (Windows) or RETURN (Macintosh) is pressed, make subsequent changes with the *Edit Objects* command in the Edit menu.

**Note:** When working in English units, values in the Status Line can be entered as a combination of feet and inches. Enter them as **x'y"** and not **x'-y"**. The dash reads as a minus sign and **x'-y"** is calculated as an equation. See Appendix A for operators and units.

Try the following exercises to create and change a single line with the Status Line.

### ***Altering Geometry in Progress with Status Fields***

1. Select the **Single Line** tool.
2. Click two locations in the drawing area. The length (**L**) field automatically highlights in the Status Line.
3. Type **3**. The 3 is entered directly in the L field.
4. Press the Tab key to select the next status field. The angle (**A**) field now highlights.
5. Enter **15**.
6. Press ENTER (Windows) or RETURN (Macintosh).

Pressing ENTER (Windows) or RETURN (Macintosh) completes the data entry for this object. The line redraws 3 units long and at a 15° angle.

Remember that by pressing ENTER (Windows) or RETURN (Macintosh), Graphite constructs the object based on the specifications in the status fields. Pressing ENTER (Windows) or RETURN (Macintosh) a second time in the above example creates a second line with the same values. Since the lines have the same values, the second line overlays the first line, obscuring it from view.

***Creating Additional Geometry with Status Fields***

1. With the **Single Line** tool still selected from the previous example, click two more points.
2. Type **4**.
3. Press the Tab key and type **25**.
4. Press ENTER (Windows) or RETURN (Macintosh). Another line is drawn.

***Creating New Geometry with Status Fields***

1. Choose the **Selection** tool so the Single Line status field clears.
2. Click the **Single Line** tool again.  
With the X status field is active, enter a value for the X coordinate of the beginning point of the line.
3. Type **0**.  
**Note:** Do not press ENTER (Windows) or RETURN (Macintosh) until step #10.
4. Press the Tab key. The Y field highlights.
5. Type **0**.
6. Press the Tab key again.  
The dX field highlights. The dX value is the delta X, the numeric difference between the beginning and ending X coordinate.
7. Type **2**.
8. Press the Tab key. The dY field highlights.
9. Type **2**.
10. Press ENTER (Windows) or RETURN (Macintosh). The line is drawn.

### ***Creating Geometry Offset from a Point***

To create geometry that is offset from an existing point, use the Status Line to specify the offset.

1. Select the tool.
2. Move the pointer over the control point from which you want the offset.
3. Click once to lock onto that point.
4. Click in the appropriate X or Y field in the Status Line, placing the text cursor at the end of the entry.
5. Type the offset (such as **+ 3"**) and press ENTER (Windows) or RETURN (Macintosh).
6. Continue the construction.

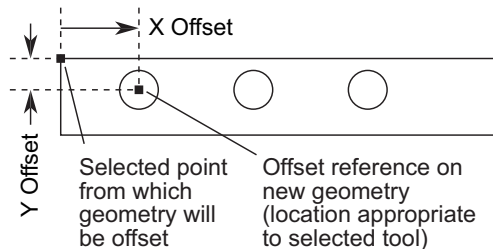

## ***The Message Line***

The Message Line is an important feature when drawing. Upon selection of a drawing tool, the line displays the tool selected and the first step in its use. Following each step, the line displays the next one until the steps are completed. The Message Line may also display additional commands to use with the tool. See the example below.

Center-Point Circle: Pick center. [Ctrl = Copy previous]



## Drawing Tools - Description and Use

This section describes the drawing tools found in the tool palette. For a description of the selection tools see Chapter 9.

### Line Tools



The Line tools in the **Line** tool palette create line segments, connected lines, lines parallel to existing lines and smart walls. While creating a line, the coordinate locations, line length and angle from horizontal appear in the Status Line. Dragging creates a rubberband smart wall, so that it is seen before it is drawn. The line is also drawn with the current pen specifications for color, weight and pattern.

### Single Line Tool



This tool, in the second subpalette of the main tool palette, draws a line between two points. Click or drag to draw a line.

#### Using the Single Line Tool

1. Select the tool. The Message Line reads, *Single Line: Pick the beginning point.* [Ctrl = Copy previous (Windows) or Option = Copy previous (Macintosh)].
2. Click two endpoints of the line,  
or

Drag to indicate the endpoints of the line; press at the beginning and release at the end of the line. While dragging, a rubberband line previews the construction.

To copy the line just created, as the Message Line indicates, hold down the CTRL (Windows) or OPTION (Macintosh) key and click once in the drawing area. A line appears that is identical to the one just drawn. The location of the click designates the location of the first endpoint.

The Status Line specifies the X,Y coordinates of the beginning, the relative location of the end (delta X and delta Y), the line length, and the angle from horizontal. Once a line is drawn, the line Length is the selected status field.

X  Y  dX  dY  **L**  A



### Drawing a Line Perpendicular to Another Object

1. Construct the object.
2. Move the pointer to the object until a Drafting Assistant **on** notation appears. The Drafting Assistant notation must be on rather than endpoint, quadrant, or midpoint.
3. Drag straight away from the object in a perpendicular direction. A *perpendicular* line appears attached to the object. Keep holding the mouse down and move the cursor. Notice that the line stays perpendicular but slides along the object.
4. Drag to the desired length for the perpendicular line.

### Drawing a Line Tangent to or Perpendicular to a Curve

1. Construct an arc, circle, or ellipse.
2. Choose the **Single Line** tool.
3. Move the pointer to the arc until a Drafting Assistant *on* notation appears. The Drafting Assistant notation must be *on* rather than *endpoint*, *quadrant*, or *midpoint*.
4. Drag in the appropriate direction (straight for perpendicular or at an angle for tangent) until the Drafting Assistant *perpendicular* or *tangent* notation appears.
5. When the Drafting Assistant locks on to *perpendicular* or *tangent*, drag the line around the arc to the desired location and extend the line to the necessary length.

### Creating a Point

Create a point by creating a line and setting its length to zero. Set the starting point of the line with the mouse, then type **0** in the Length entry field of the Status Line and press ENTER (Windows) or RETURN (Macintosh). The line ("point") displays a + to indicate its location. A 0 length line can also be created by clicking the **Single Line** tool twice in the same spot.

### ***Mid-Point Line Tool***



This tool, in the second subpalette of the main tool palette, creates a line that starts from the center and dynamically draws in both directions until the endpoint is clicked.

#### **Using the Mid-point Line Tool**

1. Select the tool. The Message Line reads, *Mid-Point Line: Pick center point.* The message guides each successive step.
2. Click to indicate where the mid-point of the line will be.
3. Indicate one end point and the line grows symmetrically in the opposite direction.

### ***Connected Lines Tool***



This tool, in the second subpalette of the main tool palette, draws lines in which the endpoint of one line segment is the beginning point of the next.

#### **Using the Connected Lines Tool**

1. Select the tool. The Message Line reads, *Connected Lines: Pick the beginning point.* The Message Line guides each successive step.
2. Indicate the endpoints of the line segments.  
If you click a point and then change your mind, press the ESC key, or choose *Undo* to remove the last line. Pressing the BACKSPACE (Windows) or DELETE (Macintosh) key removes all connected lines in the current construction.
3. Indicate the last point by double-clicking or by choosing another tool.

After completing at least one segment with the **Connected Lines** tool, it is possible to create a tangent arc off of the last line by holding down the CTRL (Windows) or the OPTION (Macintosh) key (the pointer temporarily changes to an “arc” icon) and clicking or dragging to the next point. The Message Line notes this added feature. Several tangent arcs can be strung together by continuing to hold down the CTRL (Windows) or OPTION (Macintosh) key. (Note: The radius of these arcs cannot be edited with this method.)

The Status Line specifies the X,Y coordinates of the beginning, the relative location of the end (delta X and delta Y), the line length and the angle from horizontal. Once the line segment is created, line Length is the selected status field. By entering successive sets of data and hitting ENTER (Windows) or RETURN (Macintosh) after each set, a continuous string of connected lines can be entered from the keyboard.

X  Y  dX  dY  L  A

### Construction Lines Tool



This tool, in the second subpalette of the main tool palette, constructs lines that help while drawing. Use the following methods for creating construction lines:

#### Using the Construction Lines Tool

1. Select the tool. The Message Line reads, *Construction Line: Pick beginning point*. The Message Line guides each successive step.
2. Click in the drawing area to specify the point through which the construction line should go.
3. Click once again with the mouse button indicating the another point through which the construction line must go.

The Status Line has the fields with the coordinates of the last construction line drawn. You can change the data in the Status Line fields and the line coordinates will change accordingly.

X  Y  Z  dX  dY  dZ  L  A

#### Referral:

For more information on construction lines see also "Permanent Construction Lines" on page 4-11

### ***Parallel Lines Tool***



This tool, in the second subpalette of the main tool palette, constructs lines parallel to existing lines. Use one of the following methods for creating parallel lines:

#### **Using the Parallel Lines Tool**

1. Select the tool. The Message Line reads, *Parallel Lines: Drag new line off existing line*. The Message Line guides each successive step.
2. Indicate the line to duplicate then drag to the new position. Enter the delta distance in the Status Line and press ENTER (Windows) or RETURN (Macintosh).

or

Click the line to duplicate then enter a delta distance in the Status Line and then press ENTER (Windows) or RETURN (Macintosh). (This method does not allow control of which side of the original line the new line is drawn.)



The status field specifies the distance between the original line and the new parallel line.

## Smart Wall Tool



The **Smart Wall** tool, in the second subpalette of the main tool palette, constructs a double line like those used in architectural drawings.

Please note: this tool functions correctly only in the **Top** view.

Results are not accurate if drawn in any other view.

This tool works in much the same way as the **Single Line** tool except that it draws double lines or walls.

Walls created on the same layer automatically trim to where they touch or intersect. Automatic trimming of smart walls occurs only when the walls are on the same layer. Dragging creates a rubberband smart wall, so that it is seen before it is drawn.

When dragging the mouse, the defining side of the wall falls on the construction line dragged along. The other side of the wall automatically fills in at the thickness specified in the Status Line. The position of the automatic wall depends on the last activity. If the second wall is on the wrong side of the construction line, press the SHIFT key to flip it. Notice the Message Line reads “Shift = Flip” as a reminder of this feature.

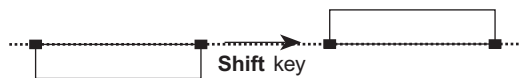

To fillet or chamfer or otherwise alter a Smart Wall layout, first ungroup them with the *Ungroup* command in the Arrange menu. The result is that the selected Smart Walls turn into separate line segments and the “smarts” are stripped out. This cannot be undone. Regrouping the pieces will not make them Smart Walls again. It is recommended to place all symbols before ungrouping and filleting/chamfering the walls.

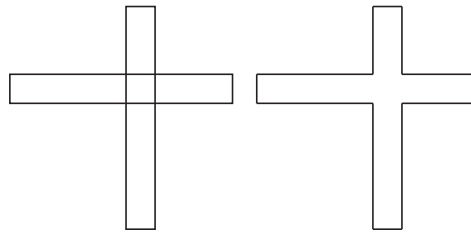

Overlapping lines are automatically trimmed at the intersections.

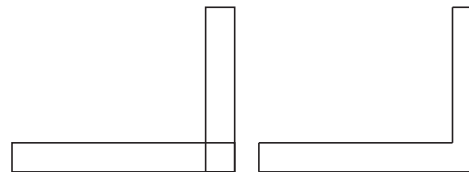

### Tip:

To use the Smart Wall feature for single lines, create the lines with the **Smart Wall** tool and enter **0** for the thickness of the wall.

### Using the Smart Wall Tool

1. Select the tool. The Message Line reads, *Double Line: Pick start point. [Shift = Flip]*. The Message Line guides each successive step.
2. In the Status Line, specify the thickness (T) of the wall.
3. Indicate the ends of the wall segment.  
Press the SHIFT key to flip the wall to the opposite side.
4. Continue specifying both endpoints for wall segments, as needed.

After deleting a merged segment, the remaining walls redraw.

The Status Line specifies the thickness of the wall, the X,Y coordinates of the beginning point, the wall length and the angle from horizontal. Once the wall segment is created, wall Length is the selected status field.

T  X  Y    A

### Wall Symbols

Parametric symbols (like door and window symbols) can be constructed in a way that automatically cuts an opening in the Smart Wall on which they are placed. Examples of this are included with Graphite in the Architect library within the Symbols folder. When moving the symbol along the wall to another position, the wall automatically closes at the old position and the opening appears at the new position.

1. The symbol must contain a Smart Wall piece that is thicker than the wall segment on which it will be placed.
2. Set the pen pattern of the smart wall piece to *dotted*. (Any geometry in a symbol that is of the dotted pen pattern is placed on the drawing, but it is invisible.) This results in an invisible Smart Wall piece that cuts the Smart Walls on the drawing.

Parametrics works with Smart Wall configurations, but it can be tricky. While using parametrics, turn on the point display (**Layout>Show Points**) and hook dimension objects right to the displayed points rather than to the lines. Keep in mind that double walls obscure the fact that smart walls are actually single lines.

For more information on parametrics, see Chapter 16.

## Arc Tools

Use the **Arc** tools to create an arc by any of three methods:

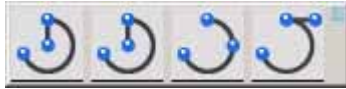

- Center-Point
- 3-Point
- Tangent Point

When creating each arc, the Status Line displays entries such as coordinate locations, radius, angle from horizontal and delta angle. Dragging creates a rubberband ellipse, so the ellipse is seen before it is drawn.

The arc is drawn with the current pen specifications for color, weight and pattern.

### Center-Point Arc Tool



This tool, in the third subpalette of the main tool palette, draws an arc from three points: the center point, arc beginning point and arc endpoint.

#### Using the Center-Point Arc Tool

1. Select the tool. The Message Line reads, *Center-Point Arc: Pick center. [Ctrl = Copy previous (Windows) or Option = Copy previous (Macintosh)].* The Message Line guides each successive step.
2. Indicate the *center* point of the arc.
3. Indicate the radius and beginning of the arc.

All three points can be clicked, but the rubberhand arc doesn't appear with this method. To construct an arc greater than 180°, drag rather than click, the endpoint.

The Status Line specifies the X,Y coordinates of the center of the arc, the length of the radius, the starting angle from horizontal and the delta angle from the start. Radius is the selected status field.

X  Y  **R**  A  dA

### 3-Point Arc Tool



This tool, in the third subpalette of the main tool palette, draws an arc through the points selected.

#### Using the 3-Point Arc Tool

1. Select the tool. The Message Line reads, *3-Point Arc: Pick first point. [Ctrl = Tangent to object (Windows) or Option = Tangent to object (Macintosh)].*
2. Indicate the first endpoint of the arc.
3. Indicate the second and third positions.

The arc is drawn from the first position designated, through the second position, and ends at the third position.

Clicking *on* a separate object while holding down the CTRL (Windows) or OPTION (Macintosh) key, the arc is drawn tangent to the specified object rather than through the exact click-point. For each of the three clicks that define the arc, if the CTRL (Windows) or the OPTION (Macintosh) key is held down and the cursor is placed on some other object, Graphite will define the arc to be *tangent* to that object at the nearest tangency point. If the CTRL (Windows) or OPTION (Macintosh) key is not held down, then the arc is created directly through that exact point. Each of the three points is treated separately.

The Status Line indicates the X,Y coordinates for each of the three points.

X1  Y1  X2  Y2  X3  Y3



### Tangent-Point Arc Tool



This tool, in the third subpalette of the main tool palette, draws an arc beginning at the first point specified. The second point specified is the direction vector and the third point indicates the endpoint of the arc. Essentially, the **Tangent-Point Arc** tool first creates a line, then creates an arc tangent to the line, then erases the line.

#### Using the Tangent-Point Arc Tool

1. Select the tool. The Message Line reads, *Tangent-Point Arc: Pick beginning point of arc (tangent line)*. The Message Line guides each successive step.
2. Indicate the starting point. This is both the starting point of the arc and the starting point of the temporary tangent line.
3. Indicate the endpoint of the tangent line.
4. Indicate the endpoint of the arc. The arc is drawn between the first and last point clicked and tangent to the line between the first and second points.

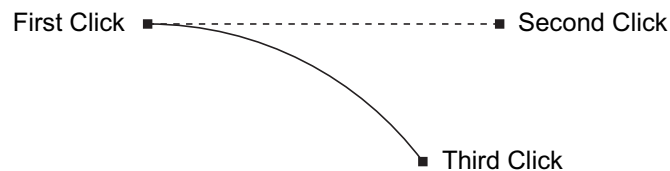

The Status Line specifies the X,Y coordinates of the endpoints of the arc and the angle of the tangent line.

X  Y  A  DX  DY

## Circle Tools

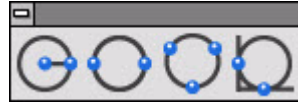

### *Tech Note:*

A **Circle Center Line** tool is available for creating axis dimensions. For more information, see Chapter 12.

The **Circle** tools on the tool palette construct circles by any of four methods:

- Center-Point
- Opposite-Point
- 3-Point
- Tangent

Center-Point uses the center and diameter of the circle. Opposite-Point uses the diameter. 3-Point uses three points and can be tangent to existing objects. Tangent-Point draws a circle tangent to two objects, using the diameter specified. Dragging creates a rubberband ellipse, so the ellipse is seen before it is drawn. The circle is drawn with the current pen specifications for Color, Weight and Pattern.

### ***Center-Point Circle Tool***



This tool, in the fourth subpalette of the main tool palette, draws a circle specified by the center point and diameter.

### **Using the Center-Point Circle Tool**

1. Select the tool. The Message Line reads, *Center-Point Circle: Pick center. [Ctrl = Copy previous (Windows) or Option = Copy previous (Macintosh)].*
2. Indicate two locations; the first click places the center and the second determines the radius.
3. To create a copy of the last circle, hold down the CTRL (Windows) or OPTION (Macintosh) key and click once in the center for the new circle.

The Status Line shows the X,Y coordinates of the center and the diameter of the circle. Diameter is the selected status field.

X 1 Y 1 **D** 1

### ***Opposite-Point Circle Tool***



This tool, in the fourth subpalette of the main tool palette, draws a circle specified by the diameter.

#### **Using the Opposite-Point Circle Tool**

1. Select the tool. The Message Line reads, *Opposite-Point Circle: Pick first point on circle. [Ctrl = Copy previous (Windows) or Option = Copy previous (Macintosh)].* The Message Line guides each successive step.
2. Indicate two locations for the diameter,

Create a copy of the last circle drawn by holding down the CTRL (Windows) or the OPTION (Macintosh) key and clicking once to place first point of the new circle.

The Status Line specifies the X,Y coordinates representing the endpoints of the diameter.

X  Y  dX  dY

### 3-Point Circle Tool



This tool, in the fourth subpalette of the main tool palette, draws a circle through the points selected.

#### Using the 3-Point Circle Tool

1. Select the tool. The Message Line reads, *3-Point Circle: Pick first point. [Ctrl = Tangent to object (Windows) or Option = Tangent to object (Macintosh)].* The Message Line guides each successive step.
2. Indicate the first point on the circle.
3. Indicate the second and third points.

If any of the three points are placed on an existing object, the circle is drawn through that point. By clicking an object while holding down the CTRL (Windows) or OPTION (Macintosh) key, the circle is drawn tangent to the object rather than through the indicated point. Combine the placement of these points to create a circle through a specific point of one object and tangent to another object, or a circle tangent to three objects, or any other combination.

The Status Line indicates the X,Y coordinates for each of the three points.

X1  Y1  X2  Y2  X3  Y3

### Tangent-Point Circle Tool



This tool, in the fourth subpalette of the main tool palette, draws a circle tangent to the two objects indicated.

#### Using the Tangent Circle Tool

1. Select the tool. The Message Line reads, *Tangent Circle: Enter diameter then pick first tangent object.* The Message Line guides each successive step.
2. Enter a diameter for the circle in the status field.

D

3. Click the objects to which the circle is to be tangent.

## Ellipse Tools



The **Ellipse** tools on the tool palette construct ellipses inscribed within an invisible rectangle or parallelogram by any of four methods:

- 2-Point Center
- Opposite-Corner
- 3-Point Center
- 3-Corner

The 2-Point Center Ellipse uses the center point and one corner location of the rectangle. The Opposite-Corner Ellipse uses opposite corners of a rectangle. The 3-Point Center Ellipse uses the center point, the midpoint of a side and the corner of the parallelogram. The 3-Corner Ellipse uses three corners on a parallelogram. Click or drag to create the ellipse. Dragging creates a rubberband ellipse, so the ellipse is seen before it is drawn.

The ellipse is drawn with the current pen specifications for Color, Weight and Pattern.

Ellipses do not have *center* points by design. By drawing lines between opposite *vertex* points on the ellipse, the *intersection* of the two lines is the center of the ellipse. For a 2-Point Center Ellipse (inscribed in a rectangle) the Drafting Assistant's horizontal and vertical temporary construction lines will cross at the center point once two *vertex* points are touched.

### 2-Point Center Ellipse Tool



This tool, in the fifth subpalette of the main tool palette, constructs an ellipse inscribed within the rectangle calculated from the two specified points: the center point and one corner of the rectangle.

#### Using the 2-Point Center Ellipse Tool

1. Select the tool. The Message Line reads, *2-Point Center Ellipse: Pick center of ellipse. [Ctrl = Copy previous (Windows) or Option = Copy previous (Macintosh)].* The Message Line guides successive steps.
2. Indicate the center of the ellipse.
3. Indicate the corner of the rectangle defining the ellipse.

If the two points are on the vertical or horizontal axis, a straight line is drawn.

To create a copy of the last ellipse, hold down the CTRL (Windows) or the OPTION (Macintosh) key and click in the center of the future ellipse.

The Status Line specifies the X,Y coordinates of the center point and the length and angle of the semi-major and semi-minor axes of the ellipse.

X  Y  L1  A1  L2  A2  90

### ***Opposite-Corner Ellipse Tool***



This tool, in the fifth subpalette of the main tool palette, draws an ellipse inscribed in the rectangle specified by the opposite corners indicated.

#### **Using the Opposite-Corner Ellipse Tool**

1. Select the tool. The Message Line reads, *Opposite-Corner Ellipse: Pick first corner of rectangle. [Ctrl = Copy previous (Windows) or Option = Copy previous (Macintosh)].* The Message Line guides successive steps.
2. Indicate one corner of the rectangle defining the ellipse.
3. Indicate the opposite corner of the defining rectangle.

If the two points are on the vertical or horizontal axis, a straight line is drawn.

To create a copy of the last ellipse, hold down the CTRL (Windows) or the OPTION (Macintosh) key and click the lower-left point of the future ellipse.

The Status Line allows specifying the X,Y coordinates of the lower-left point and the length and angle of the major and minor axes of the ellipse.

X  Y  L1  A1  L2  A2

### 3-Point Center Ellipse Tool



This tool, in the fifth subpalette of the main tool palette, constructs an ellipse inscribed within the parallelogram calculated from three specified points: the center point, the midpoint of a side and a corner of the parallelogram.

#### Using the 3-Point Center Ellipse Tool

1. Select the tool. The Message Line reads, *3-Point Center Ellipse: Pick center of the ellipse. [Ctrl = Copy previous (Windows) or Option = Copy previous (Macintosh)].* The Message Line guides successive steps.
2. Indicate the center of the ellipse.
3. Indicate the midpoint of the side of the rectangle defining the ellipse.
4. Indicate the corner of the rectangle defining the ellipse.

If the three points are on the vertical or horizontal axis, a straight line is drawn.

To create a copy of the last ellipse, hold down the CTRL (Windows) or the OPTION (Macintosh) key and click where the center of the future ellipse.

The Status Line specifies the X,Y coordinates of the center point and the length and angle of the sides of the parallelogram.

X  Y  L1  A1  L2  A2  90



### 3-Corner Ellipse Tool



This tool, in the fifth subpalette of the main tool palette, draws an ellipse inscribed in the parallelogram calculated from the three corners specified.

#### Using the 3-Corner Ellipse Tool

1. Select the tool. The Message Line reads, *3-Corner Ellipse: Pick first corner of control parallelogram. [Ctrl = Copy previous (Windows) or Option = Copy previous (Macintosh)].* The Message Line guides through each successive step.
2. Indicate one corner of the parallelogram defining the ellipse.
3. Indicate another corner of the defining parallelogram.
4. Indicate the final corner of the defining parallelogram.

If the three points are on the vertical or horizontal axis, a straight line is drawn.

To create a copy of the last ellipse, hold down the CTRL (Windows) or the OPTION (Macintosh) key and click where the lower-left corner of the future parallelogram.

The Status Line specifies the X,Y coordinates of a corner and the length and angle of the sides of the parallelogram.

X  Y  L1  A1  L2  A2  90

### Polygon Tools



These tools on the tool palette draw rectangles, inscribed polygons or circumscribed polygons. They create lines which are individual objects. To treat a polygon as a single object, select all lines of the polygon and choose the Group command in the Arrange menu.

Dragging to indicate the points of the polygon creates a rubberband image. The polygon is drawn with the current pen specifications for Color, Weight and Pattern.

### ***Rectangle Tool***



This tool, in the sixth subpalette of the main tool palette, draws a horizontal or vertical rectangle, using the opposite corners specified.

#### **Using the Rectangle Tool**

1. Select the tool. The Message Line reads, *Rectangle: Pick first corner of rectangle. [Ctrl = Copy previous (Windows) or Option = Copy previous (Macintosh)].*
2. Indicate the opposite corners of the rectangle,

Create a square by aligning the second point on the 45° construction line. If the two points are on the vertical or horizontal axis, a straight line is drawn. To draw a square from the center rather than opposite corners, use one of the other polygon tools, specifying four sides. It is not possible to create a rectangle from the center.

Changing the Width and the Height of a rectangle in Edit Objects dialog box is not possible. Each line must be edited individually because rectangles become four line objects after deselecting the rectangle.

Create a copy of the last rectangle by holding down the CTRL (Windows) or the OPTION (Macintosh) key and clicking where to place the upper-left corner of the future rectangle.

A default 1-inch rectangle is drawn if a rectangle has not been previously drawn.

The Status Line specifies the X,Y coordinates of the first point, as well as the width and height of the rectangle. Width is the selected status field.

X  Y  **W**  H

### ***Inscribed Polygon Tool***



This tool, in the sixth subpalette of the main tool palette, draws a regular polygon where the radius of the circumscribing circle determines the location of the polygon's vertices.

The default polygon is a hexagon, but specifying the number of sides is possible in the Status Line. The Status Line shows a diameter for the circle, the standard way of describing a polygon inscribed in a circle.

### Using the Inscribed Polygon Tool

1. Select the tool. The Message Line reads, *Inscribed Polygon: Pick center of polygon. [Ctrl = Copy previous (Windows) or Option = Copy previous (Macintosh)].* The Message Line guides successive steps.
2. Indicate the center of the polygon.
3. Indicate a point on the circumference of the circumscribing circle.

Create a copy of the last inscribed polygon by holding down the CTRL (Windows) or OPTION (Macintosh) key and clicking where you want the center.

The Status Line specifies the X,Y coordinates of the center, the diameter of the circle defining the polygon, and the number of sides. Diameter is the default Status Line selection, and the default number of sides is six.

X  Y  **D**  Sides

### Circumscribed Polygon Tool



This tool, in the sixth subpalette of the main tool palette, draws a regular polygon for which the radius of the circle determines the midpoint of the sides. The default shape is a hexagon, but it is possible to specify the number of sides in the Status Line. (Note: The Status Line shows a diameter for the circle, the standard way of describing a polygon circumscribed around a circle.)

### Using the Circumscribed Polygon Tool

1. Select the tool. The Message Line reads, *Circumscribed Polygon: Pick center of polygon. [Ctrl = Copy previous (Windows) or Option = Copy previous (Macintosh)].* The Message Line guides successive steps.
2. Indicate the center of the polygon and the midpoint of one of the sides

Create a copy of the last circumscribed polygon by holding down the CTRL (Windows) or OPTION (Macintosh) key and clicking where you want the center.

The Status Line specifies the X,Y coordinates of the center, the diameter of the circle defining the polygon, and the number of sides. The default number of sides is six. Diameter is the default Status Line selection.

X  Y  **D**  Sides

## Spline Tools

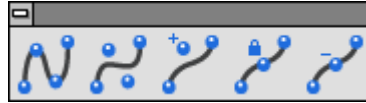

The spline tools on the tool palette create NURBS (Non-Uniform Rational B-Splines) which are a superset of Bezier curves. These splines are curves created by a complex mathematical formula.

NURB splines provide designers with two interrelated functions. First, curvature continuity remains intact when the curve is changed. Kinks don't develop as the spline is altered. Second, NURB splines provide localized control of a complex curve. Isolate an area and make changes without affecting the remainder of the spline.

These properties are essential in aerodynamic designs. Air molecules moving over a wing surface must flow smoothly for maximum aero-dynamic lift. If the surface does not maintain curvature continuity, the air molecules separate from the wing surface and cause a vacuum. Such a vacuum causes an eddy as the molecules try to fill it. This disruption of air flow increases the drag, which is not a part of an effective design.

The automotive industry needs smooth air flow to improve gas mileage. Complete curvature continuity also improves styling. The appearance of a car is one of the major sales factors. The potential buyer would not be impressed if the showroom lights' reflection on the car rippled and wavered. It is complete curvature continuity that makes a smooth reflection.

Localized control of complex curves allows minor modifications to be made without adversely affecting the shape. For example, if a new, bigger engine doesn't fit under a perfectly-designed hood, use a NURB spline to raise the center of the hood without changing the basic design.

NURB splines are also valuable for injection mold designs to eliminate the swirl of plastic as it is injected into the mold. Such designs provide better surface finishes and allow thinner cross-sections in the die.

### Through-Points Spline Tool



The **Through-Points Spline** tool, in the seventh subpalette of the main tool palette, draws a spline through the points placed.

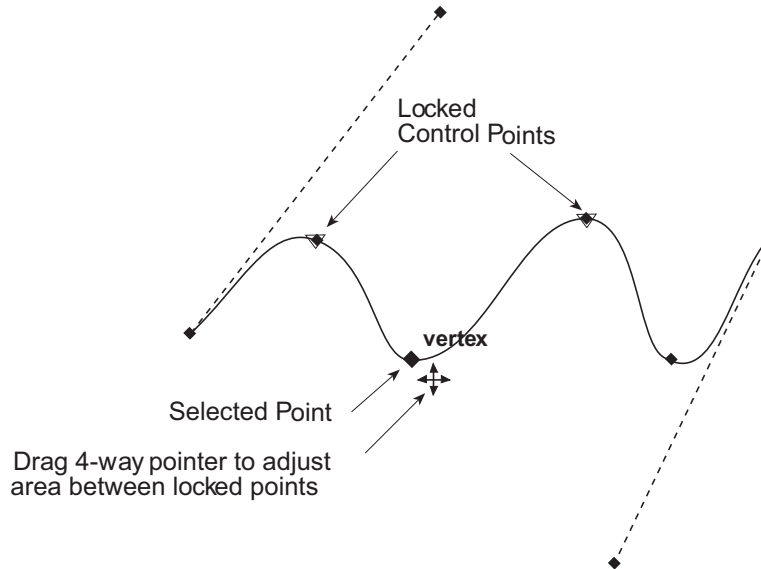

### Using the Through-Points Spline Tool

1. Select the tool. The Message Line reads, *Through-Points Spline: Pick control point (Double-click last point)*.
2. Indicate the points for the vectors of the spline.
3. Double-click the last point.

The Status Line shows the X,Y, and Z coordinates of each point along the path. (Graphite shows only X and Y coordinates.)

X  Y  Z

If a spline crosses over itself, the Drafting Assistant will not be able to find that intersection. This is by design.

### Vector Spline Tool



This tool, in the seventh subpalette of the main tool palette, draws a spline using vectors determined by the points specified. The **Vector Spline** tool uses each point placed as the vertex of a vector for the spline it creates.

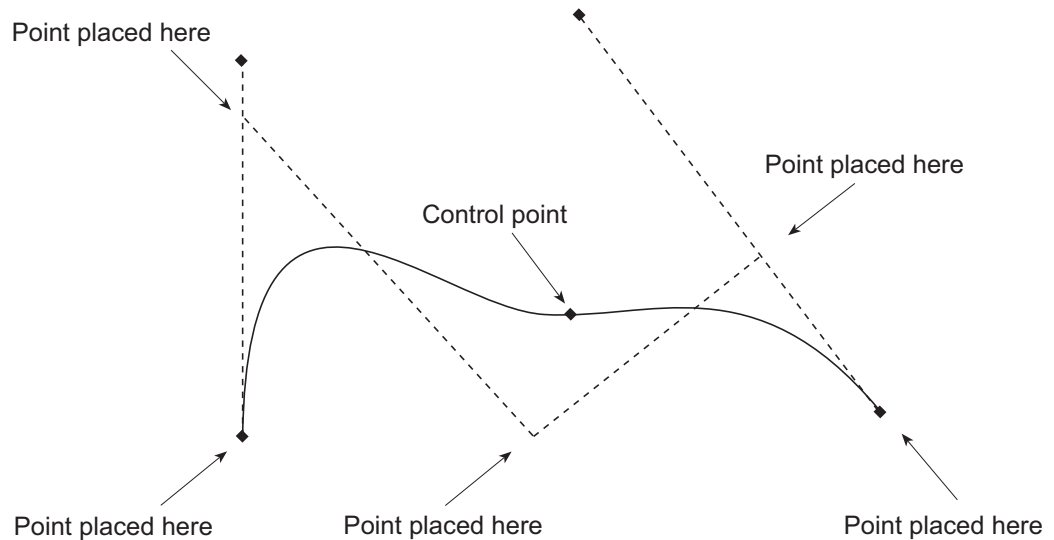

#### Using the Vector Spline Tool

1. Select the tool. The Message Line reads, *Vector Spline: Pick control point (Double-click last point).*
2. Click the points for the vectors of the spline.
3. Double-click the last point.

Graphite uses these vectors to calculate the control points (two fewer than the number of vertices specified). The spline is tangent to the first and last vectors and passes through the calculated control points.

The Status Line shows the X,Y, and Z coordinates of each point along the path.

X  Y  Z

### ***Add Spline Control Point Tool***



This tool, in the seventh subpalette of the main tool palette, adds another control point to an existing spline.

#### **Using the Add Spline Control Point Tool**

1. Select the tool. The Message Line reads, *Add Spline Control Point: Pick location on spline.*
2. Click on the spline at the desired location(s) for the new control point(s).

**Note:** To see the new control point(s), as well as the existing control points, first select the spline and then choose **Layout>Show Points** (or use the Edit Objects dialog box to specify display points).

To move a point, be sure to lock the adjacent points so you don't change the slope of the rest of the spline.

## Lock Spline Control Point Tool



This tool, in the seventh subpalette of the main tool palette, locks specified points on an existing spline so that the slope between the points can be changed without affecting the rest of the spline.

### Tech Note:

The *Lock* command in the Arrange menu is used to prevent changes to objects and doesn't affect spline control points.

### Using the Lock Spline Control Point Tool

1. Select the spline.
2. Choose **Layout>Show Points**.
3. Select the tool. The Message Line reads, *Lock Spline Control Point: Pick control point*.
4. Click the *vertices* to lock. The **Lock Spline Control Point** tool is used to lock or immobilize selected control points on an existing spline. Then adjust the curvature of the spline between the locked points without disturbing other areas of the spline.

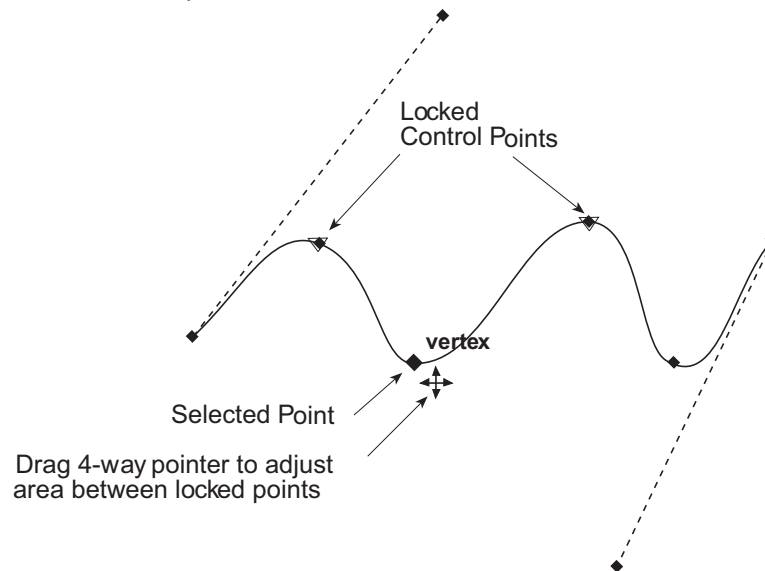

### Unlocking Spline Control Points

1. Select the tool and click on the point to unlock it.

### Locking More than One Spline Control Point

1. Lock more than one point by simply clicking each point.



### Editing Control Points of a Spline

1. Select the spline with the **Selection** tool.
2. Choose **Layout>Show Points**. (If the menu says *Hide Points*, no need to choose it.)
3. Click on the drawing area to deselect the spline.
4. If necessary, select the **Lock Spline Control Points** tool from the **Spline** tool subpalette.
5. If necessary, click the points to lock (the points on either side of the point to be changed).
6. Use the **Selection** tool to select the point to change.
7. Drag the point to the new location.

The dotted lines that appear tangent to the end portions of the spline are *tangent control arms*. They adjust the curvature of the spline leading up to the endpoints without moving the endpoints themselves. To do this, select the *endpoint* of the tangent control arm and drag it to another location with the 4-way pointer that appears.

### Editing the End Slope of a Spline

1. Select the spline with the **Selection** tool.
2. Choose **Layout>Show Points**. (If the menu says *Hide Points*, no need to choose it.)
3. Click in the drawing area to deselect the spline.
4. If necessary, select the **Lock Spline Control Points** tool from the **Spline** tool subpalette.
5. If necessary, select the point to lock but not the endpoint.
6. Use the **Selection** tool to select the point at the end of the tangent control arm that needs to be moved.
7. Drag the point to a new location.

It is not possible to move both *endpoints* of a spline at the same time. Select and move the *endpoints* individually.



# 3D Drawing Tools

The process of moving from 2D to 3D geometry creation is relatively seamless. All of the tools used to create 2D geometry in Graphite are also used to create 3D geometry. However, there are some tools, features and concepts that are specific to 3D. The following topics are covered in this chapter:

- Geometry in 3D
- 3D Features and Tools
- Work Plane

## ***Geometry in 3D***

Graphite tools behave in predictable ways in 3-dimensional space. Once you know the rules, manipulate the tools to construct the necessary geometry.

In traditional 3D computer-aided design, it is necessary to establish everything on work planes. It is as though a piece of glass has been propped on one of the faces of the model and you must draw on that plane. To work on a different plane, you must figuratively pick up the glass and carry it to the new position. With Graphite, it is possible to work freely within the model, using work planes or not as necessary. Move around inside the model and draw wherever desired. Generally, the only concern is the design, not moving the piece of glass.

The Drafting Assistant keeps tabs on the angles and intersections in all three dimensions. If geometry exists, draw relative to it. When it is simpler to use a work plane, or no geometry exists which is relative to the necessary plane, simply move Graphite's on-demand work plane with the *Planes*, *3-Point Plane* and *Define Plane* commands in the 3D menu.

*Referral:*

Work planes are discussed later in this chapter.

For example, to put a circle in the work plane or parallel to the work plane, it is possible to use tools which require only two specification points, such as the **Center-Point Circle** tool or the **Opposite-Point Circle** tool. To put a circle on a non-parallel plane, then use three-point specification tools, such as the **3-Point Circle** tool or **Tangent-Point Circle** tool.

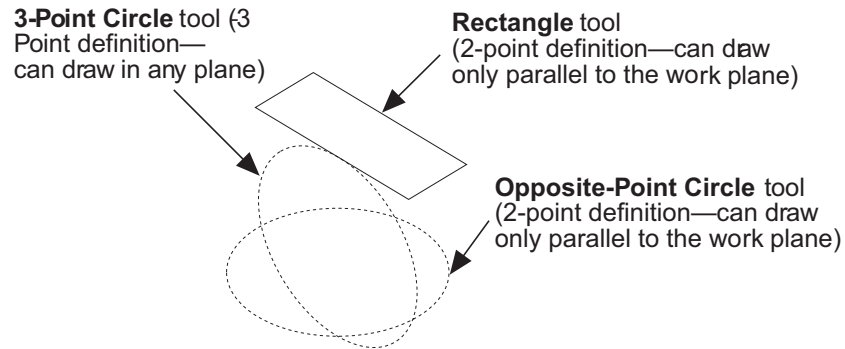

When a tool creates geometry from two points, the geometry lies on a plane parallel to the work plane. If the tool uses three points to define the geometry, the geometry will lie on the plane defined by the three points.

If the geometry does not specify three points (or two entities) in the necessary plane simply move the work plane.

#### Reminders:

There are two ways to see geometry in 3D:

- In the Views menu, choose *Views* and select a view. The default views are Isometric, Right, Front, Top and Trimetric.
- In the Views menu, choose *Show Trackball*. When the Trackball appears select a view from its own menu.

Three dimensional geometry is created or viewed using the Triad to display the orientation of the work plane on which the drawing is performed. The *Show Triad* command is located in the 3D menu. See Chapter 6 “Advanced Environment Settings” for more information on the Trackball and the Triad.

## Construction Rules for Tools Used in 3D

### Lines

Single, connected and parallel lines have no 3D restrictions.

Tangent lines pulled off a curve, circle or spline will be tangent if created in the same plane as the curve, circle or spline.

Tangent lines that are tangent to only one object can be created only with objects on the work plane at the origin. Tangent lines tangent to two objects can be created on any work plane as long as both objects are on the same work plane.

### Arcs

A center-point arc is drawn parallel to the work plane.

A 3-point arc is drawn in the plane designated by the three points defining the arc.

A tangent-point arc is drawn in the plane of the three defining points.

### Circles

A center-point circle and opposite-point circle are drawn parallel to the work plane.

A 3-point circle is drawn in the plane designated by the three points defining the circle.

A tangent circle is drawn in the plane of the two defining entities.

### Ellipses

A 2-point center ellipse and opposite-point ellipse are drawn parallel to the work plane.

A 3-point center ellipse and 3-corner ellipse are drawn in the plane designated by the three points defining the ellipse.

### Rectangles

All rectangles and polygons are created parallel to the work plane.

### Splines

Splines have no 3D restrictions.

**Fillets/Chamfers**

Fillets and chamfers are constructed in the plane defined by the selected entities.

**Tracer**

This tool does not work with 3D objects.

## ***3D Features and Tools***

Graphite provides tools and features specific to the 3D environment.

### **Extrude Command**

This command, in the 3D menu, takes 2D geometry and makes it 3D through a simple extrusion process. There is also the option to extrude as a surface.

When you begin thinking about using this command, consider the following points:

- Which face shows the most detail?
- Will the extrusion be uniform or do some portions of the part have different dimensions?

For example, the top view of a bracket provides the most detail. Draw it with the **Connected Lines** tool on the tool palette.

Once the basic shape is drawn, use the *Extrude* command from the **3D** menu to create the depth of the bracket.

Once extruded, add some circles and extrude them to create holes in the bracket.

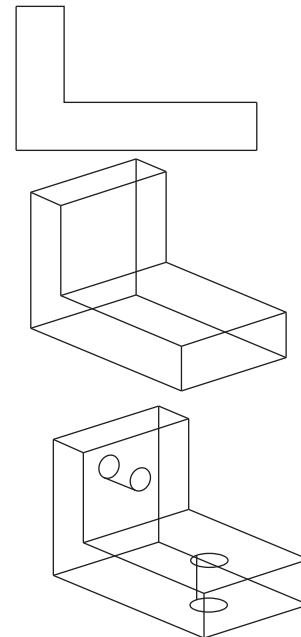

### Using the Extrude Command

1. Draw the geometry to be extruded.
2. Select the geometry if it is not already selected.
3. Choose **3D>Extrude**.

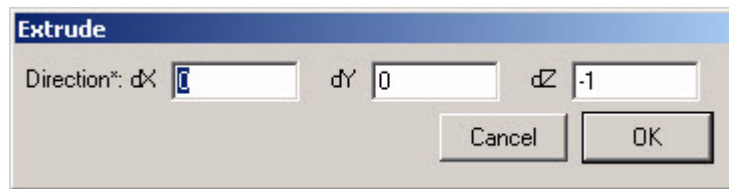

4. Enter the distance and direction or drag to specify the extrusion. Positive or negative values indicate the direction.  
Use the Tab key to move between the x, y, and z coordinate data fields.
5. Click OK and the geometry is extruded.

#### Notes:

- X and Y are on the current work plane and Z is perpendicular to that plane. This is not necessarily relative to the original x, y, z axes that were used when the geometry was constructed.
- If the object was drawn in the x,y plane, the extrusion should be in the z-direction. Therefore enter a z-value in the dialog box. Think of the screen as the 0 coordinate with positive values extending toward you and negative values away from you.
- Manipulate the work plane to determine the direction of an extrusion.

## Revolve Command

The *Revolve* command, in the 3D menu, creates a model as though it were turned on a lathe. It copies and revolves a 2D object into a 3D object. There is the option to surface the geometry at the same time it is revolved.

Begin by drawing half of the model on an axis for revolving.

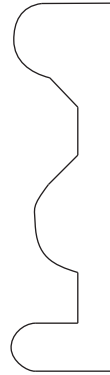

Then use the *Revolve* command to revolve the image a specified number of steps and angles.

Finally, show the Trimetric view to see more detail of the wireframe.

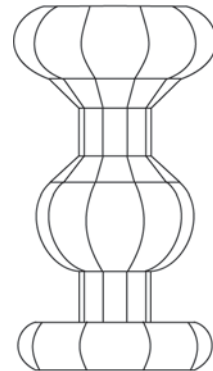
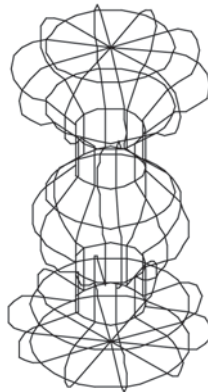



### Using the Revolve Command

1. Draw the geometry to be rotated.
2. Select the geometry if it is not already selected.

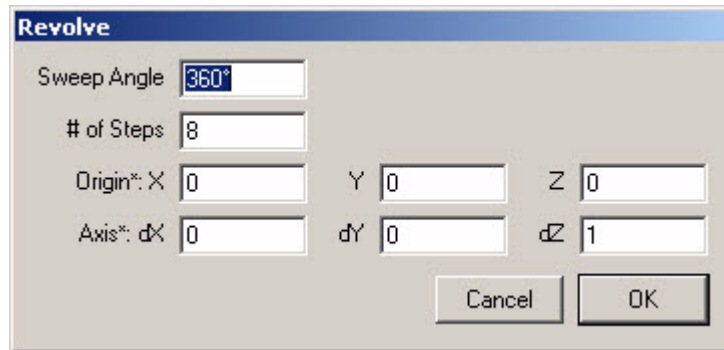

3. Choose **3D>Revolve**. The Revolve dialog box displays.
4. Specify the number of degrees in the *Sweep Angle* for the revolution.
5. Specify the *number of Steps* (copies or divisions).
6. Tab to the *Origin* data field in the dialog box.
7. Place the target cursor at the startpoint of the axis of revolution.
8. Drag along the axis from the startpoint to the endpoint. The six data fields are automatically filled in.
9. Click OK and the selected geometry is now revolved around the axis as specified, according to the right hand rule of revolution.

*Tip:*

Use the Tab key to move through the data fields.

*Tip:*

To establish the axis of revolution, click the startpoint and the endpoint.

### Right-hand Rule of Revolution

The direction of revolution is determined by the right-hand rule of revolution which states that if the thumb is pointed toward the positive axis of revolution, the revolution is in the same direction in which the fingers are curled.

**Note:** When revolving a circle that is eventually surfaced, the Axis of Revolution should be on an *endpoint* not a *quadrant*.

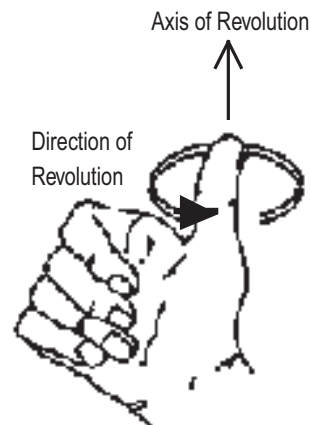

## Object Rotation Command

The Object Rotation command in the 3D menu, rotates geometry around any specified axis.

1. Select the geometry to rotate.
2. Choose **3D>Object Rotation**.

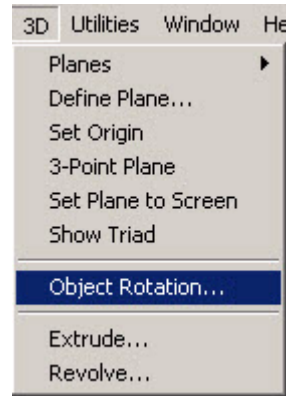

3. In the *Rotate Angle* field, enter the angle to rotate the geometry.

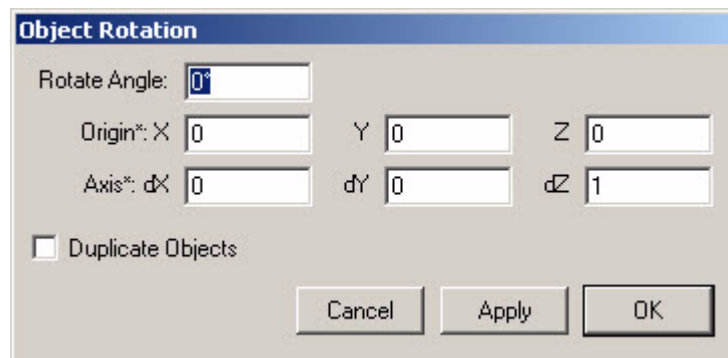

4. Tab to the Origin Data field. The cursor becomes a crosshair.
5. Click a point on the geometry to specify the *Axis of Rotation* around which to rotate the geometry.
6. Place the target cursor along the desired axis. Think of it as pointing to the top of a hinge.

7. Drag along the desired axis, as if dragging along the length of the hinge. Don't worry about whether the z-axis is pointed in the right direction. The six data fields are automatically completed.
8. Click OK. The object rotates. Change the view as necessary to observe the change in rotation.

## Work Plane

The Work Plane is the plane on which the geometry is created. It is an x, y plane with an origin of 0, 0, 0 for all data input. Move the work plane as desired by creating your own or choosing one of the standard work planes available in Graphite.

While learning to use Graphite, try to use the Drafting Assistant without moving the work plane. Even though the Drafting Assistant does a lot of the work, the work plane is still an essential element of 3D modeling.

The Z-Drafting Assistant assumes that geometry is being created in the current work plane unless it snaps to an *align:z* or to a logical snap point that is not in the current work plane.

Creating the geometry that is not parallel to the current work plane and that does not snap to one of the Drafting Assistant's constraints like *endpoint* or *midpoint*, and when using a tool that requires only two points for creation, such as the **Center-Point Circle**, **Rectangle**, or **2-Point Ellipse**, use a work plane to place the geometry properly. Also, tools which use three points for specification can be drawn non-parallel to the work plane.

## Planes

This command, in the 3D menu, displays the Planes submenu to set the current work plane. The standard work planes—Front, Right, Top and World—are always displayed, as well as any temporary plane generated (TempPlane) and any planes created with the *Define Plane* command. See margin notes.

### *Tech Note:*

If a work plane is named Temp Plane, it was created with the *3-Point Plane* command and will exist only for the duration of the current Graphite session. Rename the TempPlane work plane with the *Define Plane* command to make it a permanent plane for that file.

Also, there can only be one plane called Temp Plane in a document. If another plane is created using the *3-Point Plane* command, without changing the name of the first, the new Temp Plane replaces the old one.

### Setting the Work Plane

1. Choose **3D>Planes**.

The Planes submenu displays.

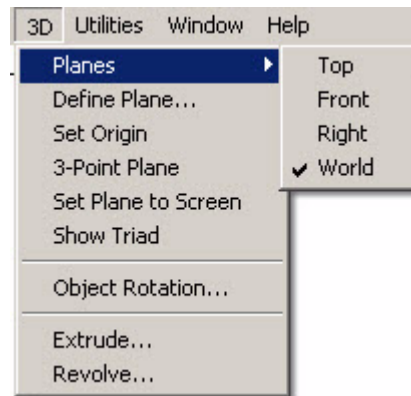

2. Drag down the submenu until the plane highlights.
3. Release the mouse button.

The work plane in the sheet view or active view window rotates as specified, and the work plane name is checked in the submenu.

Since only the plane is changed, the appearance of the geometry and its view orientation, remains unchanged. Therefore, it is possible to set the view to match the current work plane.

To move both the origin and change the orientation of the work plane, use either the *3-Point Plane* command or the *Define Plane* command.

## Specifying the Position of the Work Plane

In conventional CAD-programs it is necessary to specify both the orientation of the work plane and its exact location along the z-axis. In Graphite only the orientation of the work plane is specified. Once that is done, then all planes parallel to that orientation act equally as the current work plane, e.g. the Drafting Assistant identifies the location of the work plane automatically.

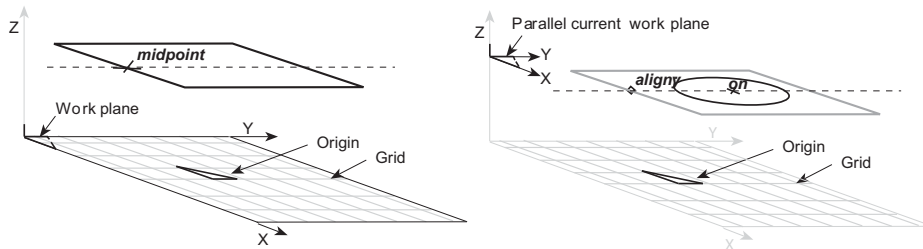

By identifying on point of an object with the Drafting Assistant...

...the new object geometry is created on the plane of that object .

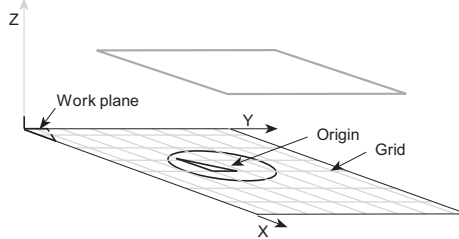

If an existing object is not identified with the new object, the new geometry is placed on the work plane of the origin.

Another way to explain the relationship presented in the graphics above, is to remember the role of the Drafting Assistant. For new geometry to be placed on the same plane as another piece of geometry, brush over that existing geometry to wake up one of its control points like midpoint or endpoint. Graphite will then retain this plane information while creating the new geometry.

If no object exists or no geometry is referenced for plane information, Graphite places the new object geometry onto the work plane at the origin.

### ***The Origin and the Work Plane***

Occasionally, when working on a model, it may be necessary to move the origin of the work plane. This is especially useful for measuring distances. For example, open a document and start drawing without regard to the location of the origin, then move the origin to a convenient location for future reference.

Choose **Layout>Show Grid** to display the origin.

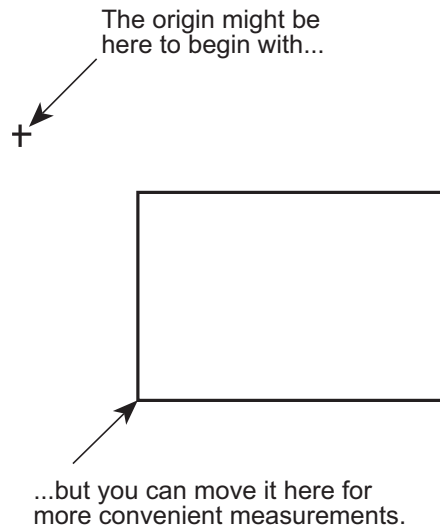

### **Set Origin Command**

This command, in the 3D menu, sets a new origin in the current work plane.

1. Choose **3D>Set Origin**.
2. Click in the drawing area to indicate the location for the new origin.

The origin of the current work plane is moved while the orientation of x,y,z remains the same.

To move the origin and change the orientation of the work plane, use either the **3-Point Plane** command or the **Define Plane** command.

## Setting a New Work Plane

It is possible to define a work plane other than the standard planes. For example, to work on an angled face, reorient the work plane.

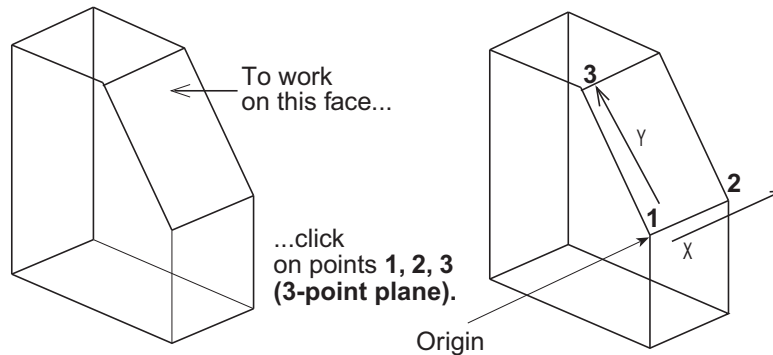

Define a new plane using two commands on the 3D menu, *3-Point Plane* and *Define Plane*. To define a new work plane specify the origin and indicate the horizontal and vertical directions. Use *3-Point Plane* to set the work plane, and then use *Define Plane* to name and save the plane.

### **3-Point Plane Command**

This command, in the 3D menu, sets a temporary work plane from the three points specified. Follow the directions in the Message Line.

1. Choose **3D>3-Point Plane**.
2. Click in the drawing area to indicate the point for the origin of the new work plane.
3. Click a point to define the positive x-axis.
4. Click a point to define the positive y-axis.

A temporary work plane is created and named TempPlane. The work plane moves, but the view does not change.

Rename this plane by going to the 3D menu and choosing *Define Plane*. There is an option to *Rename* in the dialog box. See a later section for more information. If the new plane is not renamed, it is replaced by the next specified *3-Point Plane* and removed from the list when exiting Graphite.

### ***Define Plane Command***

This command, in the 3D menu, defines a new work plane, names a temporary plane or changes a standard plane. The standard planes cannot be changed unless the lock icon is clicked off. Their default configurations are defined as follows:

<b>Front</b>	The x,z plane.
<b>Right</b>	The y,z plane.
<b>Top</b>	The x,y plane.
<b>World</b>	The origin and plane of the original geometry when it was created. This plane cannot be changed.

When changing any of the standard planes, always revert to the world plane to return to the original orientation.

Having used other CAD applications, you may be familiar with the terms *World Coordinate System* and *User Coordinate System*. The World Coordinate System is equivalent to Graphite's *world work plane* and the User Coordinate System is equivalent to the *current work plane*.



## Specifying a New Work Plane

1. Choose **3D>Define Plane**.

The Define Plane dialog box displays.

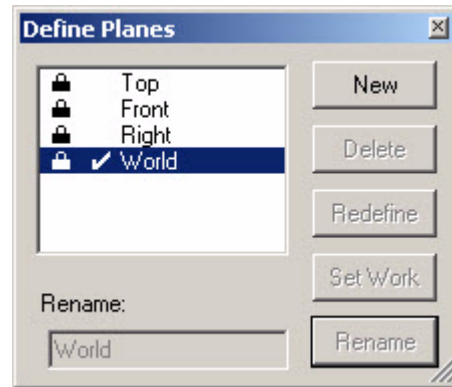

2. Click New.

The Redefine Plane dialog box displays and the *Origin* data field highlights.

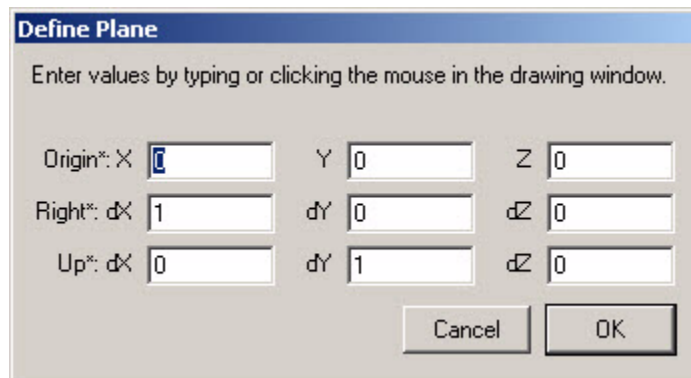

The new work plane is named Plane 1 by default.

3. On the drawing area, click the location for the new origin.  
The *Right* data field is selected.
4. Click a location on the positive x-axis.  
The *Up* data field is selected.
5. Click a location on the positive y-axis.
6. Click OK.

The definition box goes away and the new plane is defined. The new work plane is named Plane 1 by default. If this plane is not renamed, the next plane created will be Plane 2.

7. Select Plane 1, the new plane just created.
8. Click Set Work.

The current plane changes to the new specification.

9. Rename this work plane if desire.
10. Dismiss the dialog box if it is no longer needed to define other work planes.

Be aware that simply changing the work plane does not mean that work done is on the visible face. The view orientation must be adjusted accordingly.

## Renaming a Plane

1. Choose **3D>Define Plane**.
2. If necessary, click the lock icon to unlock the plane, then click the plane to be renamed in the list box.
3. Type a new name.
4. Click Rename.

The plane is renamed. If the renamed plane was a temporary plane, it becomes permanent. The name is added to the Planes submenu and the list in the Define Plane dialog box.

The World plane cannot be renamed.

## Deleting a Plane

1. Choose **3D>Define Plane**.
2. If necessary, click the lock icon to unlock the plane and then click the plane to be deleted from the plane list.
3. Click Delete.

A plane cannot be deleted if it is set as the current work plane. First make another plane the current work plane and then it can be deleted.

To delete a standard plane (Front, Right, or Top), unlock it. World plane cannot be deleted. To delete a standard plane, do not choose *Save Preferences*. In this case, the plane must be recreated for use in future files.

## Redefining a Plane

Use *Define Plane* to change the origin or orientation of the axes of any plane, except the World plane.

1. Choose **3D>Define Plane**.
2. Click the lock icon on the plane to be changed.
3. Click the name of the plane to change it.
4. Click Redefine.  
The Redefine Plane dialog box displays the settings as they appear on the screen with the origin selected.
5. On the drawing area, click the location for the new origin.  
The *Right* data field is selected.
6. Click a location on the positive x-axis.  
The *Up* data field is selected.
7. Click a location for the positive y-axis.
8. Click OK.

The plane is redefined.

The standard work planes—Front, Right, and Top— cannot be redefined without unlocking them. The World plane, which was established from the original orientation of the model, cannot be redefined.

## Set Plane to Screen

This command, in the 3D menu, sets the work plane to be coincident with the screen, where the origin is in the center of the screen; the x-axis is coincident with the width of the screen and the y-axis is coincident with the height of the screen.

This sets the plane to match the screen in all views which is particularly useful when moving from view to view while drafting.

To name this work plane, use the *Define Plane* command.

# Selecting Objects

Once objects have been constructed, they can be changed. One of the basic rules of Graphite says that an object should be selected before editing. Just as selecting a drawing tool from the tool palette before starting to draw, an object must first be selected before a function can be applied.

Modifying an object is always a two-step process:

1. Select the object.
2. Specify the action for the selected object.

For example, select a circle and then change the pen style to *Center* to indicate a bolt-hole circle.

The following topics are covered in this chapter:

- Objects
- Indicating Selection
- Selection Process

## Objects

A single piece of geometry is an object.

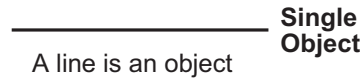

Several objects that have been grouped with the *Group* command are also an object.

For example, the four lines of a rectangle are four objects. By grouping them, Graphite treats them as a single object.

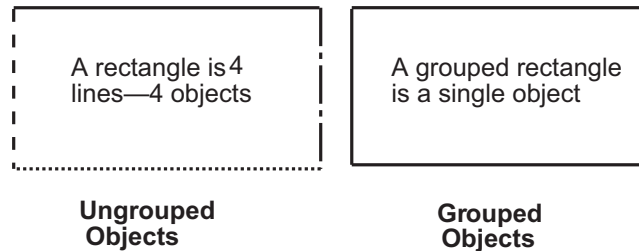

A point is an object, too. Every type of geometry contains two or more points, sometimes called *control points*. A line has two control points, one at the beginning and one at the end of the line. By selecting an object and choosing **Layout>Show Points**, the points are visible on the selected object.

### Referral:

Selecting points is described in a later section of this chapter.

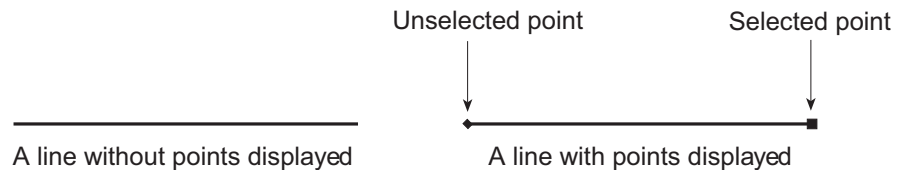

Keep in mind, that an object must be selected first, followed by the command to execute a function.

By selecting a point without selecting the geometry it defines, Graphite treats the point as an object.

## Indicating Selection

Upon selecting an object, its appearance on the screen shows that it is selected. It is a specific color (such as red), it blinks, or both. It is possible to change the color and turn blinking on and off for the selection indicator.

### Selection Command

This command, found under **Layout>Preferences**, determines the appearance of selected objects.

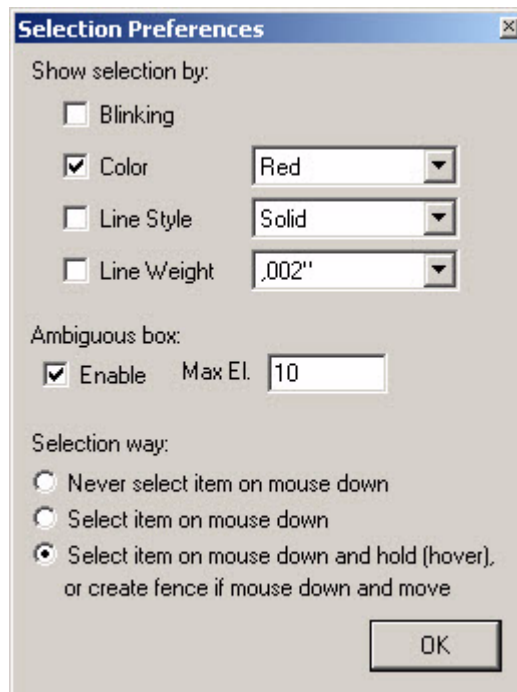

To choose a color, move the pointer to the color box and click on the color name to display the color list. Drag to the desired color and release or click the color. Once the selection color is changed, all current and future selected items appear in the new color.

Do not use black for indicating selection because many of the standard pens use black lines.

## Selection Process

Selecting an object does not affect the properties of the object. A selected object highlights, but this highlighting goes away once the object is deselected. While points and objects are selected in a similar way, point selection is controlled by the *Selectable Points* setting in the Edit menu. For this reason, selecting objects and selecting points are discussed separately.

Graphite provides **Selection** tools and commands for selecting the objects.

### Selecting Tools

There are five selection tools: **Selection**, **Tracer**, **Select by Line**, **Select by Polygon** and **Eyedropper**.



#### Selection Tool



The **Selection** tool, in the first subpalette of the main tool palette, selects one or more objects or points in the drawing area.

#### Selecting a Single Object

1. Click the **Selection** tool in the tool palette. The Message Line reads, *Select: Select [Shift = Extend, Ctrl = Copy (Windows) or Option = Copy (Macintosh)].*



2. Move the pointer to an object and click. The object is selected, and any previously selected objects are deselected.

#### Selecting Multiple Objects Using the SHIFT key

1. Click the **Selection** tool in the tool palette.
2. Move the pointer to an object and click.
3. Press down the SHIFT key.
4. While holding down the SHIFT key, click other objects to be selected.

The objects clicked on are selected. Clicking one of the selected objects deselects it.

5. Release the SHIFT key.



### Selecting Multiple Objects by Dragging

To select more than one object, drag a selection fence around the objects.

1. Click the **Selection** tool in the tool palette.
2. Drag a selection fence around the objects to select it.

All objects that lie completely inside the selection fence are selected. If a portion of an object is outside the region being dragged on, that geometry is not selected but the control points of the geometry which lie inside the selection fence are selected.

To select most of the objects within an area, drag a selection fence to select all the objects, and then deselect the objects by holding down the SHIFT key and clicking them.

### Selecting All Objects

Select all objects by double-clicking on the **Selection** tool.

### Select by Line Tool



This tool, in the first subpalette of the main tool palette, selects one or more objects along a straight line path when dragging a line over the desired objects.

1. Choose the **Select by Line** tool in the **Selection** tool palette. The Message Line reads, *Select By Line: Draw line [Shift = Extend, Ctrl = Copy (Windows) or Option = Copy (Macintosh)].*
2. In the drawing area, drag across the objects you want to select, as shown in the graphic below.

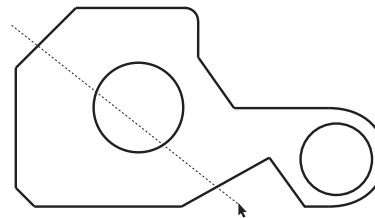

The objects intersected by the line are selected, as shown below in gray, and any previously selected objects are deselected.

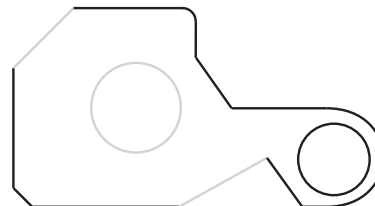

#### Tip:

Specify that only certain objects, layers, or colors are selected by setting a selection mask with the *Selection Mask* command. *Select All* is useful to make a global change in a drawing, such as changing the width of all lines.

## Tracer Tool



*Tip:*  
The **Tracer** tool is most useful for selecting boundaries for Crosshatching, Fills and for 2D Analysis because it eliminates the need to

This **Tracer** tool, in the first subpalette of the main tool palette, selects boundaries and uses coincident endpoints and line intersections to trace the perimeter of the geometry.

1. In the **Selection** tool subpalette, select the **Tracer** tool. The Message Line reads, *Tracer: Pick curve to start trace. [Shift = Extend]*.
2. Click on a boundary line.

The Tracer moves from one line to another making its selection.

With two overlapping objects as shown here, the **Tracer** tool selects the perimeter of the objects, depending on where the object is clicked.

Clicking on the outside of the perimeter line, the **Tracer** tool selects the outer most perimeter.

The crosshatching of the figures below shows the boundaries selected when clicking the **Tracer** tool at the cursor locations shown.

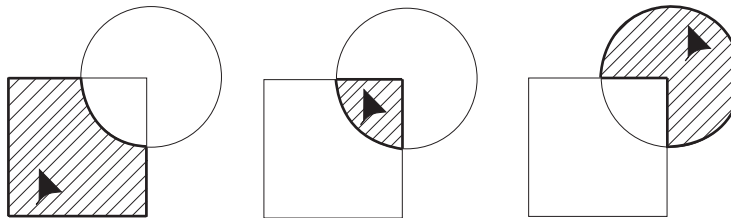
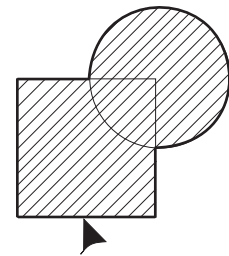

Clicking on the inside of the line, the tracer selects the inner most perimeter.

The **Tracer** tool does not select actual geometry, but rather creates temporary geometry that Graphite uses for operations like Fills, Crosshatching and 2D Analysis.

The **Tracer** tool does not work on a 3D model.

## Select by Polygon Tool



This tool, in the first subpalette of the main tool palette, selects one or more objects when a polygon is drawn around them. Each object must be completely enclosed by the selection polygon for the object to be selected. This tool functions similarly to the **Connected Lines** tool.

1. Choose the **Select by Polygon** tool in the **Selection** tool palette. The Message Line reads, *Select By Polygon: draw polyline [Shift = Extend]*.



2. Click or drag to indicate the endpoints of the line segments that will make up this selection polygon. The selection polygon appears as line segments in the designated selection color.

Press the ESC key or choose *Undo* to remove the last line. Pressing the BACKSPACE key (Windows) or the DELETE key (Macintosh) removes the entire selection polygon.

3. Indicate the last point by double-clicking or choosing another tool.

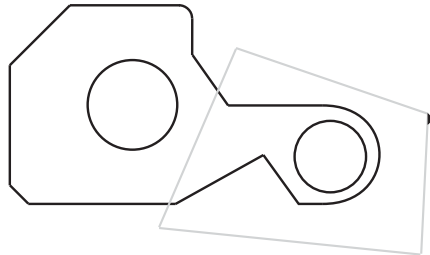

Completely enclose the object or objects to be selected. Objects not completely within the selection polygon are not selected. The graphic below shows the selected objects in gray.

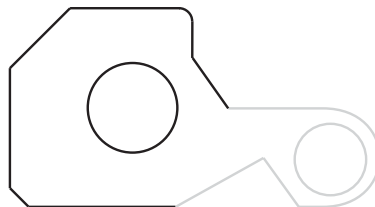

## Eye Dropper Tool



The Eyedropper tool copies properties from a selected entity to another entity, including lines, fonts, layers or dimensions. For text the properties include font, size and color. For dimensions it includes text location, font, size, style, colors, line weight, layers and arrow head on/off.

1. Select the **Eye Dropper tool** from the Selection tools palette. The Message Line reads, *Eye Dropper: Select objects to copy from [Shift=Extend]*.
2. Select or deselect multiple characteristics to be extracted for the Eye Dropper dialog box that automatically appears.

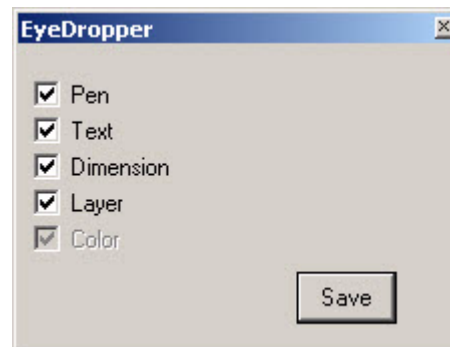

Click the Save button for the selections to be saved in Preferences and remembered each time the tool is selected.

3. Select the object with the characteristics to be copied.
4. Select the objects to receive characteristics. Apply the properties to multiple objects before clicking anywhere in open space to deactivate the tool.

Each object's characteristics change to those of the referenced object.

You can also select the object before you select the tool. If you do this, you only select the reference entity and the object automatically changes.

There are no Status Line entries.

## Deselecting

To deselect an object, click anywhere in the drawing area where there is no object, or click any of the creation tools in the tool palette.

To deselect an object that was selected in a multiple selection operation. Hold down the SHIFT key and click the objects to deselect.

## Selection Commands

Graphite provides various selection commands for selecting objects.

### *Select All*

CTRL+A (Windows); ⌘+A (Macintosh)

This command in the Edit menu selects all objects except those on a hidden layer or excluded by the Selection Mask. Double-click the **Selection** tool to select all objects. By choosing *Select All* while using the **Text** tool, all characters in the current text area are selected.

### *Selection Mask*

This command in the Edit menu limits selection by object type, layer and color. Only objects that are highlighted in the dialog box can be selected.

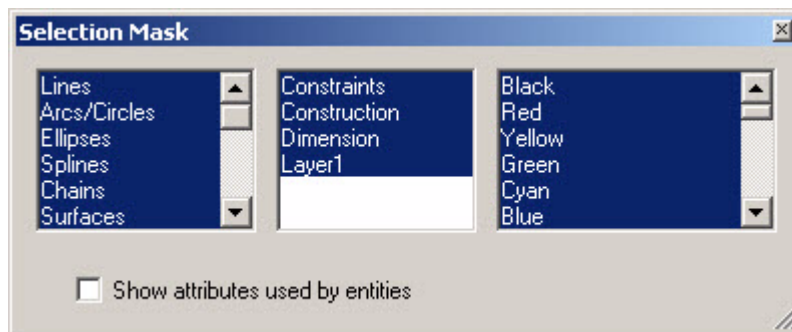

For example, if circles are not highlighted, when you choose *Select All* from the Edit menu, everything but the circles is selected. In this way, it is possible to select such combinations as only blue splines or only red objects on a particular layer.

#### *Tip:*

The *Selection Mask* is useful to change particular groups of objects in a complex drawing. Use this feature to export some but not all geometry. Also use the *Selection Mask* to change all dimensions from parametric variables to real values as described in the Chapter 16 “Parametrics.”

### Using the Selection Mask

1. Choose **Edit>Selection Mask**.

The Selection Mask dialog box appears.

The highlighted items respond to all selection methods and are detected by the Drafting Assistant.

2. Designate the items allowed to be selected so they are highlighted.

While the dialog box is visible, it is possible to select, create and edit geometry. Move the dialog box if it covers geometry. The Selection Mask remains in effect after closing the dialog box until a tool is selected.

When an item in the dialog box is not highlighted, the Drafting Assistant and all the tools cannot detect it, even though it is visible on the screen.

### Selecting or Deselecting Listed Items

- To select one item, simply click on the item and the rest of the list will be deselected.
- To deselect a list quickly, click one item in the list.
- To select a contiguous group of items, click on the item at the top or bottom of the desired group list, then hold down the SHIFT key and click or drag up or down to select the other items in the group.
- To select or deselect non-contiguous items, hold down the CTRL (Windows) or the ⌘ key (Macintosh) and click on the items.

The *Selection Mask* includes objects like lines, arcs/circles, text, etc. Most of the objects are self-explanatory except for those mentioned below.

#### **Chain**

This object is created when using *Flatten View* in the Views menu. For more information see Chapter 14 "Advanced Viewing Techniques."

## Selecting Points

Selecting points differs from selecting objects because points are not always visible.

Being able to select points is useful in two situations: stretching selected geometry (described later in this chapter) and control point selection for transformations.

When drawing a selection fence around objects, all geometry that is completely within the fence is selected. If geometry is partially within the fence, only the control points inside the fence are selected, and the geometry is not selected.

### Show Points

This command in the Layout menu toggles the display of the *control points* (endpoints, midpoints, center points, and knot points) for selected objects. When points are displayed, select a point by clicking it. If points are not displayed (but *Selectable Points* is set in the Edit menu), select a point by dragging a selection fence around the location of the point.

To show points for an individual selection, in the Edit menu, use the *Edit Objects* command.

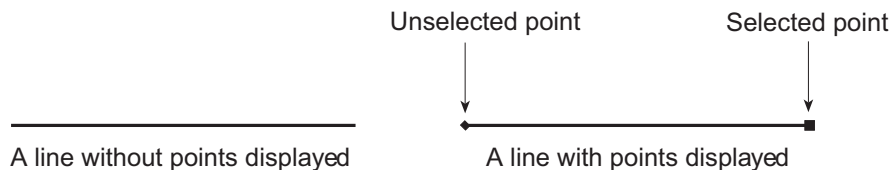

By selecting and dragging an entire line, the line and the endpoints move. By selecting and dragging only an endpoint of the line, the endpoint moves and the line length changes while the other endpoint of the line remains fixed.

### Displaying Points

1. Select the geometry.
2. Choose **Layout>Show/Hide Points** to toggle the display of points on and off.

To turn off the point display once the points of an object are showing, select the object again and choose either **Layout>Hide Points** or the *Control Points* option in the Edit Objects dialog box.

### Showing and Hiding Points with Stroke

When holding down the CTRL+SHIFT keys (Windows) or the Command (⌘) key (Macintosh) and clicking an object, the display of the object's points toggles on or off. If the points are hidden when clicking the object, the points are displayed.

### Selecting Points

A control point can be selected whether the points are visible or not, however, *Selectable Points* in the Edit menu must be on, displaying a check mark in the menu. To select points if points are not visible:

1. Click the **Selection** tool.
2. Drag a selection fence around the location of the point.  
The selected point displays as a square.



To select points if they are visible:

1. Click the **Selection** tool.
2. Click the point.  
The selected point displays as a square.



### Selectable Points

This command in the Edit menu selects points that aren't displayed. When *Selectable Points* are not set, selecting points by dragging a fence is not possible. If points are displayed, simply click the point to select it. If points are not displayed, select a point by dragging a selection fence around it. The following example illustrates the use of *Selectable Points*.

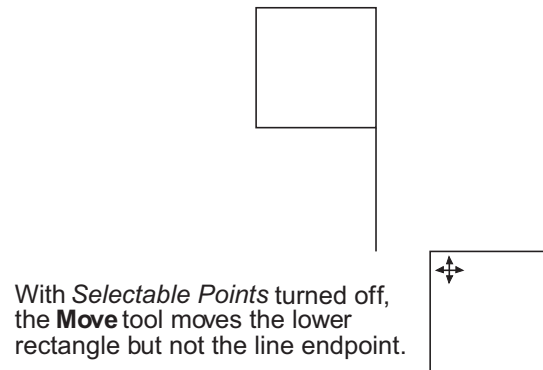
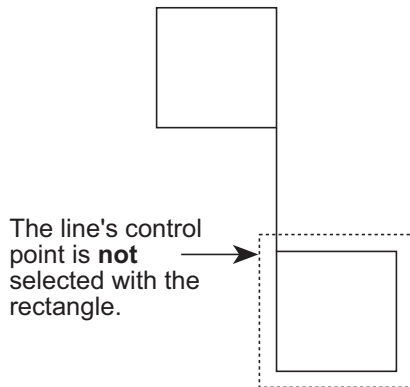
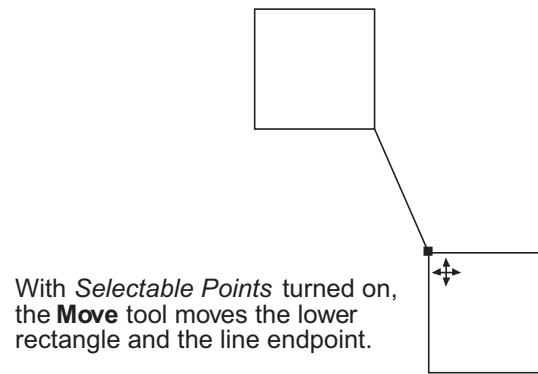
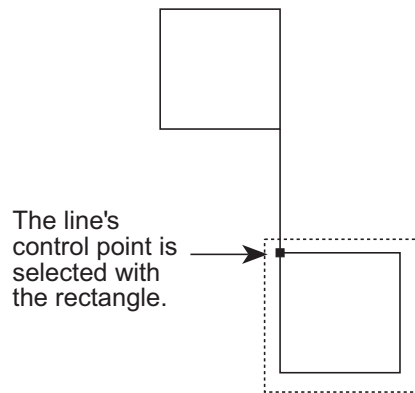



# Editing Objects

Once an object is created, alter it by selecting it and choosing a command or a tool to edit it. This chapter describes the common editing activities to perform on a selected object and compares different methods for performing the same action.

The specific topics covered are:

- Editing Tools
- Moving Objects with Tools
- Copying Objects with Tools
- Sizing Objects with Tools
- Editing Commands
- Erasing Geometry
- Changing the Characteristics of Objects
- Arranging Geometry

## Editing Tools

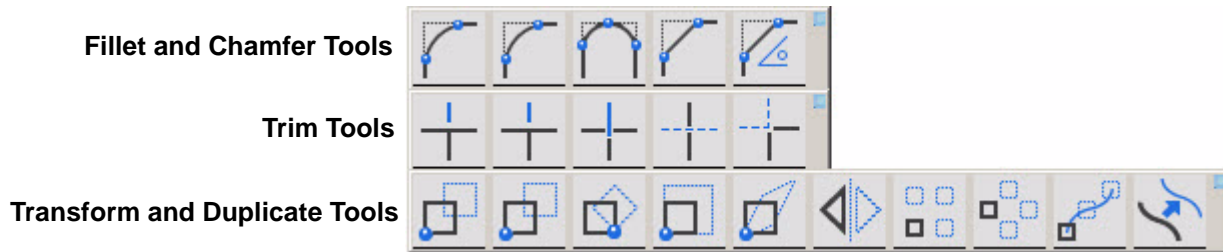

These tools are used to change an object physically, either by altering the geometry, changing the size, changing the location, or modifying orientation of the selected object. Three subpalettes on the tool palette provide these editing capabilities.

### Fillet and Chamfer

The **Fillet** tools round the corners of non-parallel lines. The **Chamfer** tools cut them at straight angles.

### Trim

The **Trim** tools cut off or extend a line to the boundary limit specified. They also segment a line at an intersection, and create corners from intersecting lines.

### Transform and Duplicate

The **Transform** tools move, rotate, expand or shrink, and mirror objects. The **Duplicate** tools copy and arrange objects in particular patterns.

## Fillet and Chamfer Tools

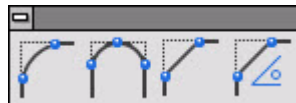

These tools construct fillets and chamfers from corners formed by nonparallel lines or curves. The fillets and chamfers are automatically trimmed, unless the CTRL (Windows) or the OPTION (Macintosh) key is held down while selecting the objects.

### 2-Entity Fillet Tool



The **2-Entity Fillet** tool constructs an arc tangent to the two objects clicked. Fillets use the smallest arc between the selected geometry.

### Using the 2-Entity Fillet Tool

1. Click the **2-Entity Fillet** tool. The Message Line reads, *2-Entity Fillet: Pick first entity [Shift = Corner, Ctrl = No trim (Windows) or Option = No trim (Macintosh)].* The Message Line guides each successive step.
2. Enter the arc radius in the Status Line. The default radius is .25 inch.
3. Select the first entity.
4. Select the second entity. The fillet is created.

Another method is to hold down the SHIFT key and click once inside the desired corner to be filleted. By holding down the CTRL (Windows) or OPTION (Macintosh) key while selecting the objects to fillet, the objects are not trimmed. These options are noted in the Message Line.

The Status Line specifies the Radius of the fillet either before or after creating the fillet.

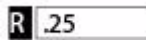

### 3-Entity Fillet Tool



The **3-Entity Fillet** tool constructs a fillet tangent to the three objects chosen.

### Using the 3-Entity Fillet Tool

1. Click the **3-Entity Fillet** tool. The Message Line reads, *3-Entity Fillet: Pick first entity [Ctrl = No trim (Windows) or Option = No trim (Macintosh)].* The Message Line guides each successive step.
2. Click the three objects to fillet.

By holding down the CTRL (Windows) or OPTION (Macintosh) key while selecting the objects to fillet, the objects are not trimmed.

There are no Status Line entries.

## 2-Entity Chamfer Tool



The **2-Entity Chamfer** tool creates a chamfer across a corner at the specified distance from the intersection of two lines.

### Using the 2-Entity Chamfer Tool

1. Click the **2-Entity Chamfer** tool. The Message Line reads, *2-Entity Chamfer: Pick first entity chamfer [Shift = Corner, Ctrl = No trim (Windows) or Option = No trim (Macintosh)].* The Message Line guides each successive step.
2. In the Status Line, enter the distance of the chamfer from the corner. (The default distance is .25 inch.)
3. Click each line making up the corner to be chamfered. Another way is to hold down the SHIFT key and click once inside the corner to chamfer.

The lines are automatically trimmed or extended, unless the CTRL (Windows) or the OPTION (Macintosh) key is held down while selecting the objects.

These options are noted in the Message Line.

The Status Line specifies the distance (length) from the chamfer to the intersection of the corner lines.

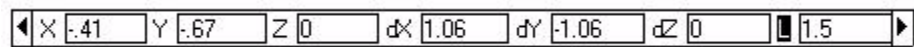

## Angular Chamfer



The **Angular Chamfer** tool creates a chamfer at the specified angle and distance from the corner. The specified angle is that between the chamfer and the second line of the corner. The specified length is the distance between the *corner and the intersection of the chamfer and the second line of the corner.* (The *second line of the corner* refers to the second line chosen when creating the chamfer).

### Using the Angular Chamfer

1. Click the **Angular Chamfer** tool. The Message Line reads, *Angular Chamfer: Pick first entity to chamfer [Ctrl = No trim (Windows) or Option = No trim (Macintosh)].* The Message Line guides each successive step.
2. In the Status Line, enter the length of the intersection of the chamfer and the second line of the corner from the corner. The default length is .25 inch.
3. Enter the angle between the chamfer and the second side. The default is 45°.
4. Click each line making up the corner to be chamfered.

The lines are automatically trimmed or extended, unless the CTRL (Windows) or the OPTION (Macintosh) key is held down while selecting the objects.

The Status Line sets the distance (length) from the intersection as well as the angle.

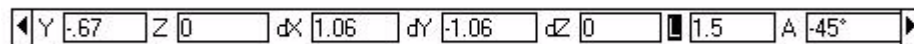

### Trim Tools



The **Trim** tools on the tool palette lengthen or shorten lines and curves. In general, select the limiting object(s) before selecting the tool. If you forget to select everything needed, however, hold down the SHIFT key and the Trim tool temporarily becomes the **Selection** tool so that additional objects can be selected.

#### Simple Trim Tool



The **Simple Trim** tool shortens a line to the specified boundary. By holding down the CTRL (Windows) or the OPTION (Macintosh) key while using this tool, it becomes the **Relimit** tool.

**Rule:** Point to what is to be removed.

### Using the Simple Trim Tool

1. Select the object that limits the trim.
2. Select the **Trim** tool. The Message Line reads, *Simple Trim: Pick section to trim [Shift = Select boundary, Ctrl = Relimit (Windows) or Option = Relimit (Macintosh)].*

If necessary, use SHIFT-Click to select more boundary objects.

3. Click the section of the object to be discarded.

There are no Status Line entries.

### Relimit Tool



This tool lengthens or shortens a line to the specified boundary. By holding down the CTRL (Windows) or the OPTION (Macintosh) key while using this tool, it becomes the **Trim** tool.

**Rule:** Point to what is to be kept.

### Using the Relimit Tool

1. Select the object that limits the change.
2. Select the **Relimit** tool. The Message Line reads, *Relimit: Pick section to retain [Shift = Select boundary, Ctrl = Trim (Windows) or Option = Trim (Macintosh)].*

If necessary, use SHIFT-Click to select more boundary objects.

3. Click the section of the object to remain.

There are no Status Line entries.

### Segment Tool



The **Segment** tool divides a line or curve at intersections with other lines or curves.



### Using the Segment Tool

1. Select the objects that limit the segmentation.
2. Select the **Segment** tool. The Message Line reads, *Segment: Pick entity [Shift = Select boundary, Ctrl = Current pen (Windows) or Option = Current pen (Macintosh)]*.

If necessary, use SHIFT-Click to select more boundary objects.

3. Click the object to be segmented.

The selected object segments at the boundary objects. Even though the segmentation cannot be seen on the screen, parts of the segmented line may be selected by clicking.

There are no Status Line entries.

In order to see the segmentation on the screen, first select the boundaries and the object to segment and then choose **Layout>Show Points**. After the segmentation, the endpoints of the segmented parts are displayed.

By holding down the CTRL (Windows) or OPTION (Macintosh) key while selecting the line to be segmented, the new segment appears in the characteristics of the current pen style.

### Corner Trim Tool



The **Corner Trim** tool creates a corner from two specified objects. Lines are extended or shortened to create the corner.

### Using the Corner Trim Tool

1. Click the **Corner Trim** tool. The Message Line reads, *Corner Trim: Pick first entity to trim [Shift = Corner, Ctrl = No Trim (Windows) or Option = No Trim (Macintosh)]*. The Message Line guides each successive step.
2. Click each object.

Another way is to press and hold the SHIFT key and click inside the about-to-be-created corner.

There are no Status Line entries.

### Extending Lines to a Theoretical Intersection

To extend a line to its theoretical intersection with another line, first click the line to be extended, then hold down the CTRL (Windows) or OPTION (Macintosh) key and click the line that is not to be trimmed.

## Transformation Tools

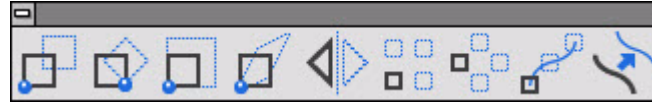

The first part of the **Transform & Duplicate** palette has the **Transformation** tools. These tools move, rotate, expand or shrink, stretch, vector-defined and mirror objects. Select the object to transform before selecting a Transformation tool.

It is possible to copy while transforming objects by holding down the CTRL (Windows) or the OPTION (Macintosh) key while specifying the transformation.

By pressing the SHIFT key, additional objects may be selected after Transformation tool is chosen, the tool temporarily becomes the **Selection** tool so that as soon as the SHIFT key is released the Transformation tool is active again.

### Move Tool



The **Move** tool relocates the selected objects in a new position. Copy the selection by holding down the CTRL (Windows) or OPTION (Macintosh) key while selecting the objects. Select more than one object and they remain in the same position relative to each other.

#### Referral:

Enlarging or shrinking an object with the **Move** tool is described under “Sizing Objects with Tools” in this chapter.

#### Tip:

Geometry can be nudged a specified distance within Graphite using the arrow keys on the keyboard. More information on nudging geometry is available further ahead in this chapter.

### Using the Move Tool

1. Select the object(s) to be moved.
2. Select the **Move** tool. The Message Line reads, *Move: Pick beginning reference point [Shift = Select, Ctrl = Copy (Windows) or Option = Copy (Macintosh)].*  
If necessary, use SHIFT-Click to select more objects.
3. Drag the selected object to a new location, clicking to set a reference point, and releasing to indicate the new location.

Another way is to click a reference point, then click a destination point to move the selected object to the new location. It is not necessary for the reference and destination points to be on the object being moved. The move is performed relative to the specified points.

The Status Line specifies the distance for the selection is to be moved in a particular direction.



A positive or negative value entered in a data field of the Status Line determines the direction along the axis. A negative value moves the object to the left or down on the screen. A positive value to the right or up.

## Rotate Tool



The **Rotate** tool rotates one or more objects around a specified point. Copy the selection by holding down the CTRL (Windows) or OPTION (Macintosh) key while selecting the objects. When selecting more than one object, they remain in the same position relative to each other.

Keep in mind that objects are always rotated about the Z-axis with this tool.

### Using the Rotate Tool

1. Select the object(s) to be rotated.
2. Select the **Rotate** tool. The Message Line reads, *Rotate: Pick center of rotation [Shift = Select, Ctrl = Copy (Windows) or Option = Copy (Macintosh)].*  
If necessary, use SHIFT-Click to select more objects.
3. Select the center of rotation.
4. Drag the objects or enter an Angle in the Status Line to specify the rotation.

The Status Line specifies the angle of rotation.

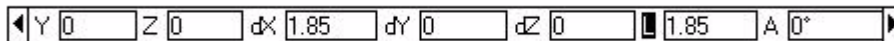

Another way is to click the reference point and then click the destination point. It is not necessary for the reference and destination points to be on the object being moved. If they are not, the rotation is performed relative to the specified points.

This tool rotates the selected geometry around an axis through the origin specified and parallel to the z-axis of the work plane. The *Object Rotation* command rotates around any axis specified.

## Expand/Shrink Tool



The **Expand/Shrink** tool resizes objects while maintaining the proportions. Copy the selection by holding the CTRL (Windows) or OPTION (Macintosh) key when selecting the objects. If more than one object is selected, they remain in the same position relative to each other.

### Tip:

Using the beginning and ending reference point for the **Expand/Shrink** tool is particularly useful to change the size of an object relative to the size of another object.

### Using the Expand/Shrink Tool

1. Select the object(s) to be expanded or shrunk.
2. Select the **Expand/Shrink** tool. The Message Line reads, *Expand/Shrink: Pick anchor point [Shift = Select, Ctrl = Copy (Windows) or Option = Copy (Macintosh)].* The message Line guides each successive step.

If necessary, use SHIFT-Click to select more objects.

3. Click a point on the object to remain stationary.
4. Click the beginning reference point.
5. Click the ending reference point.

The object changes size so the beginning reference point meets the ending reference point.

The Status Line specifies the exact scale (Factor).



To expand or shrink geometry in one direction only, use the **Stretch** tool below.

### Stretch Tool



The **Stretch** tool resizes the geometry along one axis and at a specified angle. If more than one object is selected, they remain in the same position relative to each other.

### Using the Stretch Tool

1. Select the object(s) to be stretched.
2. Select the **Stretch** tool. The Message Line reads, *Click point to remain fixed.*
3. Click the point to remain fixed.
4. Click the beginning reference point to define the angle.
5. Click the ending reference point to define the scale.

The object resizes along one axis at a specified angle. The Status Line shows the exact scale (Factor) and Angle.

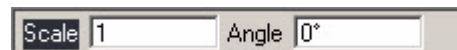

## Mirror Tool



The **Mirror** tool creates the mirror image of an object or objects on the opposite side of a reference line. Copy the selection by holding down the CTRL (Windows) or OPTION (Macintosh) key while selecting the objects. If more than one object is selected, they remain in the same position relative to each other.

### Using the Mirror Tool

1. Select the object(s) to be mirrored.
2. Select the **Mirror** tool. The Message Line reads, *Mirror: Pick beginning of reference line [Shift = Select, Ctrl = Copy (Windows) or Option = Copy (Macintosh)].*

If necessary, use SHIFT-Click to select more objects.

3. Specify the reference line by clicking two locations or by dragging. The reference line needs not be parallel to the object.

Hold down the CTRL (Windows) or OPTION (Macintosh) key, before specifying the reference line to create a mirrored copy.

The Status Line has no entries.

**Note:** When working in 3D, mirror selected geometry through the axis specified and parallel to the work plane.

## Duplication Tools



The second part of the **Transform & Duplicate** palette has the **Duplication** tools. Using Graphite multiple copies of an object can be created and arranged in an array along a straight line, in a circular pattern or copied by path. They can also be offset.

If a duplication is not satisfactory, stop the process by pressing the ESC key, and then use *Undo* to remove the copies from the document.

### Linear Duplicate Tool



The **Linear Duplicate** tool creates an array of copies along a straight line. In addition to the **Transform & Duplicate** palette, this command is also accessed from the Edit menu.

Select the command and the dialog box appears:

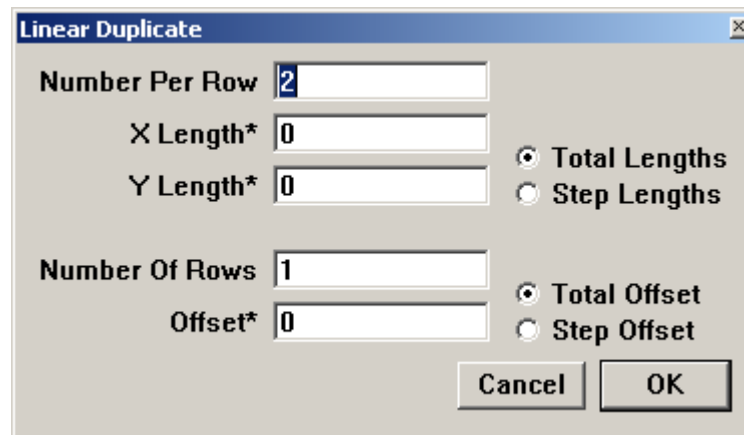

The Linear Duplicate dialog box contains the following settings:

#### Number Per Row

This is the total number of objects in each row. Be sure to include the selected object itself in this total count.

If the number is unknown use math operators to determine the number of copies. For example, to place studs 16 inches apart on a 17 foot wall, enter  $(17 \times 12) / 16$ . Graphite truncates the result to create 12 copies.

<b>X Length/Y Length</b>	<p>The X Length value determines the horizontal length of a row. The Y Length value determines the vertical rise of the row.</p> <p>The X Length and Y Length can be set by entering values, or by clicking the mouse in the drawing area.</p>
<b>Total Lengths</b>	<p>The Total Lengths is the distance from the selected object to the last copy.</p>
<b>Step Lengths</b>	<p>The Step Lengths is the distance from the selected object to the first copy.</p>
<b>Number of Rows</b>	<p>This designates the total Number of Rows.</p>
<b>Total Offset</b>	<p>The Total Offset is the perpendicular distance between the row containing the selected object and the last row.</p>
<b>Step Offset</b>	<p>The Step Offset is the perpendicular distance between the row containing the selected object and the next row.</p>
<b>Offset</b>	<p>This is the perpendicular distance setting for the Total Offset or Step Offset.</p> <p>Specify the Offset by entering a value or by pressing and dragging the mouse in the drawing area.</p>

### Using the Linear Duplicate Tool

1. Select the object to be duplicated.
2. Choose **Edit>Linear Duplicate** or choose the tool from the **Transform and Duplicate** palette.

A dialog box appears.

An asterisk (\*) appearing beside an entry field indicates that the field can be filled by dragging the mouse in the drawing area to indicate the length. This is a very handy and accurate way to specify this information.

3. Enter the *Number of objects Per Row*.
4. Specify *Total* or *Step Lengths* by clicking a button.
5. Click the *X Length\** data field.
6. Move the pointer to the drawing area and drag to indicate the length of the row of copies.

Both the X and Y values appear in the data fields.

7. If more than one row is desired, enter the *Number of Rows*, and click a button to specify the type of offset.
8. Enter the offset, if any. A negative number can be used.  
Dragging to indicate the offset is particularly useful to equal the distance between two objects.
9. Click OK.



### An Example

Suppose it is necessary to illustrate six machine screws. Draw the geometry, then use *Linear Duplicate* to copy the geometry in an array.

1. Create and select the geometry to duplicate.
2. Choose **Edit>Linear Duplicate** or choose the tool from the **Transform and Duplicate** palette.
3. Enter **6** in the *Number Per Row* data field.
4. Click the *Step Length* option.
5. Click in the *X Length* data field.
6. Move the pointer into the drawing area and drag across the widest point of the step.
7. Click at the end of the entry in the *X Length* data field.
8. Type **\*2** to multiply the width of the geometry by two.
9. Click OK.

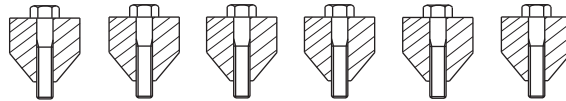
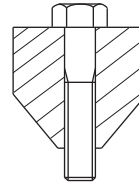

The geometry duplicates in a linear array.

### Polar Duplicate Tool



The Polar Duplicate command copies and rotates the selected geometry. When duplicating an object in a circular array, specify the number of duplications, the center of the array and whether the objects are copied in a rotated orientation or an upright orientation. In addition to the **Transform & Duplicate** palette, this tool is also accessed from the Edit menu.

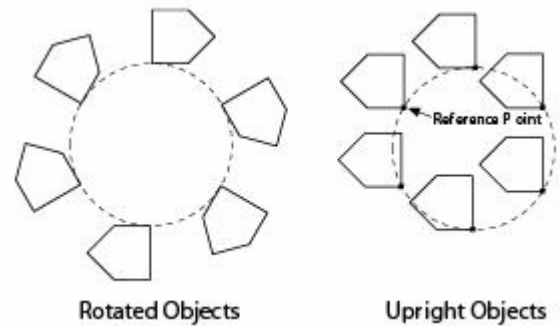

#### Referral:

For more information about using the Copy command in the Edit menu, see the section Editing Commands later in this chapter.

Select this tool and the dialog box appears.

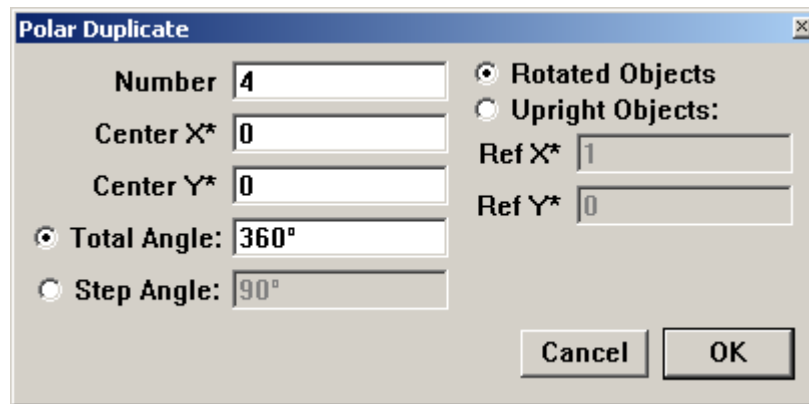

The Polar Duplicate dialog box contains the following settings:

#### Number

This is the total number of objects to be duplicated. Be sure to include the selected object itself in this total count.

#### Center X/Center Y

The Center X and Y values determine the center of the circular array.

The Center X and Center Y can be set by entering values, or by clicking the mouse in the drawing area.

<b>Total Angle</b>	The Total Angle is the number of degrees between the center of the selected object and the center of the last copy.
<b>Step Angle</b>	The Step Angle is the number of degrees between the center of the selected object and the center of the first copy.
<b>Rotated Objects</b>	Copies are rotated relative to the angle between the copies. Each single arbitrary point of all copies have the same distance to the center of the circular array. That means that any point of the object can be the reference point.
<b>Upright Objects</b>	Copies are upright with respect to the selected object. This option requires a reference point.
<b>Ref X/Ref Y</b>	<p>This is the reference point for the Upright Objects option.</p> <p>Ref X and Ref Y determine an imaginary point duplicated around the center, as specified. The selected objects are reproduced in the same position relative to each imaginary point that is duplicated. With the Rotated Objects option the reference point has a constant distance to the center of the circular array. Specify the Ref X and Ref Y by entering a value or by clicking the mouse in the drawing area.</p>

### Using the Polar Duplicate Tool

1. Select the object to be duplicated.
  2. Choose **Edit>Polar Duplicate** or choose the tool from the **Transformation** palette  
A dialog box appears.  
An asterisk (\*) beside an entry field indicates that the data can be filled in the field by dragging the mouse in the drawing area to indicate the length. This is a very handy and accurate way to specify this information.
  3. Enter the *Number* of objects in the circular array.
  4. Click the *Center X\** data field.
  5. Move the pointer to the drawing area and click to indicate the center for the array of copies.  
The values for *Center X* and *Center Y* appear in the data fields.
  6. Specify *Upright* or *Rotated* objects by clicking a button. See the next section for the definition of these terms.
  7. If *Upright* is specified, click a location for the reference point in the drawing area.
  8. If the copies do not need to be in a complete circle, click the *Total* or *Step Angle* option.
  9. Enter a value for the specified angle type.
  10. Click OK.
- To place a selected object three times in a semi-circle, enter 3 for the Number and 90° for the Step Angle.

## Copy by Path Tool



The **Copy by Path** tool creates an array of copies along a curve. After selecting the object, anchor point and the path, the dialog box appears.

The Copy Along Path dialog box contains the following settings:

<b>Number</b>	The total number of objects that should be after copying by path.
<b>Step</b>	The distance from the selected object to the first copy.
<b>Fill the path with step</b>	
<b>First to second</b>	Sets the distance between first and second point by step.
<b>First to last</b>	Sets the distance between first and last point by step.
<b>Reverse direction</b>	Reverses the direction of array.
<b>Turn to normal</b>	Turns to normal of copy.

<b>Another side</b>	This option allow to reside of copy.
<b>Cut in path's end</b>	This option allow to cut the number of copies on the circle.
<b>Anchor point X*/Y*</b>	The values determine place of anchor point.
<b>Complete set</b>	Allow to finish working with current array and start new array.

### ***Using the Copy by Path Tool***

1. Choose the tool from **Transformation** palette.
2. Select the object to be duplicated.
3. Pick the anchor point.
4. Select the path (line, spline, circle...). Use SHIFT to choose several objects (rectangle, several splines...)
5. A dialog box appears.
6. Enter the Number of objects in the array.
7. Enter the Step.
8. Pick on the path to set start point.
9. Click the Complete set to continue working with this tool and start new array.

## Offset Tool



The Offset command creates offsets from lines, arcs, circles, ellipses and splines. In addition to the **Transform & Duplicate** palette, this is also accessed through the Edit menu.

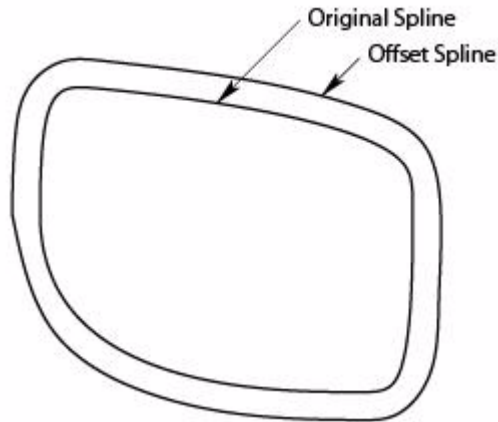

When selecting this command, the Offset dialog box appears.

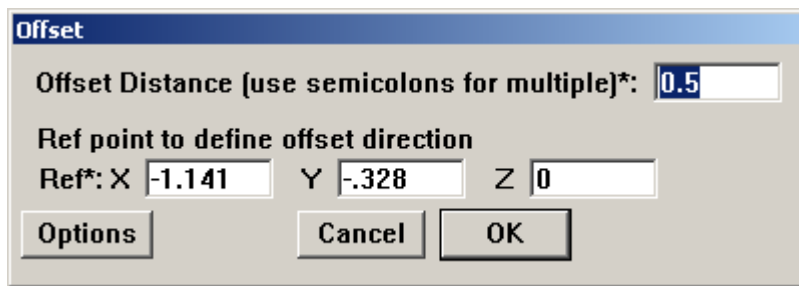

The dialog box contains the following settings:

### **Offset Distance\***

This is the distance away from the original geometry that the new geometry is created. The asterisk indicates that the cursor can be used to input an offset distance by dragging between any two points on the drawing area. The cursor must be in the *Offset Distance* field while dragging. For

multiple offsets additional values may be entered manually, separated by semicolons.

The X, Y, or Z direction values can be filled in manually or indicated by a mouse click on the drawing area offset from the object. The point clicked determines which side of the object the offset should be performed. The offset direction (positive or negative value) is also filled in the respective entry fields when dragging the offset distance since the vector dragged determines the Offset direction automatically.

Clicking the Options button displays this dialog box.

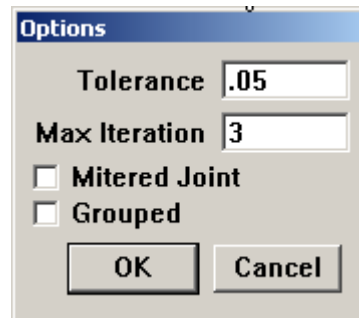

The Options dialog box contains the following settings:

**Tolerance**

For spline and ellipse objects the offset distance is approximated by a spline. Setting a *Tolerance* for this type of object determines how accurate the offset is relative to its theoretical position.

**Max Iteration**

Graphite iterates the number of times specified when calculating the offset of spline and ellipse objects to improve the approximation. The default value is 3. Setting a high value (100, 1000, etc.) decreases performance.



**Mitered Joint**

If this option is marked, the offset object has square external corners instead of filleted corners. This option is, by default, not selected. The radius of the filleted corners is automatically set to the offset distance. For instance, a box that is offset by .25 has a fillet at each corner with a radius of .25.

**Grouped**

If this option is marked, the new offset geometry is grouped when created. This option is, by default, not selected to produce ungrouped geometry.

***Creating an Offset***

1. Select the object to offset.
2. Choose **Edit>Offset** or choose the tool from the **Transform and Duplicate** tool palette.  
The Offset dialog box displays.
3. Click into the *Offset Distance\** field.
4. Input an offset distance by dragging between any two points on the drawing area.
5. Click in one of the *Ref\** entry fields.
6. Enter an offset direction by dragging between any two points on the drawing area.
7. Click the Options button.

In the Options dialog box, specify a *Tolerance*, if needed, and whether or not the object will be offset with mitered corners.

The new geometry ungroups, and the original geometry remains selected.

For Graphite, if an offset is created with the work plane not set to match the plane of the object being offset, the results may be unpredictable. The *Z\** value is ignored in the Offset dialog box, and the distance is applied in the plane of the object being offset.

## Moving Objects

When an object is selected, move the pointer near the object until the 4-way Move symbol appears as shown below, and drag the object to a new location.



**Note:** If there is difficulty displaying the 4-way Move symbol, it might be because the *Paste* command was just used. When an object is drawn and then immediately copied and pasted, the original drawing tool is still in effect. Click the **Selection** tool to access the 4-way Move tool when the cursor is moved near an object.

### Using the Drafting Assistant for Moving

When the pointer becomes the 4-way Move symbol, drag the object around to see the Drafting Assistant's notations relative to the object's location. If the pointer is moved over a control point activated by the Drafting Assistant the object can be aligned using that point.

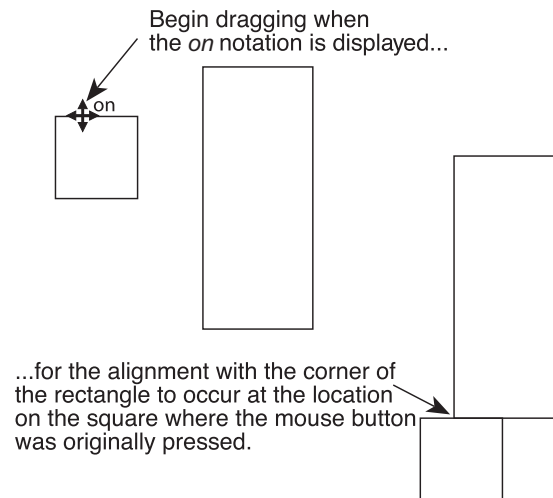

## Selected Move versus Move Tool

Objects can be moved using either with the **Selection** tool or the **Move** tool, or nudged with the arrow keys.

### *Moving with the Selection Tool*



The move tool of the **Selection** palette freely moves a selected object.

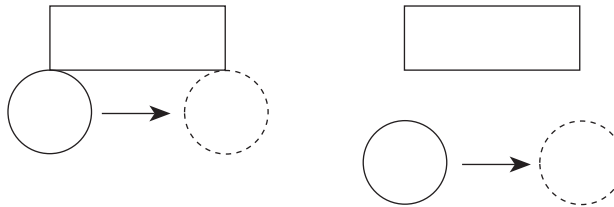

To move a circle from one location to another as shown above, use the **Selection** tool and the Drafting Assistant to align the 90° *quadrant* with the corner of the rectangle. The circles do not need to touch the rectangle to be aligned with it.

To move a circle or an arc from its center point, use the **Move** tool rather than the **Selection** tool.

### *Nudging Geometry*

Geometry can be nudged a specified distance within Graphite using the arrow keys on the keyboard.

#### **Setting the Nudge Distance**

1. Go to **Layout>Preferences>Nudge** or Right Mouse Click and choose **Nudge**.

#### **Moving with Nudge**

1. Select an item or items to move or Nudge.
2. Use the arrow keys to move the selected items in the desired direction. By holding down the CONTROL key the nudge distance is doubled.

## Moving with the Move Tool



The **Move** tool relocates the selection with reference to other geometry.

Move a 1-inch square 2 inches in the X direction and 1 inch in the Y direction. See the following graphic.

1. Select the square to be moved.
2. Select the **Move** tool.
3. Click one corner of the square when the *endpoint* notation displays.
4. Enter **2** in the X data field on the Status Line and **-1** in the Y data field.

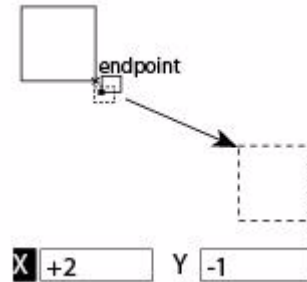

A positive or negative value entered in the Status

Line determines the direction along the X or Y axis. A negative value moves the object to the left or down on the screen, and a positive value moves the object to the right or up.

5. Press the ENTER (Windows) or RETURN (Macintosh) key.  
The square moves.

### Tip:

Use the **Move** tool to move a circle or an arc by its center point. The **Selection** tool cannot do this.

## Moving Objects to Another Layer

1. Select the object(s) to move to another layer.
2. Choose **Edit>Edit Objects**.
3. In the Layer field of the Edit Objects dialog box select to the desired layer.
4. Click OK. The object is now located on the new layer.

## Copying Objects

Copy selections with the *Copy* command or by holding down the CTRL (Windows) or OPTION (Macintosh) key while using the following tools:

- **Selection** tool
- **Single Line** tool
- **Center-Point** and **Opposite-Point Circle** tools
- **Ellipse** tools
- **Polygon** tools
- **Text** tool
- **Transformation** tools

### Copying with the Selection Tool

Hold down the CTRL (Windows) or OPTION (Macintosh) key and drag a copy of the selection to a new location.

1. Click the **Selection** tool.
2. Select the object(s) to copy.
3. Hold down the CTRL (Windows) or OPTION (Macintosh) key.
4. Drag a copy of the selection to a new location.
5. Release the CTRL (Windows) or OPTION (Macintosh) key.

## Copying with the Geometry Tools

Make copies with the following drawing tools:

- **Single Line** tool
  - **Center-Point** and **Opposite-Point Circle** tools
  - **Ellipse** tools
  - **Polygon** tools
  - **Text** tool
1. Construct the geometry to copy.
  2. With the drawing tool still activated, hold down the CTRL (Windows) or OPTION (Macintosh) key.
  3. Click a new location. The click determines the location of the first point original geometry construction (the *center* of a center-point circle, for example).
  4. Release the CTRL (Windows) or OPTION (Macintosh) key.

## Copying with the Transformation Tools

Hold down the CTRL (Windows) or OPTION (Macintosh) key while using a Transformation tool to make a copy of the selected geometry.

1. Select the object to copy and transform.
2. Select one of the four **Transformation** tools.
3. Hold down the CTRL (Windows) or OPTION (Macintosh) key.
4. Perform the transformation according to the directions in the Message Line.
5. Release the CTRL (Windows) or OPTION (Macintosh) key.  
A copy transforms and the original remains unchanged.

## Copy Command versus CTRL (Windows) or OPTION (Macintosh)

Usually, using the copy option of a geometry tool is faster than using the *Copy* and *Paste* commands in the Edit menu. The *Copy* command is very useful for copying to a different document or application.

## Sizing Objects with Tools

Normally an object is sized with the **Selection** tool or the **Expand/Shrink** tool. In some cases it is possible to use the **Move** tool for sizing objects. Stretch objects by selecting a point and dragging it to a new location.

*Referral:*

Sizing with the **Expand/Shrink** tool is described in an earlier section.

### Sizing an Object with the Selection Tool

Stretch objects by selecting a point and dragging it to a new location.

1. In the Edit menu, be certain that *Selectable Points* is checked.
2. Click the **Selection** tool.
3. Drag a selection fence around the control points that represent the area to stretch.
4. Drag the points to a new location.

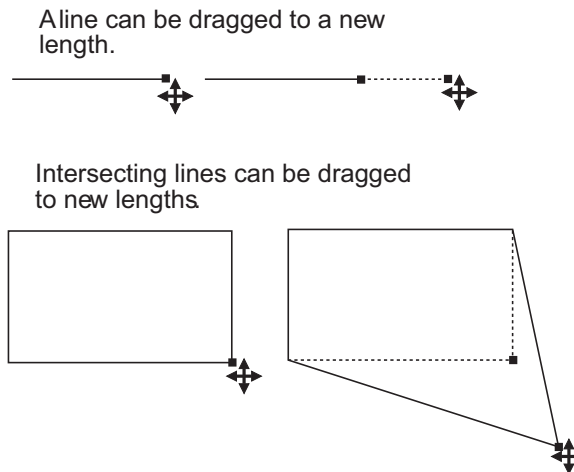

## Sizing an Object with the Move Tool

Size an object with the **Move** tool. Using the **Move** tool allows the distance that selected point(s) should be moved to be specified by particular values along the X and Y direction in the Status Line.

To move the corner of the rectangle in the next graphic with the **Move** tool:

1. In the Edit menu, be certain that *Selectable Points* is checked.
2. Click the **Selection** tool.
3. Drag a selection fence around the lower right corner of the rectangle, selecting only the point.
4. Click the **Move** tool.
5. Enter **+1** in the X data field and **-1** in the Y data field in the Status Line.
6. Press ENTER (Windows) or RETURN (Macintosh).

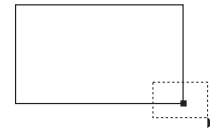

The corner of the rectangle moves the distance specified in the Status Line.

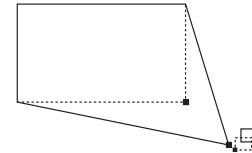

Use the **Move** tool for sizing objects only once since the next values entered in the Status Line do not refer to the new position of the moved point(s), but always to the original one. That means if (in our example) **-1** is entered in the X data field and **+1** in the Y data field, the point is not moved back to its original position, but in the opposite direction referring to its original position.



## Selected Sizing Versus Expand/Shrink Tool

Dragging a control point of a selected object changes the size of the object, but it also distorts the object, changing the proportion between height and width.

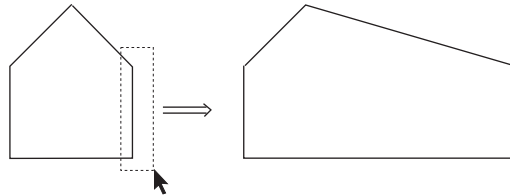

The **Expand/Shrink** tool on the Transformation subpalette resizes geometry while maintaining its proportions.

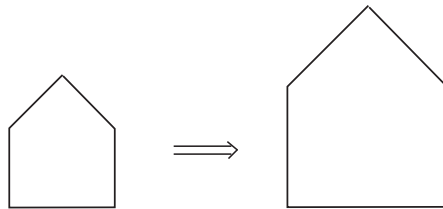

Use the **Expand/Shrink** tool to enlarge or shrink a shape proportionally

In addition, specify proportions by clicking points on other geometry. For example, resize an object to fit within another object by clicking the boundary into which the resized object must fit.

## Editing Commands

Commands in the Edit menu select and manipulate objects. Two important commands in this menu are *Undo* and *Redo* which reverse an action or reinstate it. Four other commands in the Edit menu change objects without changing the physical geometry. Using them it is possible to copy or move objects within the same document, either on the same sheet or to other sheets. They are also used to copy or move objects to other documents, even to other applications.

### *Tech Note:*

The difference between the *Cut* and *Copy* commands is that cutting a selection removes it from the drawing area while a copied selection remains in the drawing area.

The *Cut*, *Copy* and *Paste* commands do not alter the object's attributes, such as the layer and pen style (color, weight, and pattern). To change the attributes of an object, choose **Edit>Edit Objects**. The Cut and Copy commands place a copy of the selected object on the Clipboard. The Clipboard is a buffer, a temporary storage place that holds the last cut or copied selection. The contents of the Clipboard are objects, not bitmaps or pict.

### Cut

CTRL+X (Windows); ⌘+X (Macintosh)

The Cut command in the Edit menu removes the selected objects and places them on the Clipboard. Each selection cut or copied to the Clipboard replaces the previous Clipboard contents.

### Cutting Objects

1. Select the object to be cut.
2. Choose **Edit>Cut**.

Once a selection is cut, it can be pasted. Use *Cut* and *Paste* to move geometry or text around the document, from one sheet to another, or from one document to another. Paste the cut selection onto a document in a different application.

### Moving Geometry with the Cut Command

1. Select the objects to move.
2. Choose **Edit>Cut**.
3. Display the location for the selection to appear in the drawing area, scrolling if necessary.
4. Choose **Edit>Paste**.

The object appears in the center of the drawing area on the original layer on which it was created or onto the work layer if it's from a different application. The object is selected so it can be moved.

### *Tip:*

To move an object from one layer to another, choose the **Edit>Edit Objects**.

## Copy

CTRL+C (Windows); ⌘+C (Macintosh)

This command in the Edit menu places a copy of the selection onto the Clipboard without deleting the original selection. Paste the copy elsewhere in the current document or into a different document. Or even paste the copied selection into a document created with a different application.

### Copying Objects

1. Select the objects to be copied.
2. Choose **Edit>Copy**.

The selection goes on the Clipboard, and it remains in the current document.

## Paste

CTRL+V (Windows); ⌘+V (Macintosh)

The Paste command in the Edit menu pastes a copy of the Clipboard contents onto the center of the drawing area. The Clipboard contents are not changed when using the *Paste* command.

It is also possible to paste the selection into another Graphite document or into a document created with another application. To create an even distribution of geometry, in the Edit menu, use *Linear Duplicate* or *Polar Duplicate*.

### Rules:

1. If the object was cut or copied from a Graphite document, when it is pasted into another Graphite document it goes on the layer with the same name from which it was cut or copied. A pasted selection retains its original attributes.

Any geometry on a layer that is not in the new Graphite document is placed on the current work layer. So, make sure that the new document has all the layers of the pasted geometry by creating those corresponding layers in the new document before pasting the geometry.

2. Objects cut or copied from non-Graphite documents are pasted onto the work layer.

### Tip:

It is also possible to create a copy of an object or text box with the **Selection** tool. First select the object, then hold down the CTRL (Windows) or the OPTION (Macintosh) key and drag a copy of the object to a new location.

Copy an object using any of the **Transformation** tools by holding down the CTRL (Windows) or the OPTION (Macintosh) key while using the tool.

## Delete

The Delete command in the Edit menu removes a selection without placing it onto the Clipboard. It is possible to *Undo* this deletion, but not *Paste* what is deleted. In addition to this command, use the DELETE (Windows and Macintosh) or BACKSPACE (Windows only) key to delete a selection. (Retrieve what was deleted with the *Undo* command).

## Undo

CTRL+Z (Windows); ⌘+Z (Macintosh)

This command in the Edit menu reverses the last action. For example, if an object is deleted, choose *Undo* to restore it. Then use *Redo* to return to the deleted version.

*Undo* affects actions that create and edit geometry and text, but not on actions that do not change the contents of the drawing, such as resizing the window or quitting.

When using a tool which involves a multi-step process, such as constructing with **Connected Lines** or creating a **3-Entity Fillet**, choosing *Undo* reverts to the beginning of the process. Some other activities can be stopped by pressing the ESC key. The number of Undo commands is specified using **Layout>Preferences>Undos**.

## Redo

CTRL+SHIFT+Z (Windows); No Key Command (Macintosh)

The Redo command in the Edit menu reinstates the last action reversed by *Undo*. Use *Undo* and *Redo* an unlimited number of times depending upon what is specified in the Preferences.

## Erasing Geometry

There are use several methods to erase objects:

- Select the object(s), then press the BACKSPACE (Windows) or DELETE (Macintosh) key. (Retrieve what was deleted with the *Undo* command).
- Select the object(s), then choose the *Delete* command from the Edit menu. (Retrieve what was deleted with the **Undo** command).
- Select the object(s), then choose **Edit>Cut**. (Retrieve what was cut by using the *Paste* command, as long as nothing else has been cut or copied).

## Changing the Characteristics of Objects

Edit selected objects either by changing individual characteristics, such as weight or color, from the menu, or by changing the specifications in the Edit Objects dialog box.

The Edit Objects dialog box also provides information about the selected object in addition to allowing making changes.

### Edit Objects Command

CTRL+I (Windows); ⌘+I (Macintosh)

The Edit Objects command in the Edit menu changes the individual characteristics of selected objects, such as weight, layer, or pen style, or other specifications. Changes made through this dialog box are reversed with the *Undo* and *Redo* commands.

#### Editing Objects

1. Select the object to be edited.
2. Choose **Edit>Edit Objects**.  
The dialog box appears.
3. Change the information in the data fields.

Click the data field, type a new entry and press ENTER (Windows) or RETURN (Macintosh). The object is modified instantly.

Many data fields have pop-up menus for selection. Press the down arrow and then drag to the selection desired. Once you click the option from the pop-up menu, the object is modified.

4. Click the Close button to close the Edit Objects dialog box.

Use *Undo* and *Redo* to reverse changes made through this dialog box.

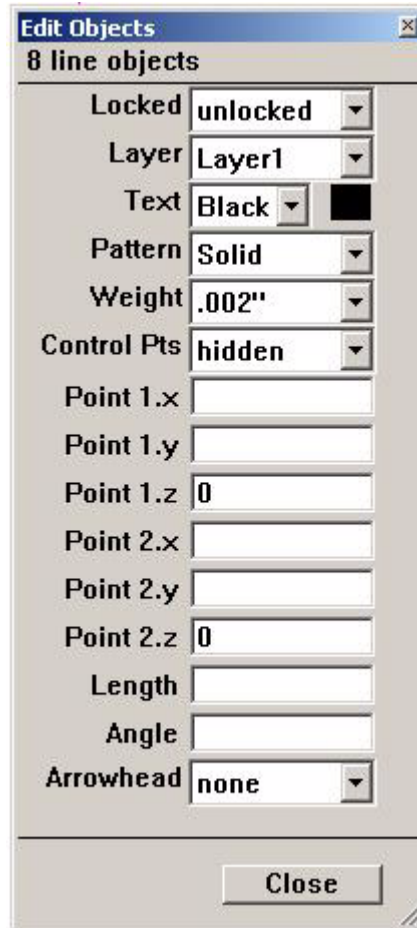

#### Tip:

It is often faster to change a single geometric characteristic of an object by simply clicking the object and changing the geometry in the Status Line. But when changing several characteristics or attributes, it is better to use the Edit Objects dialog box.

*Tip:*

Use the **Expand/Shrink** tool as well as the *Edit Objects* command to edit the measurements of existing objects. This dialog box is a fast, easy way to make several changes at once.

*Tech Note:*

Use mathematical operators in the Edit Objects dialog box. A list of all allowed operators is in Appendix A.

*Tech Note:*

Use different units in each data field like inch ("), feet('), feet/inches (x'y"), centimeter (cm), millimeter (mm), or meter (m). It is possible to mix English and metric units as long as they are labeled correctly like 10" + 25.4 cm.

The specifications shown in the dialogue box depend on the type of object selected, and include at least the following:

- Number (or type) of objects
- Lock status
- Current layer
- Current color
- Current pattern
- Current weight
- Absolute coordinates for the starting point and ending point of the object

The measurements reflect the settings of the *Units* option in the Preferences submenu. To prevent changes to an object, specify *locked* in this dialog box, or select the object and choose *Lock* from the Arrange menu.

When doing a lot of editing, leave the Edit Objects dialog box displayed. That way it is possible to select the object, make the changes in the dialog box, click Apply, and then go on to the next object.

If more than one object is selected when *Edit Objects* is chosen, only the common information is displayed. Entries are blank when the information isn't common. For example, if selecting two concentric circles, the center displays in the Edit Objects box but the diameter box is blank.

If several objects are selected and then *Edit Objects* is chosen, all of the objects reflect the changes made in the dialog box. For example, if all dimensions are selected and the text entry in the Edit Objects dialog box is changed to **2**, all the dimensions display a 2.

### ***Moving an Object to a Different Layer***

1. Select the object(s) to be moved.
2. Choose **Edit>Edit Objects**.
3. Click the arrow for the Layer data field.
4. Click the layer from the list.
5. Choose Apply.

## Arranging Geometry

The Arrange menu contains commands that subdivide geometry, group geometry so it behaves like a unit, and lock geometry to prevent changes. This menu also contains a command to refresh the screen after geometry have been changed.

### Divide Command

This command in the Arrange menu subdivides the selected geometry into the specified number of equal parts.

1. Select the object to be divided.
2. Choose **Arrange>Divide**.

The dialog box appears.

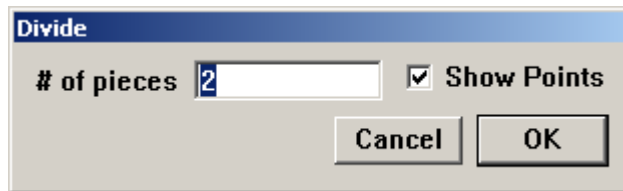

3. Enter the number of equal parts to divide the selection.
4. Click OK.

The divisions can be seen when displaying the points by clicking **Show Points** in this dialog box or choosing **Layout>Show Points**.

## Group Command

CTRL+Y (Windows); ⌘+Y (Macintosh)

The Group command in the Arrange menu combines selected objects to function as a single object.

1. Select the objects to be grouped.
2. Select **Arrange>Group**.

Once geometry is grouped, the individual objects within the group can't be edited unless ungrouped.

If the group is moved, all components move together. If the size of a group is changed, the individual objects change proportionally.

It is also possible to combine groups. For hierarchical groupings, Graphite ungroups each group in the order in which they were combined.

To create temporary groups, which are useful when moving multiple objects, drag a selection fence around several objects to treat them as a single unit while they are selected.

### ***Changing the Members of a Group without Adding a Hierarchical Level***

To add new geometry to an existing group, select the group and the new geometry and choose the **Group** command. This method creates a group within a group. To make a single group, follow these directions:

1. Select the group.
2. Choose **Arrange>Ungroup**. The geometry ungroups with the individual objects selected.
3. Hold down the SHIFT key and select the geometry to be added to the group.
4. Choose **Arrange>Group**.

Follow a similar procedure to remove members of a group.

## Ungroup Command

The Ungroup command in the Arrange menu separates grouped objects into their individual components.

1. Select the group.
2. Choose **Arrange>Ungroup**.

The group becomes individual objects once again.



## Lock Command

The Lock command in the Arrange menu prohibits editing or movement of selected geometry.

### ***Preventing Accidental Changes to One or More Objects***

1. Select the objects to be locked.
2. Choose **Arrange>Lock**.

Although moving or changing a locked object is not allowed, it is possible to copy, group, and select it.

Selected objects can also be locked or unlocked by clicking the *locked* box in the Edit Objects dialog box.

### ***Preventing Changes to an Entire Document***

1. Choose **Edit>Select All**.
2. Choose **Arrange>Lock**.

Selected objects can also be locked or unlocked by clicking the Locked box in the Edit Objects dialog box.

## Unlock Command

The Unlock command in the Arrange menu removes the lock in the selection. Change and move the unlocked objects.

1. Select the locked object(s).
2. Choose **Arrange>Unlock**.

Selected objects can also be locked and unlocked by clicking the Locked box in the Edit Objects dialog box.

## Redraw Screen Command

CTRL+R (Windows); ⌘+R (Macintosh)

The Redraw Screen command in the Arrange menu refreshes the screen. When changes are made to the constructions, the geometry may not be redrawn cleanly in the drawing area.

### ***Redrawing the Screen***

To redraw all of the geometry and remove extraneous artifacts, choose the *Redraw Screen* command from the Arrange menu.

***Stopping a Screen Refresh***

*Windows:* Press the ESC or BREAK key to stop the redrawing of the screen. For interrupting long operations such as redraw, or linear or polar duplicate, use the BREAK key. If the operation was initiated by a control key command (such as CTRL+R for redraw) the ESC key is read by MS-Windows and it brings up a task list at the end of the operation.

*Macintosh:* Press ESC or the Command (⌘) key to stop the screen from redrawing.

# Adding Details

Once the basic geometry is created, add notations or highlight certain portions of the geometry. This chapter discusses a few ways to do so. The topics covered include:

- Text
- Crosshatching and Solid Fills
- Arrowheads

## *Text*

When the drawing needs to be annotated, use the **Text** tool to create a text box for entering characters from the keyboard. Create, import and edit text on the screen, using the Text menu to set the characteristics, such as font, text size, style, alignment, line spacing and indent.

There are nine text handles for each text object. These help move and/or align the text as necessary.

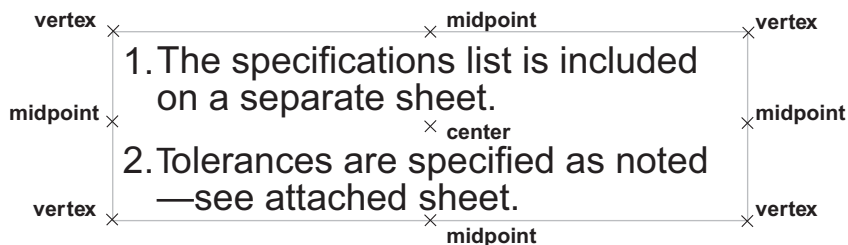

## Text Tool



The **Text** tool, creates and edits text on screen. The text entered has the characteristics set in the Text menu.

### Using the Text Tool

1. Select the **Text** tool from the tool palette. The Message Line reads, *Text: Pick opposite corners of text entry box [Ctrl = Copy Previous (Windows) or Option = Copy Previous (Macintosh)].*

2. Create a text box by dragging or by clicking two locations to place the opposite corners of the text area.

The text box is as tall as a single line of text and as wide as indicated. The text cursor appears in the box, ready for the typing.

3. Enter the desired text from the keyboard.

Pressing the BASKSPACE (Windows) or the DELETE (Macintosh) key erases characters to the left of the cursor.

The text entered automatically *word wraps* to the next line when it reaches the right side of the text box created in step #2. If the text box is resized, the words rewrap automatically.

The Status Line specifies the X and Y location of the first text box corner, the text box width and height.

X  Y  W  H

### Importing Text

Small portions of text may be copied and pasted into a text box from other sources such as a word processing document.

It is also possible to import an ASCII file that contains text into the drawing. For example, place specifications written with a word processor on the drawing without retyping them. The entire file imports, so to use only part of the document, create a new file that contains only the information to be entered on the drawing. To import a file:

1. Select the **Text** tool from the tool palette.
2. Create a text box by dragging or clicking twice to place the opposite corners of the text area.
3. Choose **File>Import**.

#### *Tech Note:*

An ASCII text file is usually created by word processing software and saved as plain text. It usually contains only standard keyboard characters—letters, numbers, punctuation, and spaces—without the formatting typically found in word processing documents.

A dialog box appears.

4. Select the text file to import.

When the Import dialog box appears, specify the Text as the file type.

5. Click OK.

The text file appears in the text box created.

### ***Editing Text***

1. Select the **Text** tool from the tool palette.

2. Move the pointer directly over the text to be edited. The pointer turns into an *I-beam* text cursor when it is over text. (This only occurs when the **Text** tool is active.)

3. Use the text cursor to select text.

Drag either direction to select characters, double-click on an individual word to select it, or click to place the text cursor within the existing text to add or change it.

4. Modify the selected text by choosing the appropriate commands from the Text menu.

#### *Tip:*

To change characteristics for the entire text entry, use the **Selection** tool to select the text block.

### ***Changing the Characteristics of a Block of Text***

Change the font, text size, style, spacing and indentation of a block of text.

1. Use the **Selection** tool to select the block of text to be changed.

2. Select the new characteristic from the Text menu.

The selection shows the new characteristic.

#### *Tip:*

To change the characteristics of a word or portion of a text block, use the **Text** tool to select what to change.

### ***Changing the Size of the Text Box***

1. Click the **Selection** tool.

2. Drag a selection fence around the right side of the text box.

The dotted lines shown in the following graphic do not appear on the screen.

**Note:** For single lines of text, if it is not possible to select the control points on the right side of the text box, it may be that the original text box extends further than the edge of the text. With the **Selection** tool, first select the text by clicking on it. When the text box appears, drag a selection fence around the right side.

The control points mark the boundaries of the text box when it is first created.

3. Drag the control points to the right as shown below or to the left to make the text box smaller.

The area changes size and the text rewraps automatically.

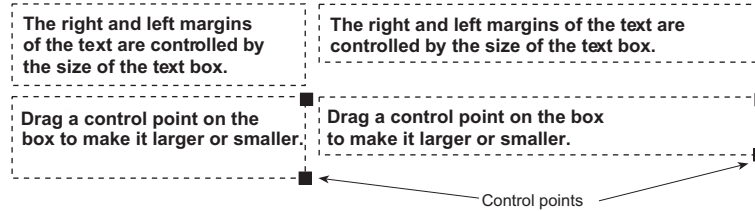

In the Edit menu, *Selectable Points* must be active for selecting the control points of the text box.

### ***Moving Text***

1. Choose the **Selection** tool. 
2. Select the text object to move.
3. Move the cursor over the text object. The cursor becomes a 4-way Move symbol.



4. Place the 4-way Move symbol at the desired handle location using the Drafting Assistant notations as a guide.
5. Drag the text object to the new location.

### **Spell Check**

To spell check any text item in a drawing:

1. Select the text to check.
2. Access the spell check function using one of the following:
  - Choose **Text>Spell Check**.
  - Right click the mouse and choose Spell Check from the context menu that appears.
  - Choose **Spell Check** tool from the **Text** palette. 
3. The Spell Check dialog box operates like any spelling checker. It is necessary to have the required files in the directory named "Spell" of the Graphite application folder. The user requested additions are compiled in the userdic.tlx file.

## Text Menu

The Text menu contains commands for changing the text font, size, and style, as well as the justification, spacing and indentation.



### Font

The Font command in the Text menu changes the font for selected text or future text entries.

The fonts listed in the menu are those installed on the computer and include Ashlar-Vellum's Plotter fonts. Use a Plotter font whenever creating text for a drawing that is intended to be sent to a plotter, since plotting Postscript or TrueType fonts take much more time to plot or may be substituted.

The selected font stays in effect for the current document until another font is chosen.

**Note:** The fonts used for dimensions are the same set of fonts as those used for the text, however, they are set in the Dimension menu.

Special characters and accents are available as described in Appendix B.

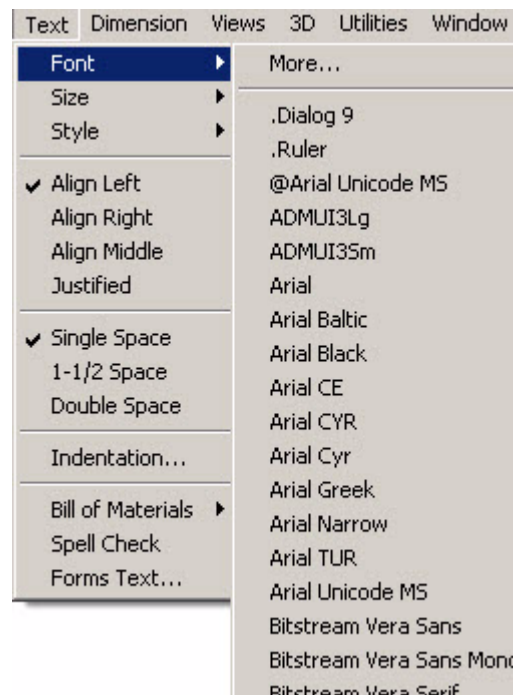

*Tech Note:*

Macintosh users: All fonts available in the system are displayed in the fonts list so there is no Extended font selection process.

**Extended Font Selection (Windows)**

The Font submenu displays up to 20 fonts. If more than 20 fonts are installed, select *More* in the Font submenu of the Text menu for more available fonts.

Choosing *More* brings up a dialog box for specifying the font, text size and text style. The text size is measured as a point size. To specify the size in the units set for the drawing, type the exact unit such as " for inch or mm for millimeter after the value.

1. Choose **Text>Font>More**.

The Character Format dialog box displays:

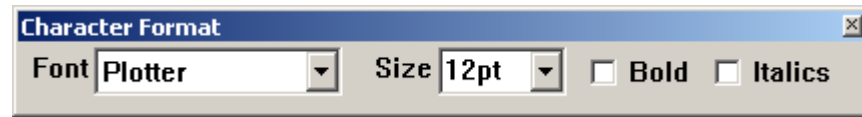

2. Select the character format.
3. Click Apply.

Leave this dialog box open to assign other character formats. To close this dialog box, double click the Control pull-down menu in the upper left corner of the dialog box.

The character format specified stays in effect until another character format is chosen.

**Rotating Text**

Text, including Postscript and TrueType fonts, can be rotated with the **Rotate** tool like any other object in the drawing. Text that is neither horizontal nor vertical may appear jagged on the screen, but it should print at the system's highest quality.

**Font Sizes and ANSI Standards**

A typical system font specified for .156 inches may produce a character that is only .125 inches. The variation depends on the proportional spacing of the font. To set a font to exact specifications, use a Plotter font, which conforms to ANSI standards.



## Size

The Size command in the Text menu sets the font size for the selected text or for future text entries in the current document. This can be specified as either points (12 pt) or units (.156 inches) as defined in the Units dialog box within

**Layout>Preferences>Units**. If no unit is specified, Graphite picks the default unit.

### Specifying a Non-standard Text Size

Choosing *Other* from the Size submenu brings up a dialog box to enter the exact text size in point size, inches or metric units. If a unit is not specified the default unit for the drawing is used.

1. Choose **Text>Size>Other**.
2. Enter the size. The size is measured in the current units as set in the Preferences submenu. To specify a point size, include pt with the numeric entry.
3. Click OK.

The size specified stays in effect until another size is chosen.

### Text Size and Scaling

Making changes to the scale in the Drawing Size dialog box in the Layout menu, changes the text size inversely. For example, if the drawing is scaled 1:4, multiply the text size by 4 for it to display properly on the drawing. Also use the *Keep Text Size* and *Keep Dimension Text Size* options from the Drawing Size dialog box when changing the Drawing Scale to change the size of the text relative to the size of the other objects.

If it looks right on the screen, the scaling is appropriate. See the chapter on Graphite Documents for more information on scaling.

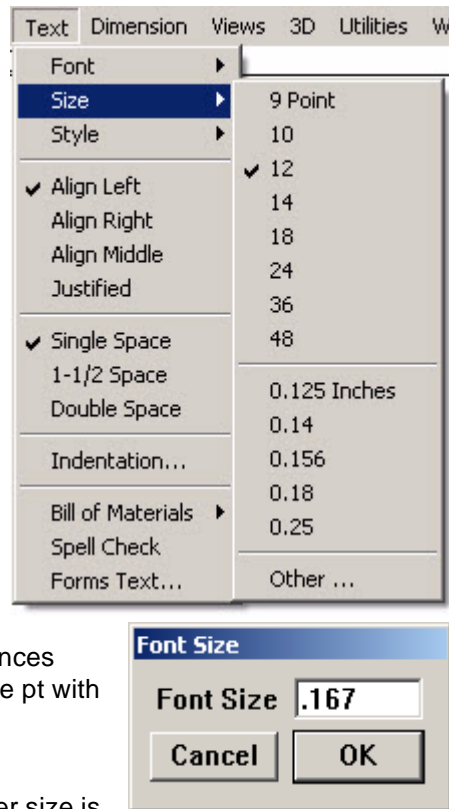

## Style

The Style command in the Text menu sets the style (such as **Bold** or Underline) for selected text or future text entries.

The style specified stays in effect until another style is chosen. A check mark indicates the current style. Change the default setting by saving the changes in the preferences file (*prefs.vc6* - Windows, or *Graphite prefs* - Macintosh). Choose **Layout>Preferences>Save Preferences**.

## Text Alignment

The four commands in the second section of the Text menu align the text within the text box. The text can be aligned on the left, the right, centered in the middle, or it can be fully justified so that it is aligned with both left and right margins of the text box.

If the **Text** tool is active, both the selected text and future text are aligned as specified, but existing text is not aligned. If another tool is active when any of these commands are chosen, only future text entries are aligned. If a text entry is selected when any of these commands are chosen, the selection and future text entries are aligned as specified.

### Align Left

Align Left in the Text menu aligns the selected and future text at the left margin of the text area.

### Align Middle

Align Middle centers the selected and future text in the text area.

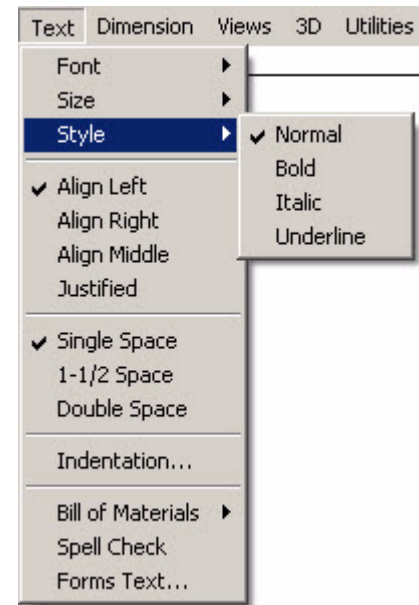

Text alignment is controlled from the Text menu. You can align text with the left or the right margins, with both margins, or centered between the margins.

Text alignment is controlled from the Text menu. You can align text with the left or the right margins, with both margins, or centered between the margins.

### ***Align Right***

Align Right aligns the selected and future text at the right margin of the text area.

Text alignment is controlled from the Text menu. You can align text with the left or the right margins, with both margins, or centered between the margins.

### ***Justified***

Justified aligns both the left and right margins of the selected and future text in the text area.

The text alignment is controlled from the text menu. You can align text with the left or the right margins, with both margins, or centered between the margins.

## **Text Spacing**

The Text menu has commands for single, space-and-a-half, or double spacing between the lines of the text.

Text spacing is controlled from the Text menu.

The check mark in the Text menu indicates the current line spacing. Change the default setting by saving changes in the Preferences file.

Text can be single spaced like the first paragraph or set at one and a half spaces, as in this paragraph.

Text can also be double-spaced like in this paragraph.

### ***Single Space***

Single Space sets the spacing of selected and future lines of text so each line occupies one space in the text area.

### ***1-1/2 Space***

This command changes the spacing of selected and future text so each line occupies one and a half spaces in the text area.

### ***Double Space***

This command sets the spacing of selected and future text so each line occupies two spaces in the text area.

## Indenting Text

To indent the text on the right or left side of the text box, or to have the first line indented, choose **Text>Indentation**.

### Indentation Command

The indentation command in the Text menu sets the indentation of paragraphs for the selected text area as defined by the units set in the Preferences submenu.

1. Choose **Text>Indentation**.

The dialog box appears.

2. Specify the indentation. Use point values if pt is included in the entry.
3. Click OK.

Specify the number of units for any or all the choices:

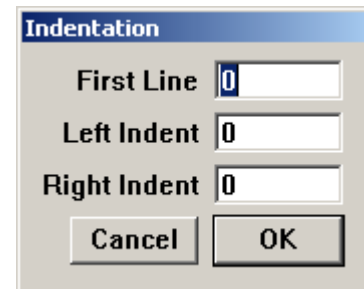

#### First Line

Sets the number of units for the indentation of the first line of each paragraph.

This is an example of a paragraph with the first line indented.

#### Left Indent

Sets the number of units for the indentation on the second and following lines of the left margin of each paragraph.

2. This is an example of a paragraph with a left indent.

#### Right Indent

Sets the number of units for the indentation of the right margin of each paragraph.

This is an example of a paragraph with a right indentation.



## Crosshatching and Solid Fills

### *Tech Note:*

Crosshatching appears parallel to the work plane and only in the view in which it was created. In other words, it is drawn correctly when viewed along the z-axis of the work plane.

Graphite can crosshatch and fill any enclosed area in the drawing and then automatically update the crosshatching or fill when changing the dimensions of the enclosed area. If a closed area with a hole or other cutout in it is specified, Graphite accurately excludes the hole area from the crosshatching.

In the Pen menu are two fill commands: *Solid Fill* and *Fill*, and two crosshatch commands: *Crosshatch* and *Hatch*. *Fill* creates a solid fill for a selection with the current pen color. *Hatch* crosshatches the selection with the default pattern or the last pattern selected. *Solid Fill* sets the tolerance for the fill. To change the hatch patterns, choose *Crosshatch* and specify the pattern to use. To change the default hatch pattern, make changes to the preferences file as described in Chapter 5, Basic Environment Settings.

Choose the *Fill* command from the keyboard with CTRL+B (Windows) or ⌘+B (Macintosh) and the *Hatch* command from the keyboard with CTRL+H (Windows) or ⌘+H (Macintosh).

### Crosshatch Patterns

A wide variety of Crosshatch patterns are available in both ISO or DIN styles. Crosshatching appears parallel to the work plane, and only in the view in which it is created. In other words, it is drawn correctly when viewed along the z-axis of the work plane.

The following ISO crosshatching options are available.

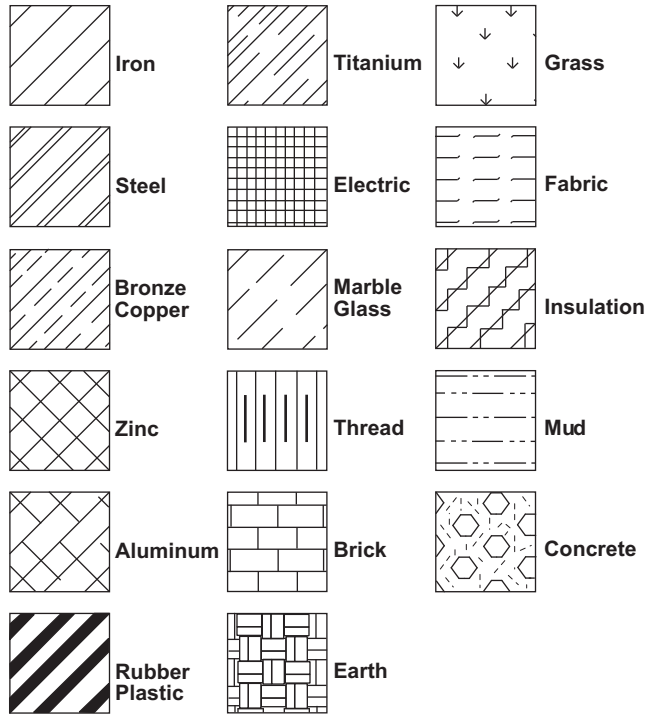

The following DIN crosshatching options are available.

Legend

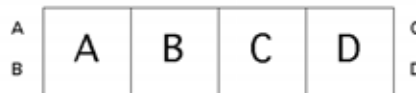

DIN Patterns

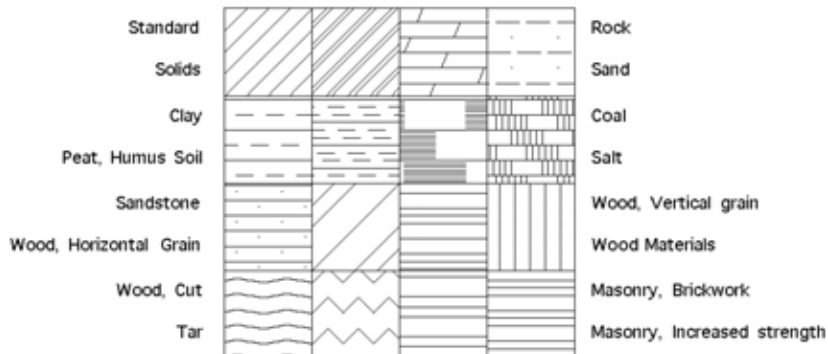

Masonry, Light Brick			Plaster Plate
Masonry, Pumice			Plaster, Mortar I
Plaster, Mortar II			Concrete, non-reinforced
Concrete, Reinforced			Pumice, concrete
Concrete, Waterproof			Fiber
Glass			Ceramic
Porcelain			Insulating material
Firebrick			Sealing material
Steel, alloy			Cast Iron
Steel, non-alloy			Light Metal
Heavy Metal			Durable plastic
Rubber, Elastic materials			Thermoplastic
Water			Fuel
Oil			

*Tech Note:*

To crosshatch Smart Walls containing smart symbols, first segment the walls to create hatch boundaries. Since smart symbols cover only wall segments, they can't be used as hatch boundaries.

*Tip:*

To crosshatch a figure that is not a closed figure, add lines or segment lines to make a closed figure. In this way, crosshatch individual sections of the geometry. See "Crosshatching" in the "Advanced Features" section of the *Getting Started* manual for a step-by-step example.

**Specifying the Fill or Crosshatch Area**

The selected objects must completely enclose the area that needs to be crosshatched or filled. For example, to crosshatch or fill the object below; select all of the lines making up the part, including the holes.

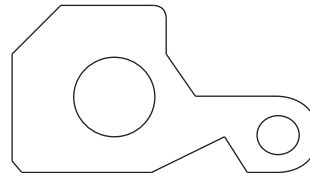

The exterior lines define the boundary for the crosshatching or solid fill. The two holes tell Graphite that those enclosed areas within the original area should not be crosshatched or filled. Once the lines and holes are selected, in the Pen menu, choose the *Hatch, Fill, Crosshatch*, or the *Solid Fill* command and specify the pattern to use.

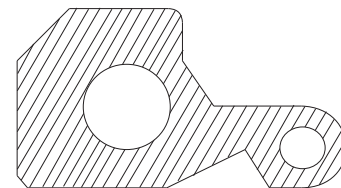



It is important not to select extra objects when specifying the crosshatch or fill area because Graphite does not know how to treat the extra objects.

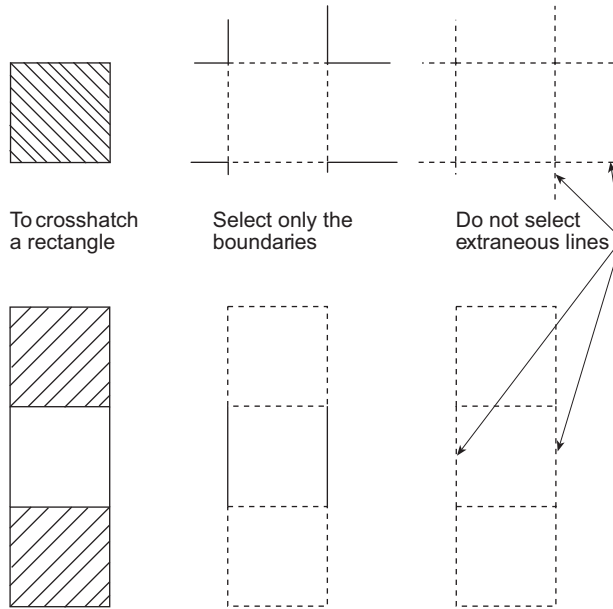

*Tip:*  
Use the **Tracer** tool to select the boundary.

### ***Crosshatch Command***

The Crosshatch command in the Pen menu crosshatches the selection with one of the industry standard crosshatching patterns. Change the default pattern by saving changes in the preferences file. See Chapter 5, “Basic Environment Settings.”

### Adding Crosshatching

1. Select the objects which represent a closed boundary. The closed boundary may include cutout areas such as a hole. Select both the outside boundary and the hole.
2. Choose **Pen>Crosshatch**.

The dialog box appears displaying DIN crosshatching options.

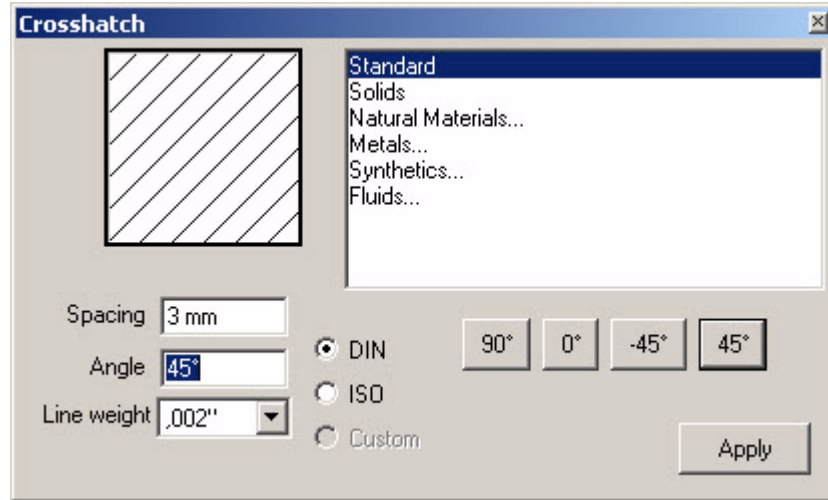

3. To display ISO crosshatching options, click the ISO radio button in the dialog box.

### Using ISO Crosshatching

1. Click the ISO radio button to display the ISO patterns. The dialog box displays.
2. Select the pattern from the menu.

The pattern selected appears in the Pattern display area as it will appear on the drawing.

3. Change the spacing and angle, if desired.

When making changes to the angle or spacing, the pattern box shows the revised pattern exactly as it is when the specified object is crosshatched.

4. Click Apply.

### Using DIN Crosshatching

1. Select the pattern from the menu. Those patterns that have an ellipsis (...) following their name have their own submenu. Double-click on one of those names to display the submenu.

To return to the main menu, double-click on the ellipsis at the top of the submenu.

The pattern selected appears in the Pattern display area as it appears on the drawing.

2. Change the spacing and angle, if desired.

When making changes to the angle or spacing, the pattern box shows the revised pattern exactly as it is when the specified object is crosshatched.

3. Click Apply.

### Editing an Existing Crosshatch Pattern

1. Select the existing crosshatching by clicking it with the Selection tool.
2. Choose **Pen>Crosshatch**.
3. Make the changes in the Crosshatch dialog box.
4. Click Apply.

The crosshatching changes as specified.

**Note:** The line style of any specific crosshatch pattern is not editable. Only the space and angle can be adjusted.

### Hatch Command

CTRL+H (Windows); ⌘+H (Macintosh)

The hatch command, located in the Pen menu, crosshatches the selected objects using the current crosshatch pattern. To change the crosshatch pattern, choose *Crosshatch* and make the selection from the dialog box.

The best way to select a hatch boundary is with the **Tracer** tool.

### Crosshatching with the Current Pattern

1. Select the object to crosshatch.
2. Choose **Pen>Hatch**.

The selected area is crosshatched with the current pattern.

### **Solid Fill Command**

The Solid Fill command in the Pen menu fills the selection with the current pen color.

A solid filled object covers its background only if it is the last entity drawn. To make a solid filled object cover its background, select it again before printing or saving to bring it on top.

### **Creating a Solid Fill**

1. Select the objects which represent a closed boundary. The closed boundary may include cutout areas like a hole. Select both the outside boundary and the hole.
2. Choose **Pen>Solid Fill**. The Fill dialog box appears.
3. Enter a *Tolerance* for the fill.

The tolerance controls how smooth the linearization is for fills in circles, arcs, ellipses and closed splines. Increasing the value of *Tolerance* makes the fill smoother. The default value is 0.01 (A value of 0.001 produces smoother edges than .01. This is also affected by Drawing Scale.)

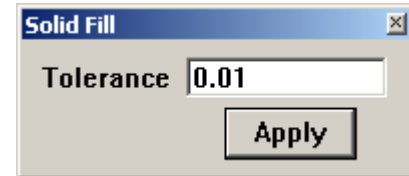

4. Click Apply.

The selected object fills with the current pen color.

### **Changing the Color of an Existing Solid Fill**

1. Select the existing solid fill by clicking it with the **Selection** tool.
2. In the Pen menu, choose a new color from the Color submenu.

The Fill color changes as specified and is visible as soon as the solid fill is deselected.

### **Changing the Tolerance of an Existing Solid Fill**

1. Select the existing solid fill by clicking it with the **Selection** tool.
2. Choose **Pen>Solid Fill**.
3. Change the *Tolerance* and press Apply.

The *Tolerance* may also be changed using the Edit Objects dialog box.

## Fill Command

CTRL+B (Windows); ⌘+B (Macintosh)

This command is located in the Pen menu and fills the selected objects using the current pen color. To change the fill color, in the Pen menu, change the color from the Color submenu.

### Fill with the Current Pen Color

1. Select the object to fill.
2. Choose **Pen>Fill**.

The selected area fills with the current pen color.

## Arrowheads

To use arrowheads on lines or circular arcs that are not a part of dimensions, specify the placement of arrowheads in the Pen menu. An arrowhead may appear at the beginning or end of a line or circular arc, or at both the beginning and end.

### Width of Arrowhead

The width of the arrowhead is based on the text size.

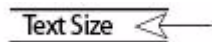

### Arrowhead Types

Use the Arrowheads submenu to set one of eight arrowheads for arrow lines.

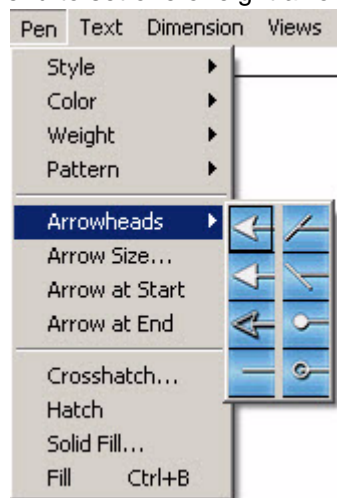

*Tech Note:*

Arrowheads for dimensions are controlled with commands from the Dimensions menu.

*Tech Note:*

The size of the dimension arrowheads is set using the *Arrow Size* command from the Dimensions menu.

### ***Arrow at Start Command***

This command in the Pen menu places an arrowhead at the beginning of any selected and subsequent lines and circular arcs. Choose the type of arrowhead from the Pen menu. A check mark indicates the current arrowhead setting. Change the default setting by saving changes in the preferences file.

### ***Arrow at End Command***

This command in the Pen menu places an arrowhead at the end of selected and subsequent lines and circular arcs. Choose the type of arrowhead from the Pen menu. A check mark indicates the current arrowhead setting. Change the default setting by saving changes in the preferences file.

*Tip:*

Add or remove arrows to or from lines and arcs using the Edit Objects dialogue box.

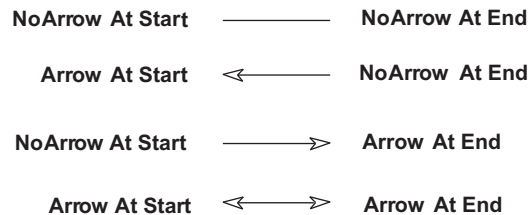

The start and end of a line and an arc are determined by the point that was created first.

# Dimensions

This chapter explains how to use the **Dimension** tools in Graphite. The topics covered include:

- Associative Dimensions
- Dimensioning Overview
- The Dimension Tools
- Dimension Appearance
- Parametric Dimensions

## Associative Dimensions

Graphite's geometric dimensions are associative. This means that when a change is made to the geometry, the dimension changes also. This is not true if a manual dimension was entered in order to use parametrics, such as a value for the # in the dimension text data field).

This associativity is a tremendous time saver because dimensions automatically update whenever a change in the geometry is made. Change the units from English to metric, using the Preferences submenu in the Layout menu, and every dimension on the drawing reflects the change.

When extending a line by selecting the *endpoint* of the line and dragging it to a new position, the dimension changes also, because the dimension has a control point at the same position of the line *endpoint*. So when selecting the *endpoint* of the line is selected, the dimension control point must be selected also.

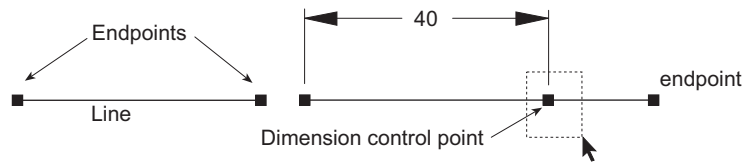

Dimensions are associative relative to the points they measure. When changing the length of a line using the Edit Objects dialog box, the dimension will not update because the point was not changed. To correct the dimension, select the dimension's *vertex* point and drag it to the new *endpoint* of the line.



## Dimensioning Overview

### Dimension Tool Palette

Graphite's individual Dimensioning tools are in the main tool bar of the main Graphite palette.

These tools are used to measure either an object or the area between objects.

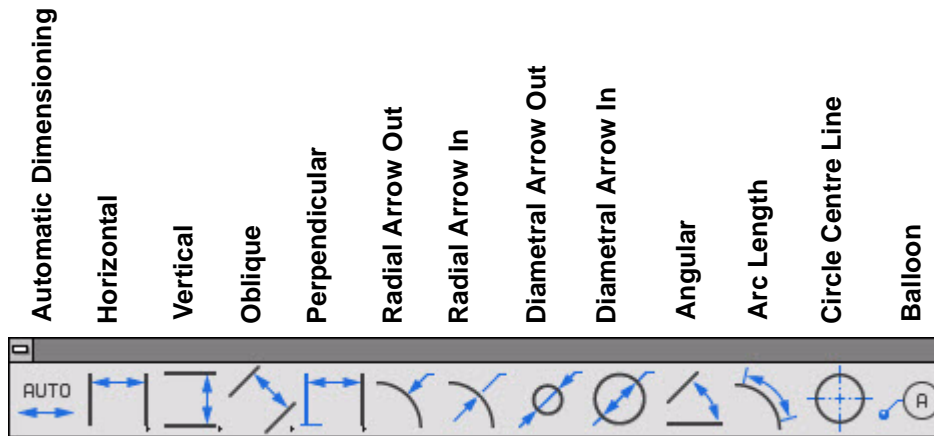

Once an object (or space) is dimensioned, the dimensions update when the changes are made to the geometry.

Like all palettes in Graphite, the Dimension palette can be torn off and positioned anywhere in the drawing area by clicking on the tear-off icon at the end of the fly-out palette and moving it as desired. Change the orientation of the palette by choosing either Vertical or Horizontal option in **Layout>Preferences>Dimensions Palette Orientation**.

Four tools on the **Dimension** palette have subpalettes for base line, chain, and ordinate style dimensions. To access these subpalettes it is necessary to tear off the **Dimensions** palette.

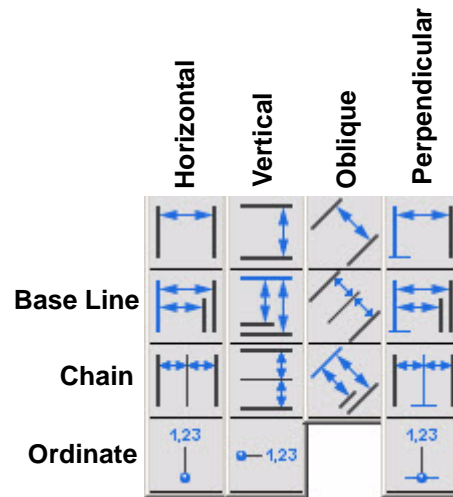

Some of the Dimensioning tools, such as the **Horizontal** and **Vertical** tools, require that two points be selected. Others, such as the **Radial** and **Diametral**, require only one point.

Save the location and the status (on/off) of the **Dimension** palette by choosing **Layout>Preferences>Save Palettes**.

## Dimension Menu

The Dimension menu contains commands for setting the format and tolerance limits for dimensions. These commands are discussed in detail further on in this chapter under Dimension Appearance.

## Dimensioning and the Work Plane

Dimensions appear in the current work plane of the active view. Set the work plane to correspond to the view before adding text or dimensions in a view.

For example, if the current work plane is the top plane, then the dimensions will appear parallel to the work plane regardless of the view. See the graphic on the next page.

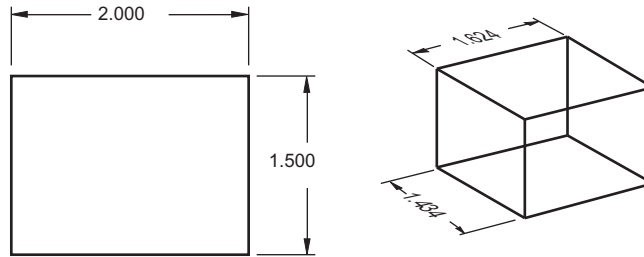

All point to point dimensions are also placed parallel to the work plane. Working in the front plane and using the **Horizontal Dimension** tool, the dimension is placed parallel to the front plane.

## Dimensioning Objects and Placement

1. If necessary, display the **Dimension** palette.
2. Select the appropriate dimension tool.

The dimension pointer is a smart pointer with a hot spot. The dot shows which side of the object to select first. Select as indicated by the position of the dot for the text to appear above or to the right of the leader. If selected in the opposite order, the text appears below or to the left of the leader.
3. Click the points to measure.

Dimensions automatically use the dimension pen style and current dimension text characteristics. To change the dimension pen color or weight, use the Dimension menu. The dimension pattern is changed in the Edit Object dialog box for dimensions that are selected.
4. Move the dimension to a new location as desired. (See the margin note.)
5. When using the dimension with parametrics, change the entry in the text data field on the Status Line.

### *Tech Note:*

Steps #4 and #5 must be done in order. If the entry in the text box is changed and then ENTER (Windows) or RETURN (Macintosh) is pressed, the dimension cannot be moved, because it is no longer selected. To move a dimension, select it and drag it to the desired location.

## Moving the Dimension

When the dimension text appears, it is selected so that it can be moved to a new location. Move the pointer to the dimension text. When the pointer changes to the 4-way Move symbol (the picture below), drag the dimension to its new location.



To move a dimension later, use the **Selection** tool. Click the dimension once, then drag it to the new location.

Also drag to select the dimension text or to select the entire dimension or several dimensions at once.

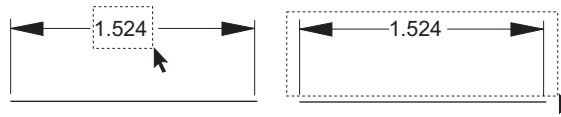

## Using the Dimension Status Line Fields

The status fields shown below appear when a dimensioning tool is selected.

Text #  Upper  Lower

### Text

The # symbol in the text data field indicates that the dimension is the actual value of the object's measurement. If this symbol is deleted, the dimension is no longer associative (it doesn't update if the geometry is changed).

When using parametrics, delete the # symbol and enter values, algebraic expressions, or variables in the text data field. Parametrics are described in Chapter 16.

Some of the dimensioning tools, such as the Radial tools, add a letter in the text status data field which appears in the dimension itself. Add text before or after the # symbol and to enter parentheses to enclose the resulting dimension in parentheses. When the # symbol is included, Graphite uses the measurement of the geometry as well as the text added.

### Tolerance

The Upper and Lower fields appear if a tolerance format is specified (in the Linear or Angular submenu of the Dimension menu). Enter the limits for the tolerance in these fields.

## Automatically Placing Dimensions on a Separate Layer

Graphite automatically creates a dimension layer unless it is removed from the *prefs.vc6* (Windows) or the *Graphite prefs* (Macintosh) file. To create a dimension layer, do the following:

1. Create a layer named **Dimension**. (This name must be spelled correctly.) The dimension layer does not need to be the work layer.
2. Dimension as usual. Subsequent dimensions automatically go on the dimension layer rather than the work layer.

## Adding Tolerance and Limits

1. From the Dimension menu, choose the desired style, either Linear or Angular.
2. Create the dimension.
3. Enter the values in the Status Line for upper and lower tolerance limits and press ENTER (Windows) or RETURN (Macintosh).

## Using Fixed Dimensions

Delete the # symbol in the text data field (on the Status Line for a newly-created dimension or in the Edit Objects dialog box) and replace it with other text. The entry in the text data field is now fixed. It does not update if the units or the size of the geometry is changed.

## Adding Special Symbols to Dimension Text

It is possible to add special symbols to the dimension text. To add a special symbol:

1. Select the desired dimension.
2. Open the Edit Objects dialog box. Next to the Text entry field there is  button. Click the button and a drop down list of symbols appears. Choose the necessary symbol.
3. Click ENTER. The symbol appears in the dimension text.

## The Dimension Tools

### Automatic Dimensions

Auto Dimensioning is a convenient way to add dimensions to drawings quickly and easily. If more control over the dimension is desired, such as the style or tolerances, use the individual dimensioning tools.

#### Automatic Dimensioning Tool



This tool automatically dimensions lines (independently from their angle), circles, ellipses and arcs.

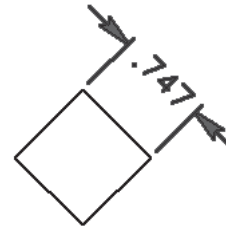

#### Using the Automatic Dimensioning Tool.

1. Choose the **Automatic Dimensioning** tool. The Message Line reads, *Automatic Dimensioning: Select object for Auto dimensioning.*
2. Click at each object with the **Automatic Dimensioning** tool.

All lines are dimensioned correctly. All circles, arcs and ellipses are dimensioned with a radial dimension.

## Horizontal Dimension Tools



These tools measure horizontal spaces or the distance between linear objects. To access this subpalette, tear off the **Dimension** palette from the main tool bar.

### *Horizontal Dimension Tool*



This tool dimensions an object or space horizontally.

### Using the Horizontal Dimension Tool

1. Select the **Horizontal Dimension** tool. The Message Line reads, *Horizontal: Pick first dimension point.* The Message Line guides each successive step.
2. Click the left point of the geometry.
3. Click the right point.

The dimension appears. Drag it to a new location. Dimension and extension lines automatically redraw.

Click the points in the opposite order to display the dimension below the objects.

When the dimension text appears, drag it to a new location. Release the mouse button and the dimension and extension lines are redrawn.

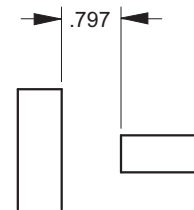



### Horizontal Base Line Dimension Tool



This tool dimensions objects or spaces horizontally from a base point.

#### Using the Horizontal Base Line Dimension Tool

1. Select the **Horizontal Base Line Dimension** tool. The Message Line reads, *Horizontal Base Line: Pick first dimension point.* The Message Line guides each successive step.
2. Click the base point of the geometry.
3. Click the point. The dimension appears.
4. Click the next place for the dimension. This dimension appears above the first, measured from the base point. Continue clicking the points to be dimensioned. Drag each dimension to a new location. Dimension and extension lines automatically redraw.

Click the points in the opposite order to display the dimension below the objects.

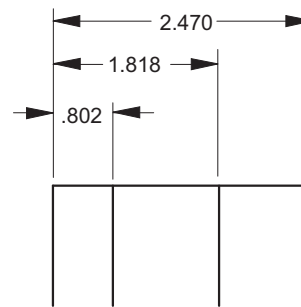

#### Tip

To access the subpalette, tear off the **Dimension** palette from the main tool bar.

### Horizontal Chain Dimension Tool



This tool dimensions objects or spaces from end-to-end, horizontally.

#### Using the Horizontal Chain Dimension Tool

1. Select the **Horizontal Chain Dimension** tool. The Message Line reads, *Horizontal Chain: Pick first dimension point.* The Message Line guides each successive step.
2. Click the first point on the geometry.
3. Click the second point. The dimension appears.
4. Click the next place for the dimension. This dimension appears, measured from the last point clicked. Continue clicking all the points to be dimensioned. Drag each dimension to a new location. Dimension and extension lines automatically redraw.

Click the points in the opposite order to display the dimension below the objects.

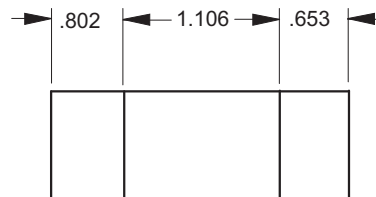

### Horizontal Ordinate Dimension Tool



This tool dimensions objects or spaces horizontally from a base point.

#### Using the Horizontal Ordinate Dimension Tool

1. Select the **Horizontal Ordinate Dimension** tool. The Message Line reads, *Horizontal Ordinate: Pick first dimension point*. The Message Line guides each successive step.
2. Click the base point of the geometry.
3. Click the second point. The dimension appears, measured from the base point.
4. Click the next point for the dimension. This dimension appears measured from the base point. Continue clicking all the points to be dimensioned. To display a dimension at the base point, click the base point after having dimensioned all other points.

Drag each dimension to a new location. Dimension and extension lines automatically redraw.

**Reminder:** To display the dimension number of the base point, click it at both the first and the last dimension points.

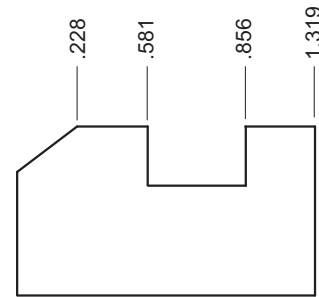

## Vertical Dimension Tools



These tools measure vertical space or the distance between vertical objects. To access this subpalette, tear off the Dimension palette from the main tool bar.

### Vertical Dimension Tool



This tool dimensions an object or space vertically. Click the top point first, then click the bottom.

#### Using the Vertical Dimension Tool

1. Select the **Vertical Dimension** tool. The Message Line reads, *Vertical: Pick first dimension point.* The Message Line guides each successive step.
2. Click the top point of the geometry first.
3. Click the bottom point.

The dimension appears. Drag it to a new location. Dimension and extension lines automatically redraw.

Click the points in the opposite order to display the dimension on the other side of the objects.

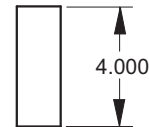

### Vertical Base Line Dimension Tool



This tool dimensions objects or space vertically from a base point.

#### Using the Vertical Base Line Dimension Tool

1. Select the **Vertical Base Line Dimension** tool. The Message Line reads, *Vertical Base Line: Pick first dimension point.* The Message Line guides each successive step.
2. Click the base point of the geometry.
3. Click the second point. The dimension appears.
4. Click the next place for the dimension. This dimension appears to the right of the first, measured from the base point. Continue clicking all the points to be dimensioned. Drag each dimension to a new location. Dimension and extension lines automatically redraw.

Click the points in the opposite order to display the dimension on the other side of the objects.

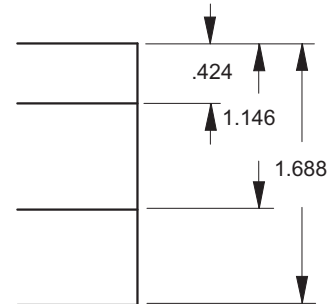

### Vertical Chain Dimension Tool



This tool dimensions objects or space from end-to-end, vertically.

#### Using Vertical Chain Dimension Tool

1. Select the **Vertical Chain Dimension** tool. The Message Line reads, *Vertical Chain: Pick first dimension point.* The Message Line guides each successive step.
  2. Click the first point on the geometry.
  3. Click the second point. The dimension appears.
  4. Click the place for the dimension. This dimension appears, measured from the last point clicked. Continue clicking all the points to be dimensioned. Drag each dimension to a new location. Dimension and extension lines automatically redraw.
- Click the points in the opposite order to display the dimension on the other side of the objects.

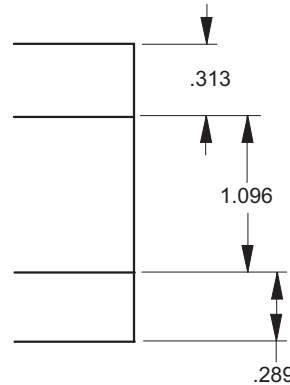

#### Tip

To access the subpalette, tear off the **Dimension** palette from the main tool bar.

### Vertical Ordinate Dimension Tool



This tool dimensions objects or space vertically from a base point.

#### Using the Vertical Ordinate Dimension Tool

1. Select the **Vertical Ordinate Dimension** tool. The Message Line reads, *Vertical Ordinate: Pick first dimension point*. The Message Line guides each successive step.
2. Click the base point of the geometry.
3. Click the second point. The dimension appears, measured from the base point.
4. Click the next point for the dimension. This dimension appears measured from the base point. Continue clicking all the points to be dimensioned. To display a dimension at the base point, click the base point after having dimensioned all other points.

Drag each dimension to a new location. Dimension and extension lines automatically redraw.

**Reminder:** To display the dimension number of the base point, click it twice at both the first and the last dimension points.

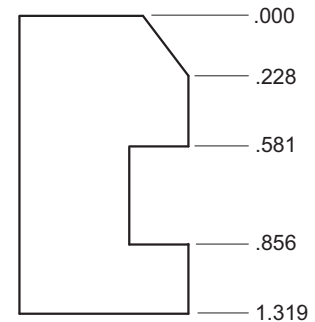

## Oblique Dimension Tools

These tools measure space or objects, obliquely or point to point. To access this subpalette, tear off the **Dimension** palette from the main tool bar.



### *Oblique Dimension Tool*



This tool dimensions an object or space from point to point or obliquely.

#### Using the Oblique Dimension Tool

1. Select the **Oblique Dimension** tool. The Message Line reads, *Oblique: Pick first dimension point*. The Message Line guides each successive step.
2. Click the left point first.
3. Click the right point. The dimension appears. Drag it to a new location. Dimension and extension lines automatically redraw.

Click the points in the opposite order to display the dimension on the other side of the objects.

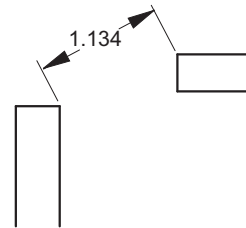

### ***Oblique Base Line Dimension Tool***



This tool dimensions objects and spaces point-to-point or obliquely from a base point. The results shown reflect colinear dimension points.

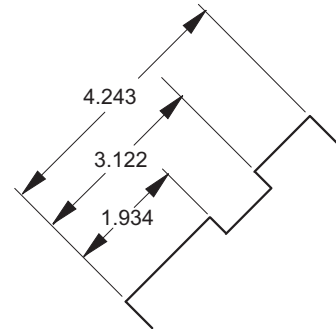

#### **Using the Oblique Base Line Dimension Tool**

1. Select the **Oblique Base Line Dimension** tool. The Message Line reads, *Oblique Base Line: Pick first dimension point*. The Message Line guides each successive step.
2. Click the base point of the geometry.
3. Click the second point. The dimension appears.
4. Click the next place for the dimension. This dimension appears to the right of the first, measured from the base point. Continue clicking all the points to be dimensioned. Drag each dimension to a new location. Dimension and extension lines automatically redraw.

Click the points in the opposite order to display the dimension on the other side of the objects.



### Oblique Chain Dimension Tool



This tool dimensions objects and spaces point-to-point, end-to-end. The results shown reflect colinear dimension points.

#### Using Oblique Chain Dimension Tool

1. Select the **Oblique Chain Dimension** tool. The Message Line reads, *Oblique Chain: Pick first dimension point*. The Message Line guides each successive step.
  2. Click the first point on the geometry.
  3. Click the second point. The dimension appears.
  4. Click the next place for the dimension. This dimension appears, measured from the last point clicked. Continue clicking all the points to be dimensioned. Drag each dimension to a new location. Dimension and extension lines automatically redraw.
- Click the points in the opposite order for the dimension to display on the other side of the objects.

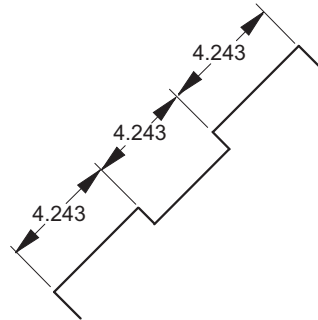

#### Tip

To access the subpalette, tear off the **Dimension** palette from the main tool bar.

## Perpendicular Dimension Tools



These tools measure an object or space perpendicular to another line. If most of the dimensions start from a line edge, use this tool to generate both horizontal and vertical dimensions.

For 3D geometry, perpendicular dimensions are created in the plane of the baseline. To access this subpalette, tear off the Dimension palette from the main tool bar.

### Perpendicular Dimension Tool



This tool dimensions an object or space perpendicular to a line.

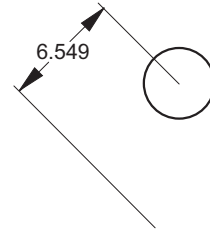

### Using the Perpendicular Dimension Tool

1. Select the **Perpendicular** Dimension tool. The Message Line reads, *Perpendicular: Pick first dimension point*. The Message Line guides each successive step.
2. Click the base line. Be certain to click *on* the base line, not on the *endpoint* of the base line.
3. Click the object or location.

The dimension appears. Drag it to a new location. Dimension and extension lines automatically redraw.

Click the points in the opposite order to display the dimension on the other side of the objects.

#### Tip

To access the subpalette, tear off the **Dimension** palette from the main tool bar.

### ***Perpendicular Base Line Dimension Tool***



This tool dimensions between a point or object perpendicular to an existing base line.

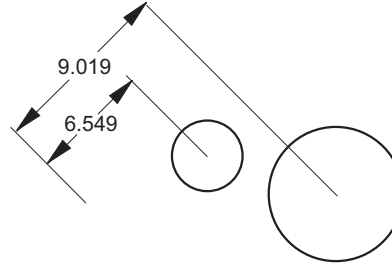

#### **Using the Perpendicular Base Line Dimension Tool**

1. Select the **Perpendicular Base Line Dimension** tool. The Message Line reads, *Perpendicular Base Line: Pick first dimension point*. The Message Line guides each successive step.
  2. Click the base point of the geometry.
  3. Click the second point. The dimension appears.
  4. Click the next place for the dimension. This dimension appears above the first, measured from the base point. Continue clicking the points to be dimensioned. Drag each dimension to a new location. Dimension and extension lines automatically redraw.
- Click the points in the opposite order to display the dimension on the other side of the objects.

### ***Perpendicular Chain Dimension Tool***



This tool dimensions between points or objects perpendicular to an existing baseline.

#### **Using the Perpendicular Chain Dimension Tool**

1. Select the **Perpendicular Chain Dimension** tool. The Message Line reads, *Perpendicular Chain: Pick first dimension point*. The Message Line guides each successive step.
  2. Click the first point on the geometry.
  3. Click the point. The dimension appears.
  4. Click the next place for the dimension. This dimension appears, measured from the last point clicked. Continue clicking all the points to be dimensioned. Drag each dimension to a new location. Dimension and extension lines automatically redraw.
- Click the points in the opposite order to display the dimension on the other side of the objects.

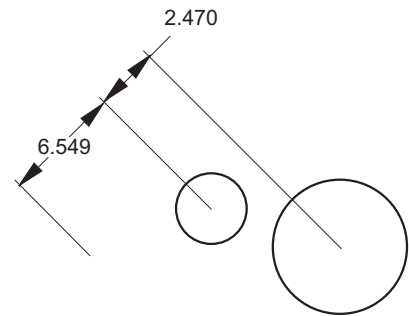

### ***Perpendicular Ordinate Dimension Tool***



This tool dimensions between a point or object perpendicular to an existing base line.

#### **Using the Perpendicular Ordinate Dimension Tool**

1. Select the **Perpendicular Ordinate Dimension** tool. The Message Line reads, *Perpendicular Ordinate: Pick first dimension point*. The Message Line guides each successive step.
2. Click the base point of the geometry.
3. Click the next point. The dimension appears, measured from the base point.
4. Click the next point for the dimension. This dimension appears measured from the base point. Continue clicking all the points to be dimensioned. To display a dimension at the base point, click the base point after having dimensioned all other points.  
Drag each dimension to a new location. Dimension and extension lines automatically redraw.

**Reminder:** To display the dimension number of the base point click both the first and last dimension points.

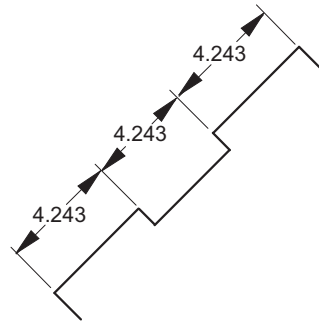

## Radial & Diametral Arrow Dimension Tools

These tools measure the radial or diameter, placing the arrow inside or outside the object as designated by the appropriate tool name.

### **Radial Arrow Out Dimension Tool**



This tool measures the radius of a circle, arc, or fillet.

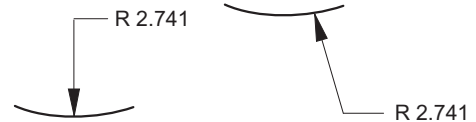

### **Using the Radial Arrow Out Dimension Tool**

1. Select the **Radial Arrow Out Dimension** tool. The Message Line reads, *Radial Arrow Out: Select arc/circle*. The Message Line guides each successive step.
2. Click near the circle, arc or fillet to be dimensioned. Click inside or outside the object depending on where the dimension should appear.

The dimension is placed for the selected object. When the dimension appears the leader line is placed at the nearest 15° increment from the location clicked. Drag the text to a new location.

For 3D geometry, radial dimensions are created in the plane of the arc or fillet.

### Radial Arrow In Dimension Tool



This tool measures the radius of a circle, arc, or fillet with the arrow inside the geometry.

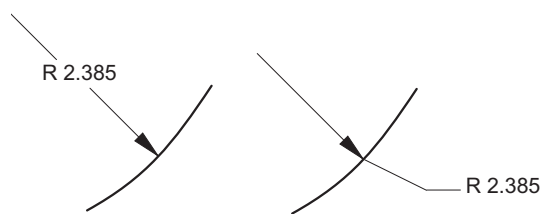

### Using the Radial Arrow In Dimension Tool

1. Select the **Radial Arrow In Dimension** tool. The Message Line reads, *Radial Arrow In: Select arc/circle.*
2. Click near the circle, arc or fillet to dimension. Click inside or outside the object depending on where the dimension should appear. Either way the arrow line starts from the arc center.

The dimension text appears for the object. The arrow line starts from the arc center. When the dimension appears, the leader line is placed at the nearest 15° increment from the location clicked. Drag the text to a new location.

For 3D geometry, radial dimensions are created in the plane of the arc or fillet.

### Diametral Arrow Out Dimension Tool



This tool measures the diameter of a circle.

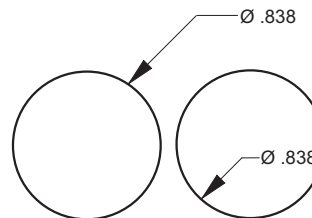

### Using the Diametral Arrow Out Dimension Tool

1. Select the **Diametral Arrow Out** Dimension tool. The Message Line reads, *Diametral Arrow Out: Select arc/circle.*
2. Click near the circle or arc to be dimensioned. Click inside or outside the object depending on where the dimension should appear.

The dimension appears for the object. When the dimension appears, the leader line is placed at the nearest 15° increment from the location clicked. Drag the text to a new location. Change the position of the arrow by dragging a selection fence around the control point at the tip of the arrow, and then dragging the arrow to a new location.

For 3D geometry, diametral dimensions are created in the plane of the circle.

### ***Diametral Arrow In Dimension Tool***



This tool measures the diameter of a circle.

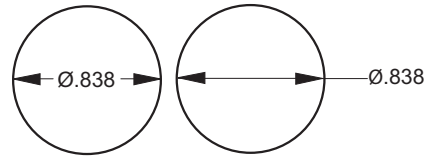

### **Using the Diameter Arrow In Dimension Tool**

1. Select the **Diametral Arrow In Dimension** tool. The Message Line reads, *Diametral Arrow In: Select arc/circle.*
2. Click near the circle or arc to be dimensioned. Click inside or outside the object depending on where the dimension should appear.

The dimension appears for the object (depending on the circle and font size). When the dimension appears, the leader line is placed at the nearest 15° increment from the location clicked. Drag the text to a new location.

For 3D geometry, diametral dimensions are created in the plane of the circle.



## Additional Dimension Tools

### Angular Dimension Tool



This tool measures the angle between two lines.

#### Using the Angular Dimension Tool

1. Select the **Angular Dimension** tool. The Message Line reads, *Angular: Pick first line*. The Message Line guides each successive step.
2. Click on the first line near the endpoint from which the angle is measured.
3. Click near the endpoint of the second line.

The inside angle is measured between the lines. The smaller angle is used.

The angle between the endpoints of the lines is measured so that it is necessary to only click near the end points, not exactly on them. Graphite interprets all mouse clicks left of the line midpoint as the left endpoint and all mouse clicks right of the line midpoint as the right endpoint.

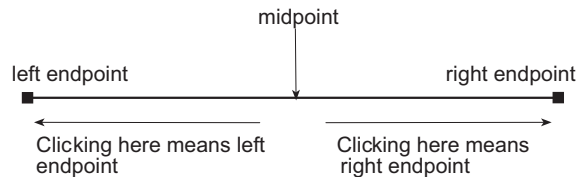

When dimensioning intersecting lines it is important to not confuse the intersection with the midpoint of the lines.

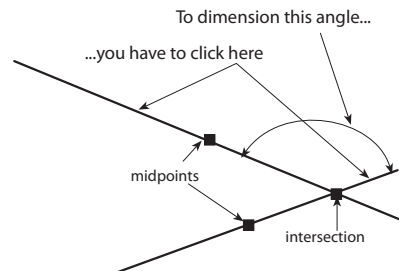

If the lines don't meet, the angle is measured from the invisible extension of the lines. The extension appears as part of the dimension.

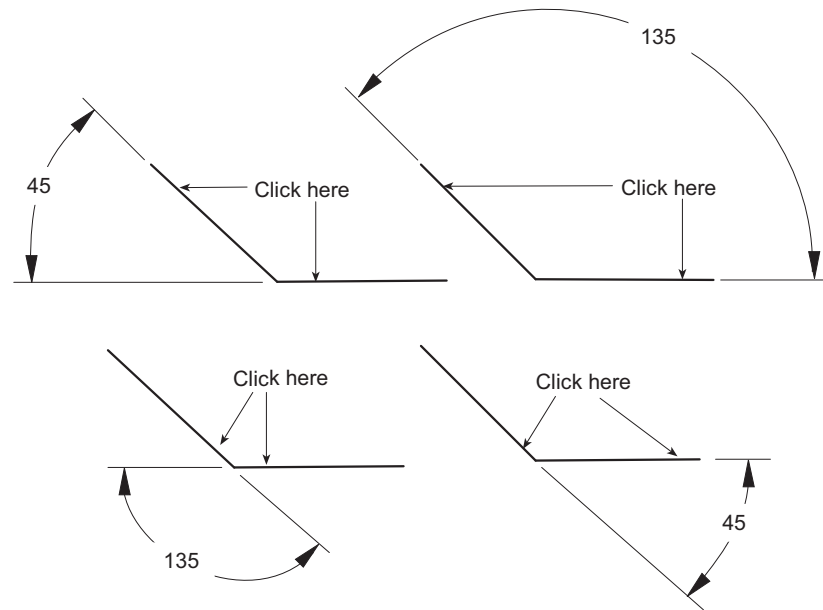

When the dimension text appears, drag it to a new location. When releasing the mouse button, the dimension and extension lines are redrawn.

Angular dimension displays all angles properly if the angles are larger than 3 degrees. For smaller than that, build the dimensions manually using lines and text objects.

The **Angular** Dimension tool does not dimension angles over 180°.

For 3D geometry, Angular dimensions are created in the plane of the two lines.

### Arc Length Dimension Tool



This tool measures the length of an arc.

#### Using the Arc Length Dimension Tool

1. Select the **Arc Length Dimension** tool. The Message Line reads, *Arc Length: Pick start point on the arc.* The Message Line guides each successive step.
2. Select the start point.
3. Select a point on the arc.
4. Select the opposite end of the arc.

Drag the text to the desired position.

The **Arc Length Dimension** tool does not put witness lines perpendicular to the arc for angles less than 180 degrees.



### Circle Center Line Dimension Tool



This tool creates a center line for any circle being created. It also optionally displays a thread symbol with the center line.

#### Using the Circle Center Line Dimension Tool

1. Choose the **Circle Center Line** tool. The Message Line reads, *Circle Center Line: Select circle.*
2. Click on the circle with the tool.  
Pressing the CTRL (Windows) or the OPTION (Macintosh) key while clicking on the circle adds a thread symbol.
3. In the Axis overlap data field of the Status Line, enter the desired axis overlap.
4. Press the ENTER (Windows) or the RETURN (Macintosh) key.

A circle center line with an optional thread symbol is added to the circle with the specified overlap.

The Status Line sets the Axis overlap.

Axis Overlap

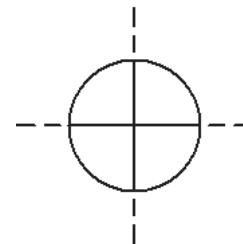



### Balloon Dimension Tool

This tool attaches a balloon symbol to geometry in the location clicked.

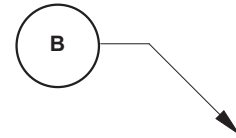

### Using a Balloon Dimension Tool

1. Select the **Balloon Dimension** tool. The Message Line reads, *Balloon: Pick geometry to point to.* The Message Line guides each successive step.
2. Click the point on the geometry for the dimension arrow.
3. Click the second point to specify the location of the balloon. The balloon symbol appears.
4. Enter the text and frame width in the Status Line data fields. Press ENTER (Windows) or RETURN (Macintosh) to update the dimension.

Move the dimension by dragging the text to a new location.

Balloon dimension text does not increment while placing additional balloons. Enter specific text in the balloon dimension, if necessary.

The Status Line contains Text and Width data fields.2

Text #  Width

## Dimension Appearance

Graphite automatically creates dimensions according to ANSI Y14.5, DIN, ISO or JIS standards. Many companies and individuals, however, have developed their own standards. The commands in the Dimension menu control virtually every aspect of the dimension appearance, without having to construct dimensions manually and while retaining the associativity of Graphite's *smart dimensions*.

Settings made in the Dimension menu affect the currently selected dimension and all future dimensions.

### Linear Dimensions

#### *Fractional Display or Decimal Display*

To change the current linear appearance of the dimensions, first change the precision setting in the Units dialog box.

Choose **Layout>Preferences>Units**. In the Units dialog box, change the Precision to a decimal or fractional option by holding down the mouse button on the arrow to the right of the data field and scrolling to the desired precision. That precision is now displayed in the Status Line data fields.

Graphite still calculates out to sixteen decimal places, however, the Status Line displays the nearest fraction or decimal to the calculated value based on the precision selected.



#### *Tip:*

To change from decimal to fractional dimensions use **Layout>Preferences>Units**.

### ***Linear***

This command in the Dimension menu sets the precision of the dimension's nominal value, and the format of its tolerance and limits. Dimensions may be shown as either decimals or fractions, as designated in the Preferences settings. The default is decimals with three decimal places (or x/16 if set to fractions) with no tolerance or limits.

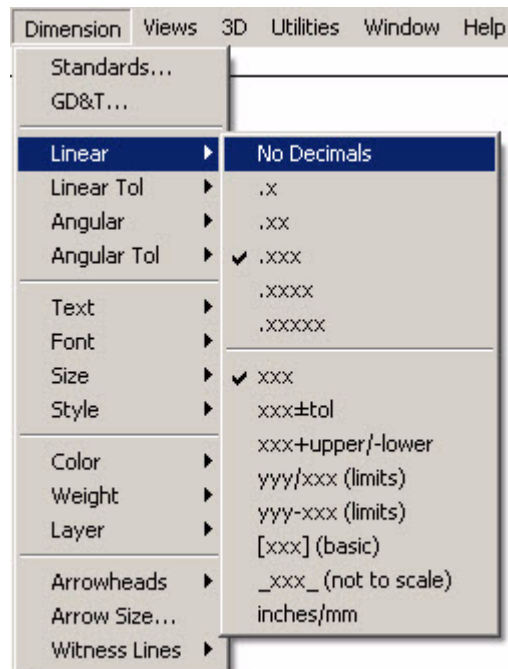

## Dimension Tolerance

The following graphic shows the appearance of each tolerance format, the limits shown in the Status Line below are entered.

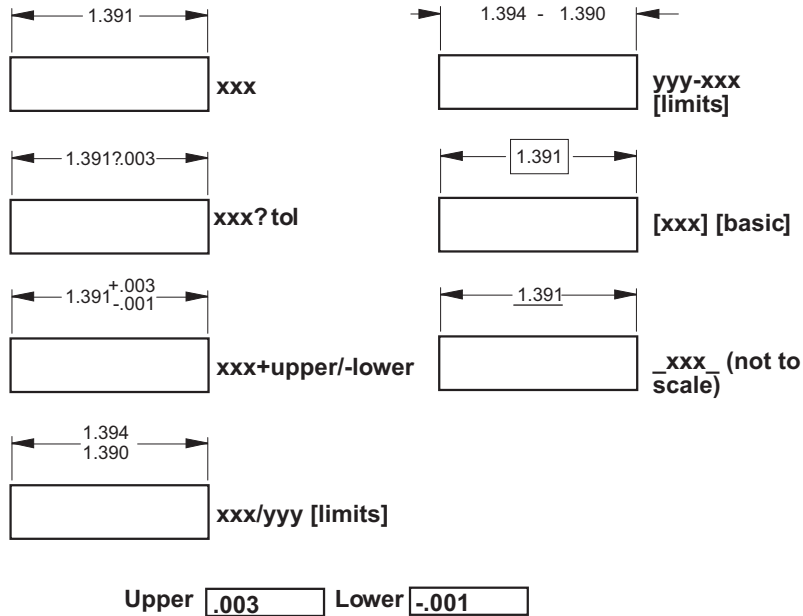

## Dual Dimensioning

Dual dimensioning displays the dimensions in both inches and millimeters by selecting the **inches/mm** under **Dimensions>Linear**.



### ***Linear Tolerance***

The *Linear Tolerance* command in the Dimension menu sets the precision of a linear dimension's tolerance values.

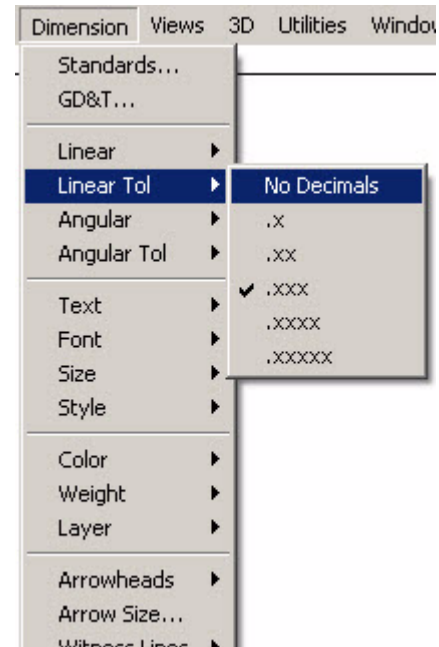

## **Angular Dimensions**

### ***Angular***

The *Angular* command in the Dimension menu sets the format for Angular dimensions.

It is possible to set degrees, minutes and seconds as well as the tolerance and limits for these dimensions.

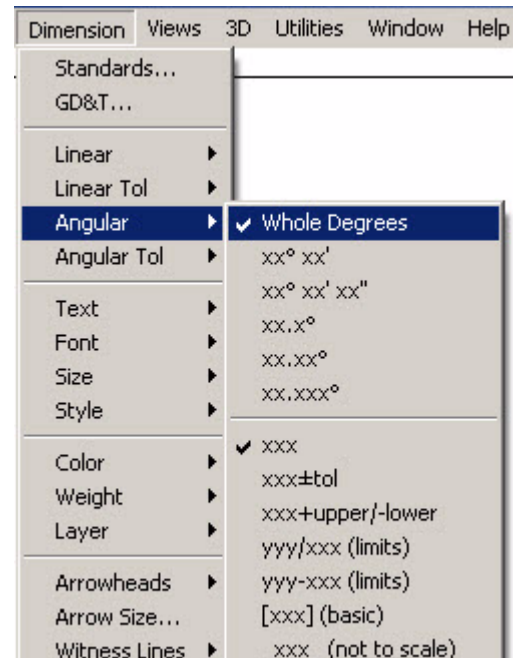



The default format is degrees with no minutes or seconds and no tolerance or limits. The graphic here shows the appearance of each tolerance format as if entered with the limits shown in the Status Line.

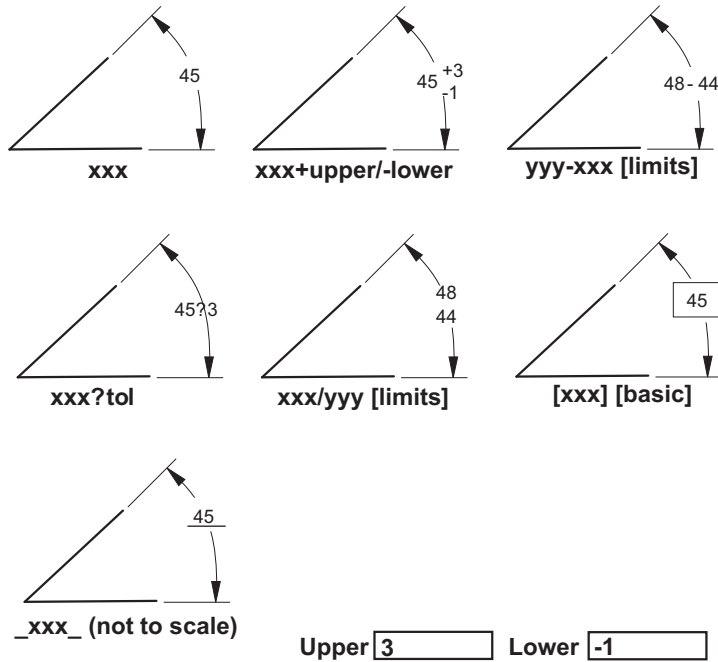

**Tech Note:**

Use the [xxx] (basic) format to create dimensions for GD&T symbols.

**Angular Tolerance**

The *Angular Tolerance* command in the Dimension menu sets the precision of an angular dimension's tolerance values.

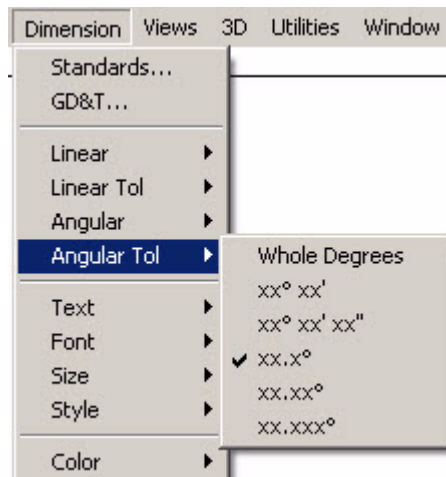

## Text Characteristics

Characteristics set here affect dimensions only. To change the style of text within text boxes, use the Text menu.

### Text

The *Text* command in the Dimension menu specifies the position and orientation for dimension text.

The default is *Horizontal* text. The *Break-in*, *Over* and *Under* options produce text that is aligned with dimension leader lines. *Over* and *Under* display text above or below leader lines, while *Break-in* places the text between leader lines.

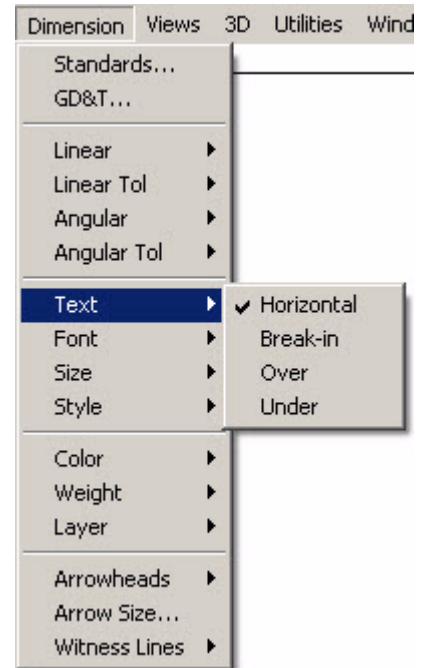
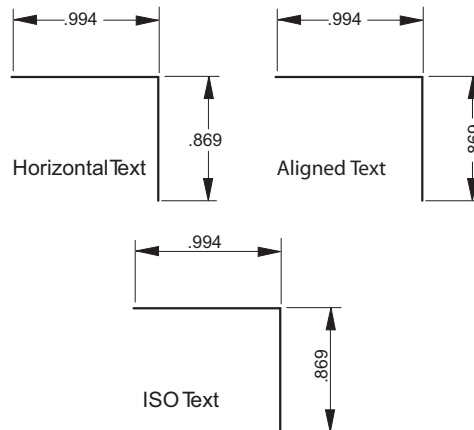

## Font

The *Font* command in the Dimension menu picks the font for dimension text. The fonts in this list are the same as those available in the Font submenu from the Text menu.

Windows: additional fonts are accessed by choosing the *More* command.

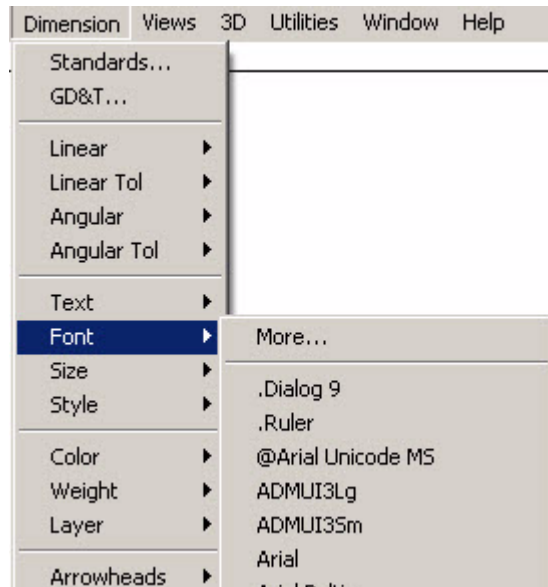

### Tech Note:

The *Font* command only affects dimensions. To change the font of other text objects, choose **Text>Font**.

The Font submenu in the Text menu has no effect on dimensions. Use the *Font* command from the Dimension menu to specify the font for dimension text.

## Size

The *Size* command in the Dimension menu picks the size of dimension text only. The sizes in this list are the same as those available in the Size submenu from the Text menu.

Selecting the *Other* option specifies a non-standard font size for dimension text.

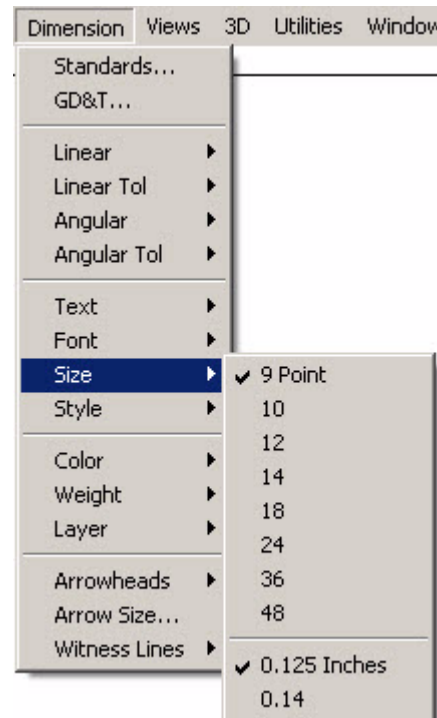

### Tech Note:

The *Size* command only affects dimensions. To change the size of other text objects, use *Edit Objects* or the Size submenu from the Text menu.

The size submenu from the Text menu has no effect on dimensions.

**Tech Note:**

The *Style* command only affects dimensions. To change the style of other text objects, use the Style submenu from the Text menu.

The Style submenu from the Text menu has no effect on dimensions.

**Style**

The *Style* command in the Dimension menu designates the style of dimension text. The styles in this list are the same as those available in the Style submenu from the Text menu, however, the settings here do not affect those in the Text menu.

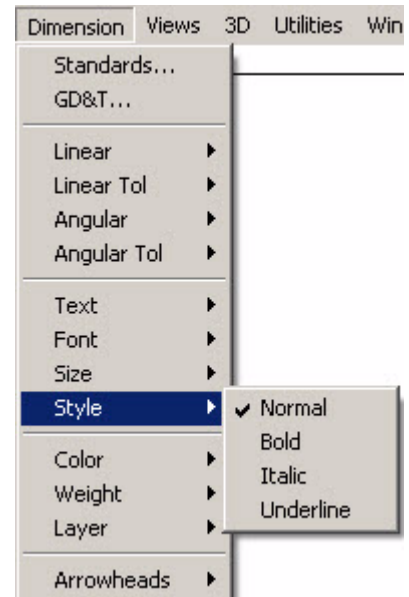
**Other Characteristics****Tech Note:**

The *Color* command only affects dimensions. To change the color of other objects, use *Edit Objects* or the Color submenu from the Pen menu.

The Color submenu from the Pen menu has no effect on dimensions.

**Color**

The *Color* command in the Dimension menu sets the color of the dimension.

The default color is blue.

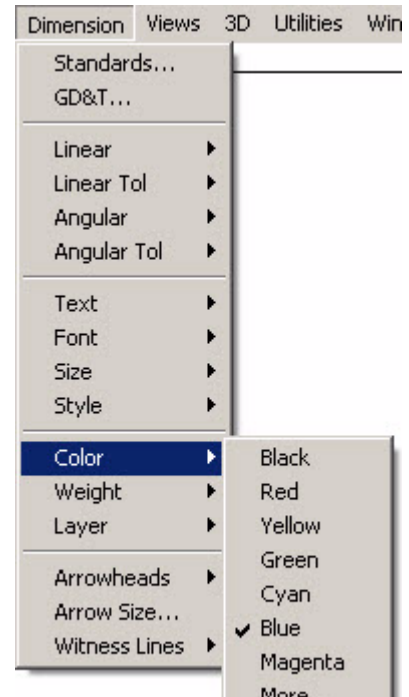

## Weight

The *Weight* command in the Dimension menu specifies the weight of dimension lines. Dimension lines are typically drawn in the thinnest weight available. For Graphite, that is 0.002" or 0.05mm.

The default weight is 0.002" or 0.05mm.

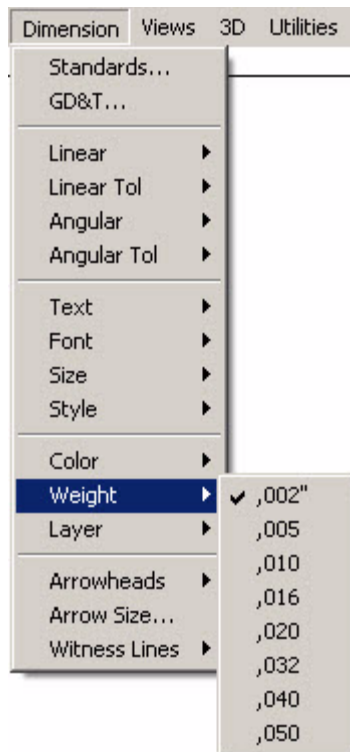

### *Tech Note:*

The *Weight* command only affects dimensions. To change the weight of other objects, use *Edit Objects* or the *Weight* submenu from the *Pen* menu.

The *Weight* submenu from the *Pen* menu has no effect on dimensions.

The values shown in the *Weight* submenu may be different if the available line weights have been changed using the *Pen Weight Editor*.

*Tech Note:*

The layers in the list will be different than the ones shown here if layers have been added or any of the default layers have been deleted.

**Layer**

The *Layer* command in the Dimension menu specifies the layer on which dimensions are placed. Dimensions can be placed on any visible layer.

The default layer is the Dimension layer. If the layer on which dimensions are to be placed is hidden or deleted, future dimensions will be placed on the current work layer.

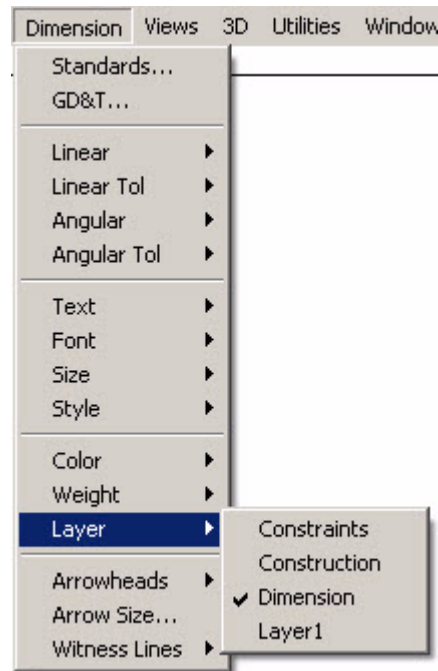

## Arrowheads

The *Arrowheads* command in the Dimension menu sets the type of arrowhead used for dimensions.

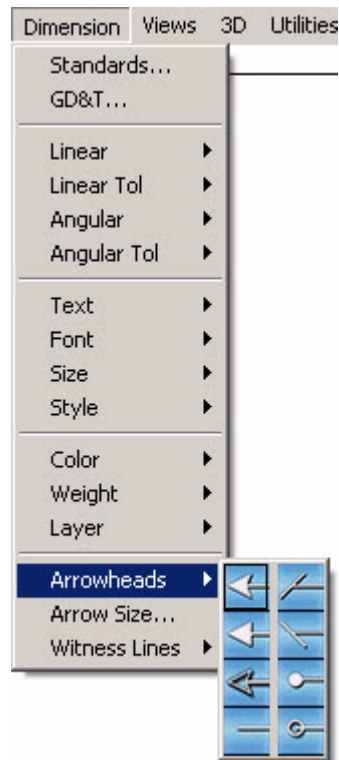

### *Tech Note:*

The *Arrowheads* command only affects dimensions. To select the arrowhead type for lines or arcs, use the Arrowheads submenu from the Pen menu.

The Arrowheads submenu from the Pen menu has no effect on dimensions.

### ***Arrow Size Command***

The *Arrow Size* command in the Dimension menu specifies the size of the arrowhead that has been selected.

- Dot Size:** Describes the diameter of circular and slash arrowheads. The value displayed is in the current units specified in the Units dialog box from the *Preferences* command.
- Length:** Describes the length of the arrowhead as the horizontal distance from its tip to the furthest extension of its base.
- Height:** Describes the height of the arrowhead as the vertical distance from its base.
- Side:** Describes the length of the edge of the arrowhead.
- Angle:** Describes the angle of the tip of the arrowhead.

By changing any value in the *Length*, *Height*, *Side*, or *Angle* entry data fields, Graphite changes the values in the other entry data fields accordingly.

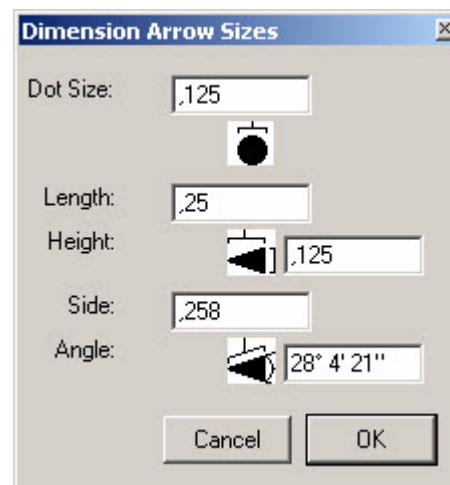



## Witness Lines

The *Witness Lines* command in the Dimension menu designates which sides of the linear dimension should have witness lines. A check mark indicates that a witness line is placed at the specified location. This option is useful for plotting a drawing that contains baseline or chain dimensions. By turning off one or more of the overlapping witness lines, the plotter is prevented from drawing multiple witness lines when only one is needed.

The *Start* of a dimension is the first point clicked. The *End* of a dimension is the last point clicked. The default settings have witness lines at both the *start* and *end* of a dimension.

This command affects only linear dimensions. Radial and diametral dimensions are not affected by the settings made in the *Witness Lines* command.

*Tip:*

Witness Lines for existing linear dimensions can also be toggled on or off in *Edit Objects*.

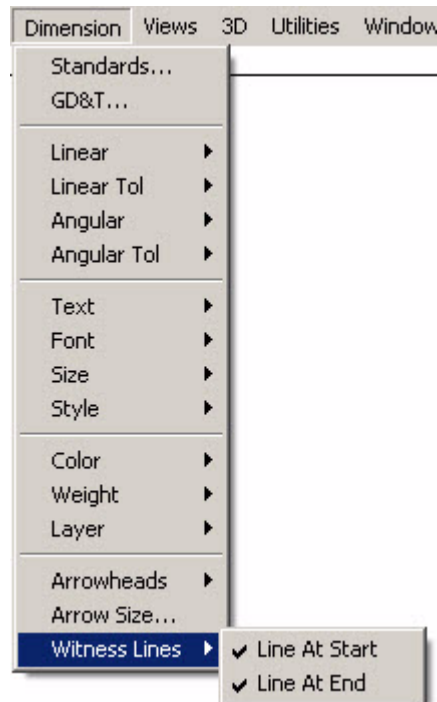

## Dimension Standards

The Dimension Preferences dialog box is opened by choosing **Dimension>Standards**. This dialog box sets the standard that the dimensions will follow, as well as defines the characteristics for the standard. Most changes made in the Dimensions Standards dialog box affect currently selected dimensions and newly created ones. Changes made to the *First Offset* and the *Next Offset* affect only newly created dimensions.

Changing the standard also changes the Dimension menu settings. Setting dimension standards saves the values in the Dimension Standards dialog box as well as the settings in the Dimension menu, except for the *Witness Lines* command.

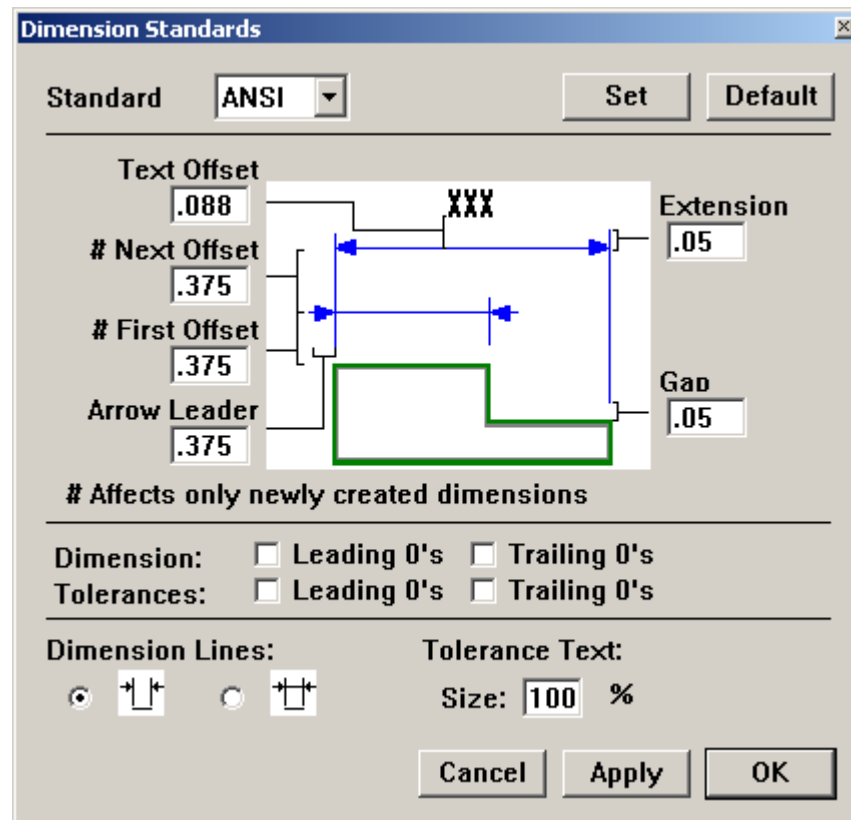

---

<b>Standard</b>	<p>Designates the standard the dimensions will follow. Graphite provides settings for ANSI, DIN, ISO and JIS standards. The Other setting in the pull down list creates custom settings or enables changes to one of the supplied standard settings.</p> <p>The Set button maps the current settings to the standard that appears in the pull-down list. It also saves all of the settings from the Dimension menu.</p> <p>The Default button reverts to the factory settings of the selected standard.</p>
<b>Text Offset</b>	<p>Sets the distance from the base of the dimension text to the leader lines. A positive entry places the text above the leader lines, and a negative value places it below the leader lines. A zero value places the text on the leader lines.</p>
<b>Gap</b>	<p>Provides the distance between the dimension point and the witness line.</p>
<b>Extension</b>	<p>Sets the distance the witness lines extend beyond the leader lines.</p>
<b>Arrow Leader</b>	<p>Sets the distance the leader lines extend beyond the witness lines when the arrow lines appear outside of the witness lines.</p>
<b>First Offset</b>	<p>Designates the perpendicular distance between object being dimensioned and the leader line and dimension text.</p> <p>Changes to this value only affect newly created dimensions.</p>
<b>Next Offset</b>	<p>Sets the perpendicular distance between subsequent leader lines created in a base line dimensioning.</p> <p>Changes to this value only affect newly created dimensions.</p>
<b>Leading 0's &amp; Trailing 0's</b>	<p>Determines whether Dimension or Tolerance values display leading or trailing zeros. Neither option is selected by default.</p>

---

Selecting Leading 0's places a 0 before all dimensions that are less than 1.

Selecting Trailing 0's places 0's after the decimal point. This option is affected by the precision set in **Layout>Preferences>Units**. Example: If the precision is set at .001, a measurement of three inches is displayed as 3.000.

These options do not apply to dimensions displayed in fractions.

**Solid Leader**

Determines whether the leader lines that appear outside of the witness lines are connected with another line. The default value does not place this line.

**Tolerance Text Size %**

Specifies the size of the tolerance text as a percentage of the nominal value. The default value is 100%, the same size as the nominal value.

Clicking OK accepts the changes made and closes the Dimension Standards dialog box. Clicking Apply affects any changes made in the Dimension Standards dialog box to any currently selected dimensions without closing the dialog box. Clicking Cancel ignores any changes and closes the Dimension Standards dialog box.

***GD&T***

See Chapter 20 for information about the U.S. government standard called Geometric Dimensioning and Tolerancing.

## Parametric Dimensions

Objects must be dimensioned in order to use the parametrics feature. Specify values, variables, or expressions for each dimension. Parametrics are discussed in detail in Chapter 16.

### Creating a Parametric Dimension

1. Create the dimension as usual.

The Status Line displays a # symbol in the text data field.

2. Enter a value (variable or algebraic expression) in the text data field.

The dimension reflects the value or variable entered, regardless of the actual value of the geometry just dimensioned.

3. Continue dimensioning as needed to define the part completely.
4. Use the parametric feature as described in Chapter 16.

### Converting Parametric Dimensions to Associative Dimensions

When bringing in a parameterized part with the *Import* command, the geometry is drawn as specified, but the dimensions display the variables and expressions which defined them as symbols. It is possible to change the dimensions to be associative so that they reflect the actual measurements of the geometry, even if the geometry is changed.

1. Select the dimensions.
2. Choose **Edit>Edit Objects**.
3. Enter a # in the text data field.
4. Click Apply and close the dialog box.

The parametric variable changes to reflect the geometry's actual measurement.



# Viewing Geometry

This chapter describes several Graphite features for viewing geometry in the drawing in different ways. The following topics are covered:

- Zooming and Panning
- Layers
- View Displays and Detail Views
- Light Settings
- Perspective
- Views Menu

## ***Zooming and Panning***

Graphite offers several ways to change the magnification of the drawing by zooming in and out using commands, zoom tools, and strokes.

### **Zoom Commands**

*Zoom In*, *Zoom Out*, or *Zoom All* from the Arrange menu all change the view magnification of the geometry. The *Zoom Previous* command returns to the last magnification. To zoom on a particular area, use the Stroke feature or the **Zoom In** tool. Strokes are described later in this chapter.

#### ***Zoom All***

CTRL+F (Windows); ⌘+F (Macintosh)

The *Zoom All* command in the Arrange menu zooms in or out to make all objects on the drawing fill the screen, regardless of how big or small the objects are.

#### ***Zoom In***

CTRL+] (Windows); ⌘+] (Macintosh)

The *Zoom In* command in the Arrange menu zooms in on the center of the screen by a factor of two. A particular area cannot be specified for enlargement.

#### ***Zoom Out***

CTRL+[ (Windows); ⌘+[ (Macintosh)

The *Zoom Out* command in the Arrange menu zooms out from the center of the screen by a factor of two. The area of reduction can not be specified.

#### ***Zoom Previous***

The *Zoom Previous* command in the Arrange menu zooms to the previous magnification, up to five times.

*Tip:*

Use the **Zoom** tools or Stroke zoom to zoom to a particular location.



## View Control Tools



Select the appropriate zoom tool from the **View Control** tool palette.

### *Using a Magnifying Glass Tool*

With the **Zoom** tools, drag a box around an area on the screen, so only that area magnifies on the screen.

1. Select a **Zoom** tool from the tool palette.
2. With the mouse button pressed, drag a box around an area on the screen to magnify or reduce.
3. Release the mouse button.

The content of the dragged box is made visible on the screen.

### *Zoom In Tool*



The *Zoom In* tool, zooms in by the specified factor. The default factor is two. This is a visual rather than a physical change.

Click in the drawing area and that position redisplay in the center of the screen with the drawing enlarged by a factor of two.

It is also possible to drag a box around an area, so only that area magnifies.



The Status Line shows the current zoom scale. Enter a different scale and press ENTER (Windows) or RETURN (Macintosh) for the new scale to take effect.

Pressing the CTRL (Windows) or the OPTION (Macintosh) key while using this tool causes it to change to the **Zoom Out** tool.

### ***Zoom Out Tool***



*Tip:*

Toggle between Zoom In and Zoom Out using the CTRL (Windows) or the OPTION (Macintosh) key.

The *Zoom Out* tool zooms out by the specified factor. The default factor is one half. This is a visual rather than a physical change.

Click in the drawing area and that position displays in the center of the screen with the drawing reduced by one half.



The Status Line shows the current zoom scale. Enter a different scale and press ENTER (Windows) or RETURN (Macintosh) for the new scale to take effect.

Pressing the CTRL (Windows) or the OPTION (Macintosh) key while using this tool causes it to change to the **Zoom In** tool.

### ***Detail View Tool***

The **Detail View tool** is discussed further in this chapter under **View Displays**.

## Stroke Zoom

Use stroke commands to zoom in or out on the drawing. Stroke commands are useful because they don't require getting out of the current tool in order to zoom. Hold down the SHIFT+CTRL keys (Windows) or the ⌘ key (Macintosh) and drag the pointer diagonally across the screen as described below. The pointer takes on the ⌘ shape when holding down the SHIFT+CTRL (Windows) or the ⌘ key (Macintosh) keys.

### Using Stroke Zoom

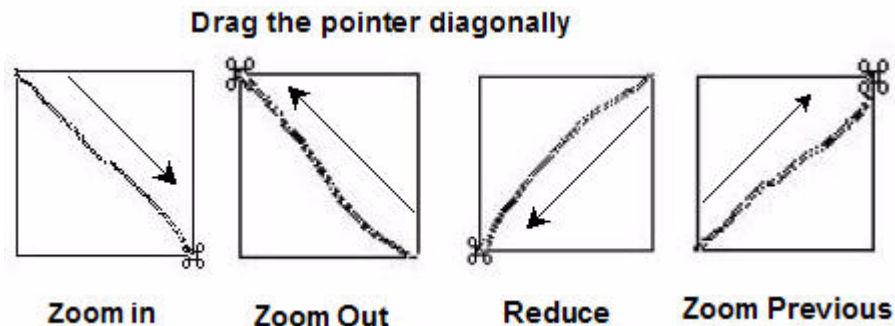

#### Drag Diagonally

*Upper left to lower right*

#### Result

Zoom-in enlargement centered over the stroked area.

*Lower right to upper left*

Reverses Zoom In stroke to the previous magnification.

*Upper right to lower left*

Zoom-out reduction of the current screen to the size of the area defined by the stroke.

*Lower left to upper right*

Reverses Zoom Out stroke to previous magnification.

**Note:** For Zoom In and Zoom Out, the size and location of the stroke rectangle is important for determining the result of the Zoom operation. For *Zoom Previous*, the size and location of the stroke rectangle is irrelevant. All cases just give the previous magnification.

## Mouse Scroll Wheel Zoom

The mouse scroll wheel zooms in and out of a Graphite drawing using the cursor as the anchor point.

### *Using the Mouse Scroll Wheel to Zoom*

To zoom in:

1. Place the cursor at the desired area to anchor the zoom.
2. Scroll the mouse button backwards.

The drawing zooms closer keeping the cursor in the same position.

To zoom out:

1. Place the cursor at the desired anchor point.
2. Scroll the mouse wheel forwards.

The drawing zooms out keeping the cursor in the same position.

## Miscellaneous Tools



The **Orbit** tool rotates the sheet camera around the 3D model. The 3D objects are fixed even if it gives the impression that they are moving. The **Pan** tool moves the sheet camera in the x and y directions. Panning past the document edges automatically scrolls the view in that direction. The **Measuring** tool displays the distance between two points.

### *Using the Orbit Tool*

1. Select the **Orbit** tool from the tool palette.
2. Drag across the screen in the desired direction to move around the geometry.  
The camera moves in increments of about 90 degrees with each stroke.

### *Using the Pan Tool*

1. Select the **Pan** tool from the tool palette.
2. Drag across the geometry in the desired direction.
3. Hold the cursor at the edge of the window for the geometry to continue scrolling in that direction.
4. Hold the cursor on the edge of the opposite window to move it back.

### ***Using the Measuring Tool***

1. Select the measuring tool from the tool palette.
2. Click the first point from which to begin the measure.
3. Click the end point.  
The distance displays in the status box at the bottom of the screen.

### **Spacebar Pan**

Use the spacebar to activate the dynamic pan tool while within any operation except text.



1. Place the cursor over the portion of the drawing to move.
2. Hold down the spacebar. The cursor changes to the hand.
3. Move the cursor in the drawing area in any direction.

The drawing dynamically moves at the same zoom level.

## ***Layers***

Layers are like pages, some transparent and some invisible. Use layers to show and hide various components of the drawing. They are particularly useful in helping to view and plot complex drawings. For example, when dimensioning a part, the dimensions can be placed on a separate layer which can be displayed or not, as required. Layers allow plotting different versions of the same document for quick and easy specialized blueprints. Some examples of their usefulness:

- Hide the dimension layer to exhibit the idea of a design to a planning team and show the dimensions when presenting the drawing to engineers.
- Hide some drawing components when printing or plotting. For example, hide the construction layer so that construction lines and geometry don't print or plot, but they remain in the drawing ready for use with design revisions. Think of visible layers as transparent pages and hidden layers as invisible pages. Although objects on hidden layers cannot be seen, they do exist. The layer must be visible for objects on it to be selected. Nor can those objects be deleted using *Select All* unless the layer is visible.
- Construct different layouts using one layer as the basis. For example, use a floor plan and then construct the electrical and plumbing plans on different layers. Then, turn off one layer (the electrical plan, for instance) and print the other (the plumbing plan) with the floor plan.

Graphite provides up to 255 visible or hidden layers in the drawing.

*Tip:*

Layers facilitate color specific wiring diagrams or electrical and plumbing blueprints.

### Using Colors with Layers

Many CAD drawings show different components in different colors. When specifying a different color for a layer, the layer remembers the color so that if geometry is added to a layer later, the new geometry appears in the same color as the last geometry constructed on that layer. In this way, the Visible pen in red can be used on one layer, green on another layer and so on.

1. Choose **Layout>Layers**.
2. Create a new layer and rename it **Outline green**, indicating that the pen style Outline with a green color will be used on this layer.
3. Make the layer, Outline green, current.
4. Select **Pen>Style>Outline**.
5. Change the pen color from Black to Green by selecting **Pen>Color>Green**.
6. Draw a circle. The circle is created with the green color.
7. Select the **Single Line** tool.
8. Make Layer 1 current.
9. Draw a line. The line is created in black (the default color for the Outline pen style).
10. Select the **Rectangle** tool.
11. Make the layer, Outline green, current and draw a rectangle.  
The rectangle is created in green.

#### Notes:

- Layers can be saved as Preferences with specified colors.
- Layers do not have an orientation or origin in Graphite.

## Layers Command

CTRL+L (Windows); ⌘+L (Macintosh)

The Layers command in the Layout menu creates, deletes, hides, shows and renames layers, as well as sets layer specifications. The work layer is the active layer, the layer on which the current construction is created.

It is not possible to hide or delete a layer that is the current (active) work layer.

It is possible to change the position of any layer in the list by drag and drop.

The visible layers are indicated in the list box by an *Eye* icon, while a check mark indicates the work layer.

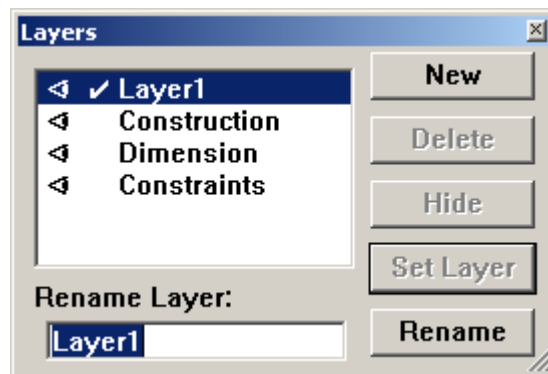

When opening a new drawing, the default layers include Construction, Dimension and Layer 1.

### Construction

This layer automatically accepts all construction lines created with stroke commands or with the Construction dialog box. All lines of the “construction” line type go on the current work layer, not this construction layer.

### Dimension

This layer automatically accepts all dimensions created with the Dimensioning tool unless another layer has been designated using ***Dimension>Layer>(Layer Name)***. Generally, the Dimension layer should be reserved for dimensions.

**Layer 1**

This is the current work layer when opening a new file. If the file only contains the default layers, all geometry is normally placed on Layer 1.

Edit any geometry or text that is visible, regardless of its layer. To make some geometry unselectable but still visible, use the *Selection Mask*. The selectability of entire layers can also be specified with the *Selection Mask*.

***Creating a New Layer***

1. Click New in the Layer dialog box to create another layer.
2. Name the layer by typing the name in the Rename Layer data field.
3. Click Rename.

There can be as many as 255 layers.

***Renaming a Layer***

1. Select the name of the layer from the list box.
2. Type the new name.
3. Click Rename.

***Deleting a Layer***

1. Select the name of the layer to delete from the list box.
2. Click Delete.

The layer and everything on that layer is deleted;

**Note:** It is not possible to delete the current work layer.

***Tip:***

It is also possible to type a name, then click New.



### ***Hiding a Layer***

1. Click the layer(s) in the list to be hidden.
2. Click Hide. The Eye icon beside the layer name disappears.

#### **Notes:**

- The current work layer cannot be hidden.
- If a layer is hidden then choosing *Select All* and deleting, the objects on the hidden layer are not deleted.

### ***Displaying a Hidden Layer***

1. Click the layer(s) to make visible in the list.
2. Click Show.

An Eye icon appears next to the layer's name in the list indicating the layers are visible.

### ***Making a Layer the Current Work Layer in the Layers Dialog Box***

1. Select the layer name from the list.
2. Click Set Layer.

The layer must be visible before making it the work layer.

### ***Relocating a Layer***

1. Click the layer you want to relocate.
2. Drag it to a new position and drop it.

### ***Changing the Work Layer with the Work Layer Indicator Box***

Use the Work Layer Indicator pop-up box at the lower left of the drawing area to specify a different layer as the work layer.

1. Press the mouse button on the box and the menu displays.
2. Drag to the layer to make it the work layer and release the mouse button.

The layer selected is now the work layer.

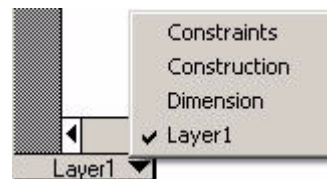

*Tech Note:*

Select a contiguous group of items in the Selection Mask by clicking on the first or last item in the desired group, then holding down the SHIFT key and either clicking on the items or dragging up or down to the other end of the desired list.

To select or deselect noncontiguous items, hold down the CTRL (Windows) or the ⌘ (Macintosh) key and click the items.

**Determining How Many Objects are on a Layer**

1. Choose **Edit>Selection Mask**.
2. Select the desired layer from those listed in the center box.
3. Choose **Edit>Select All**.
4. Choose **Edit>Edit Objects**. The number of objects is listed at the top of the Edit Objects dialog box.
5. Close the Selection Mask and Edit Objects dialog boxes.

**Layer Examples**

Layers are like transparent sheets that can be turned on and off. This feature is particularly useful for designs with several variations of a component or to reveal as much or as little detail as needed for the design. Here are two such uses.

**Floor Plans**

A common use of layers is for different floor, plumbing and wiring plans for a building. The following examples show simplified drawings using layers.

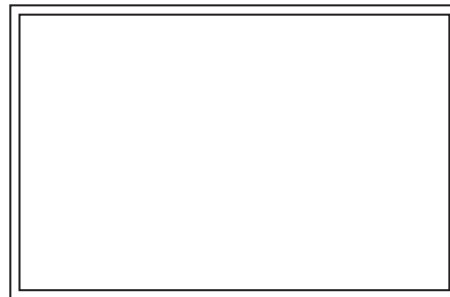

**Layer 1: The foundation**

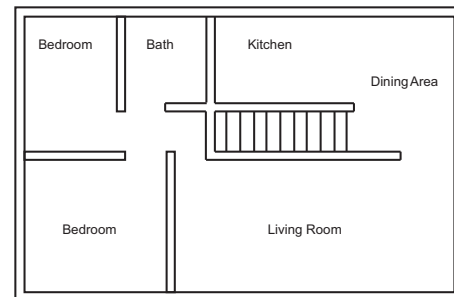

**Layer 2: First Floor**

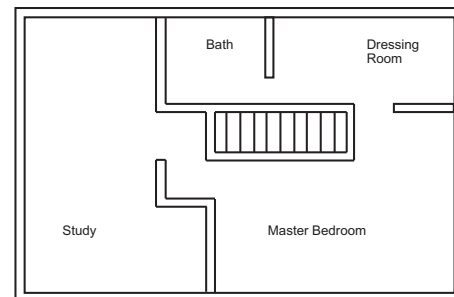

**Layer 3: Second Floor**

*Layers can be used to display different floor plans of the same building.*

In order to print or plot the layers, simply use the Layers dialog box to turn on the layers to print and turn off all other layers using the Hide or Show button. When the desired geometry is displayed on the screen, choose **File>Print**.

### Using Smart Walls with Layers

In these examples it is also possible to observe how smart walls function. The interior walls on Layers 2 and 3 overlay the exterior walls of the foundation.

Smart walls merge only on the same layer; therefore, the interior walls are not merged with the exterior walls and walls on Layer 2 are not merged with walls on Layer 3.

### Assembly

Layers can also be used to create interlocking parts of an assembly. Create one part on Layer 1 and copy the common geometry onto Layer 2. Then create the remainder of the interlocking part on Layer 2.

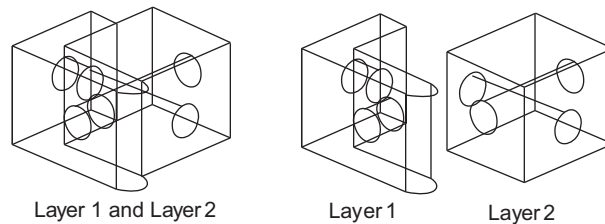

Then, turn the display of the layers on and off to present the parts appropriately.

### Layer Groups

Layer Groups are particularly useful for viewing and plotting different layers of a complex drawing. For example, the document described in the Layers section that shows the floor plan of a house might have several layers illustrating the plumbing layout and several layers illustrating the electrical plan. The plumbing layers can be shown in the Plumbing Layer Group but hidden in the Electrical Layer Group. Similarly, the electrical layers are shown in the Electrical Layer Group but hidden in the Plumbing Layer group. To create a print to go to the electrical contractor, simply make the Electrical Layer Group be the work group. This will show the layout of the house with the electrical plan contained on various electrical layers but not the plumbing information which is on the hidden plumbing layers. Rather than having to Show or Hide numerous individual layers, you only have to select a single Layer Group to get the format that is desired.

## Layer Groups Command

The *Layer Groups* command in the Layout menu extends the functionality of layers by creating Layer Groups. A Layer Group records, stores and displays layer settings, such as which layers are shown and which layers are hidden, as well as which layer is the work layer. This shows and hides different layers quickly by selecting a single Layer Group rather than setting the attributes of numerous individual layers.

The Layer Groups dialog box lists the layer groups on the left and the individual layers on the right. Visible layers for the selected (highlighted) Layer Group are indicated in the Layer list by the Eye icon, just as they are in the Layers dialog box. Visibility can be toggled by clicking the Eye icon, or at the location where the Eye icon should be for hidden layers. The work layer of the selected group is set by double-clicking on the desired layer from the Layer list. Layers that are created after a Layer Group has been defined are included in the group but are not visible.

The current set of visible layers and the work layer need not correspond to any layer group; thus, it is not necessary that a Layer Group be designated as the “work” group. Setting a work group simply changes the model’s current layer settings to those of the specified Layer Group. Also, if a Layer Group is designated the work group and layer attributes are subsequently modified, either by the Layer dialog box or by changing the work layer in the Layer Indicator pull-down list, the Layer Group loses its “work” status.

There must be at least one Layer Group created before using any of the buttons other than New, or changing any settings for any layers.

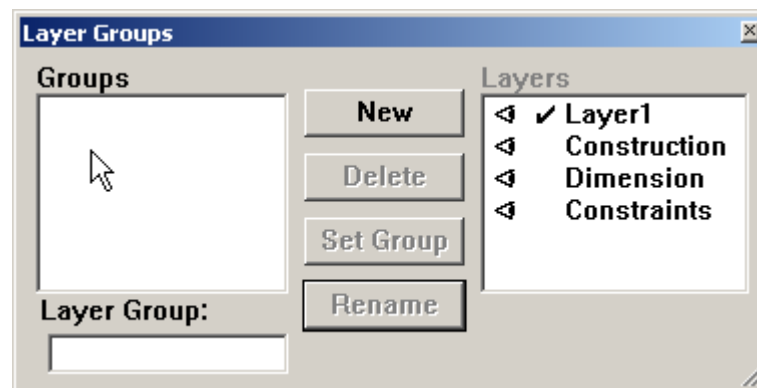

---

<b>New</b>	Creates a new Layer Group, called Group1, Group2, Group3, etc., by default. Use the Rename button to rename the Layer Group with an appropriate name. It is possible to have up to 255 Layer Groups in a single file.
<b>Delete</b>	Deletes the selected (highlighted) Layer Group. This does not delete the layers in the group.
<b>Set Group</b>	Sets the currently selected (highlighted) group as the work group. This changes the layer settings for the current model to those specified by the layer group.
<b>Rename</b>	Renames the currently selected (highlighted) group with the name in the Layer Group data field.

A check mark by a Layer Group indicates that the model's current layer settings match those of the indicated Layer Group.

### Creating a Layer Group

1. Click New.

A new Layer Group appears in the group list and is selected. It records the current layer settings and displays these settings in the Layers list. The Layers list contains all the layers present in a file.

2. Choose the layer settings.

Visible layers are indicated by the Eye icon and are hidden by clicking on the symbol. Hidden layers are made visible by clicking the location where the Eye symbol would be. The work layer is indicated by the check mark and is set by double-clicking on the desired layer.

3. Close the dialog box and the settings are retained.

To have more layer groups, repeat steps #1 and #2 before closing the dialog box.

**Renaming a Layer Group**

1. Select the desired Layer Group from the group list.
2. Enter a new name in the Layer Group data field.
3. Click Rename.

**Deleting a Layer Group**

1. Select the desired Layer Group from the group list.
2. Click Delete.

Deleting the work group, which is indicated by a check mark, deletes the group from the list, but the layer settings remain in effect until they are changed.

**Making a Layer Group the Work Group**

1. Select the desired Layer Group from the group list.
2. Click Set Group. This changes the layer settings for the current model to those specified by the layer group. These settings are shown in the layers list.

A check mark by a Layer Group indicates that the model's current layer settings match those of the indicated Layer Group.

**Changing the Layer Setting of a Layer Group**

1. Select the desired Layer Group from the group list.
2. Change the layer settings as desired. Visible layers are indicated by the Eye icon and are hidden by clicking on the symbol. Hidden layers are displayed in the layer group by clicking in the location where the Eye icon should be. The work layer is indicated by the check mark and is set by double-clicking on the desired layer. The new settings automatically replace the old settings.

**Layers, Sheets, and Models**

All Models and Sheets share the same set of layers in a file. For more information about Models and Sheets, see Chapter 14.

## View Displays

This section explains various ways to enlarge or reduce all or part of the geometry for both viewing and printing. This visual change of the view does not affect the actual measurement of the geometry in the model. This is different from the view orientation of the geometry that is set using the *Trackball* or the *View* commands in the Views menu. See Chapter 6, “Advanced Environment Settings.” There are two types of views in Graphite: the *sheet view* and the *detail view*.

### Sheet Views

The sheet view shows all of the geometric construction on the sheet outside of any existing view windows, at the scale specified. The sheet view is the default view when starting Graphite.

The sheet view is picked up by the *Sheet Camera* and projected on the current sheet. The sheet view is infinite in size, having no boundaries. In other words, when drawing on a sheet, create geometry as large as desired.

**Note:** When selecting **File>New**, Sheet 1 of the untitled file is displayed. It is the only sheet available until more are added. See Chapter 14 for more information about sheets and the Sheet Camera.

### Detail Views

In drafting, detail views are used to provide more information about a specific area of the drawing. They are typically shown at a larger scale than the original geometry. Graphite provides a tool that automatically creates detail views in order not to have to redraw the geometry.

A detail view is like a window which looks at some geometry in the drawing from a particular camera angle and displays it at a specified scale. A detail view can be created in Graphite in two different ways: with the **Detail View** tool or the *Sheet Into View* command in the Views menu. The *Sheet Into View* command is an automated way of creating arrangements of detail views in specific layouts. The detail views in each case behave in the same way.

Detail views are always placed in a view window and are associative so that when modifying geometry in any view, all views of that geometry reflect the change. There are three deliberate exceptions to this associativity, in line with standard drafting practice: dimensions, crosshatching, and text appear only in the view in which they were created.

#### *Referral:*

More about sheets and views is in the chapter 14 Advanced Viewing Techniques in this manual.

#### *Referral:*

See the next section for information on associativity.

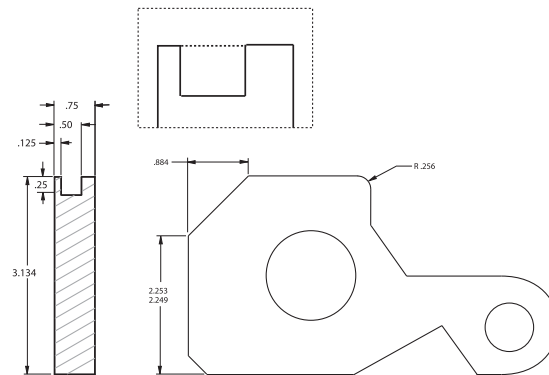

Graphite can create detail views of the drawing in which some part of the geometry is scaled and placed in a view window. In the illustration here, the detail view shows a 2 : 1 enlargement of the side notch.

Use more than one view window with different view orientations to show the various faces of the geometry. Detail view windows are useful for observing the geometry while working. They are also essential for creating finished drawings. The following graphic displays another model in four different detail views.

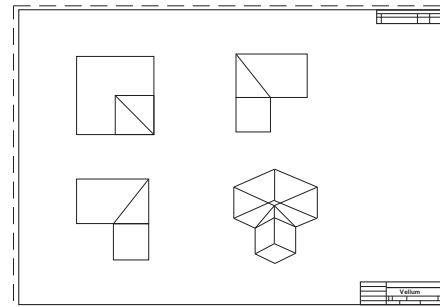



### Detail View Tool



The **Detail View** tool creates a detail of the designated area of the drawing.

#### Creating an Associative Detail View

An associative detail view is one in which a change will appear in the view if a change is made to geometry in another view.

1. In the View Control subpalette, select the **Detail View** tool. The Message Line reads, *Detail View: Enter view scale then pick first corner of viewing frame.*



2. Enter a scale for the detail view in the Status Line.



3. Use the pointer to drag a rectangle around the area of the drawing that is to be placed in the detail view. This rectangle becomes the window frame.

It is also possible to click the first corner and the opposite corner to define the view.

4. Position the pointer in the center of the detail view window frame and drag the window to a clear area on the drawing.

#### Creating a Non-associative Detail View

To have a detail view that is not associative; that is, when making changes to the original geometry, the geometry in the view does not change:

1. Create a detail view on an open space.
2. Use the **Selection** tool to click inside the view and make it active.
3. Drag a selection fence around all of the geometry inside the original view. The geometry inside the view is selected.
4. Choose **Edit>Copy**.
5. Choose **Views>Models**.
6. Click New to create a new model (by default, model 2).
7. Click Current to make the new model the current model in the new view. The geometry in the view disappears.
8. Choose **Edit>Paste**.

The geometry is pasted into the new detail view, but it is no longer associative, since it is part of a different model.

#### Tip:

It is also possible to create the view window rectangle by clicking to place the diagonally-opposite corners.

#### Referral:

Find more about Models and Views in the Chapter 14, "Advanced Viewing Techniques."

## Rotating the Viewing Area and Detail Views

It is only possible to change the view orientation within a view window. The sheet view is rigidly fixed to the sheet itself and aligned parallel to the sheet in the Top view.

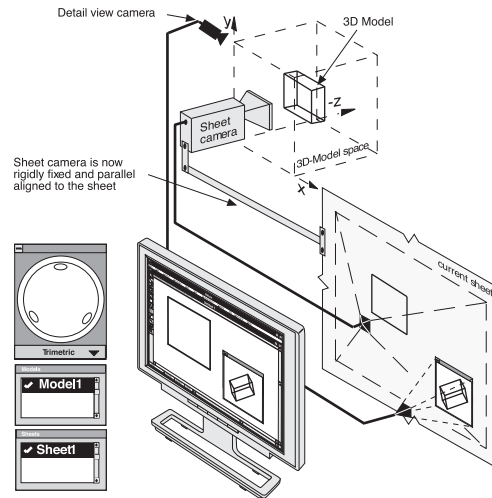

1 Model with 1 additional active Trimetric view window

## Active View

The detail view window displays a title bar only when it is the current or active view.

Click inside the detail view window when the view is inactive, as in the left graphic here. The detail view window becomes active, displaying a title bar and control button for its pull-down menu, as in the right graphic.

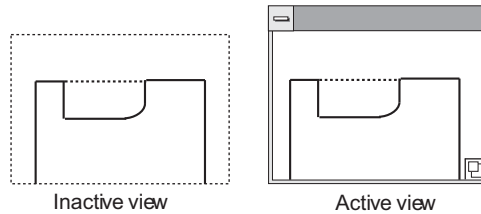

### *Tech Note:*

When clicking the detail view, the view becomes active and the view window with a title bar appears.

The sheet view is made active by clicking in the drawing area away from all detail views. In other words, all the detail views look inactive. Activate the sheet to construct geometry that is outside of a view.

A view must be active to work in it. Either a detail view is active or the sheet view is active, but only one can be active at a time.

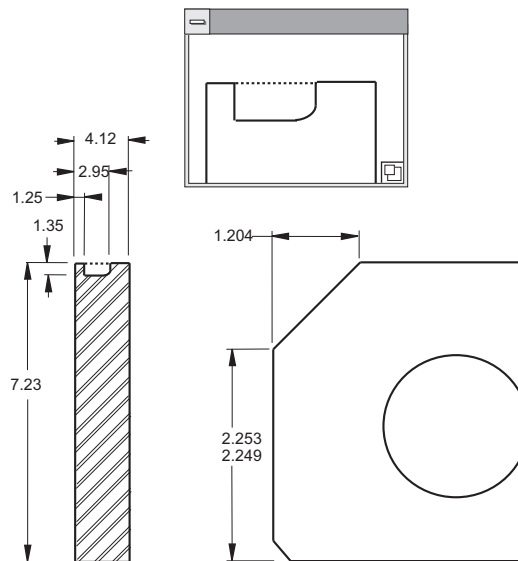

Dimensions and hatch pattern only on the sheet

## View Window

The view window includes a title bar, size box and Control pull-down menu only when the detail view is active.

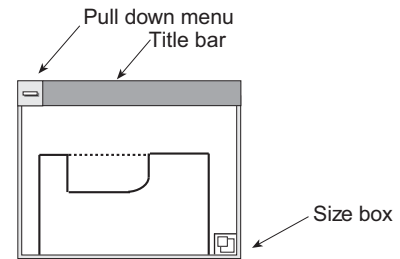

Drag the view around by the title bar and resize the window by dragging the size box.

### Control Pull-down Menu

The Control pull down menu provides options for manipulating the view.

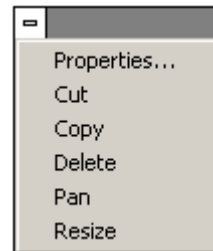

### Properties

Names the detail view, changes the view scale (entering 2 zooms into the area by a factor of 2), and defines the locations of its corners relative to the origin.

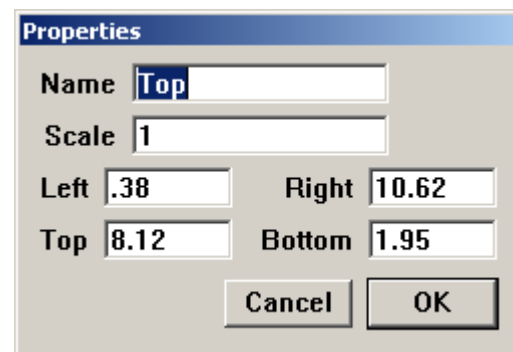

### Cut

Removes the Detail View from the sheet and places it on the Clipboard. This is useful for placing the view on a different sheet. Choose the **Edit>Paste** to paste the cut view window. This command does not cut the geometry. To cut the geometry, choose **Edit>Cut**.

#### Tech Note:

In the Graphite View window, the Control Menu in the upper left corner does not contain the standard control commands but special view window commands.

#### Tech Note:

Using *Cut* or *Copy* within the Detail View does not cut or copy the geometry inside, but rather cuts or copies the detail view itself. To cut or copy just the geometry, use these commands from the Edit menu.

**Copy**

Places a copy of the view window on the Clipboard. This is useful for pasting multiple identical views onto one or more sheets. Choose the **Edit>Paste** to paste a copy of the view window. This command does not copy the geometry. To copy the geometry, choose **Edit>Copy**.

**Delete**

Removes the active window and makes the sheet active. It does not delete geometry.

**Pan**

Moves the geometry inside the view window. A hand icon appears which is used to drag the contents of the window.

When the mouse button is released the *Pan* function ends.

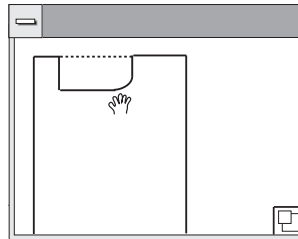
**Resize**

Drags a new view window. This function differs from dragging the window borders. With the *Resize* command, it is not necessary to change each border individually since a new window is defined that is substituted for the original one.

If the content of the view window is not seen after applying the *Resize* command, choose **Arrange>Zoom All** with the SHIFT (Windows) or CONTROL (Macintosh) key pressed. This "fits" all the geometry of that model into that view window at the necessary view scale.

*Tip:*

Scroll within a view by holding down the SHIFT (Windows) or the CONTROL (Macintosh) key while moving the scrollbars.

**Changing the View Scale**

When fitting a view or group of views in a drawing format, it may be necessary to scale a view.

1. In the detail view's Control menu, choose *Properties*.
2. Specify the scale and click OK.

**Copying a View Window**

Use the view window menu to make another view window to add to or change the arrangement selected with *Sheet Into View*.

1. Click inside the window to make it active.
2. Choose *Copy* from the view window control menu.
3. Choose **Edit>Paste**.

The copy of the window appears slightly offset from the original window. Drag it to a new location.

**Panning the Geometry in a View Window**

1. Click inside the window to make it active.
2. Choose *Pan* from the view window menu.  
The pointer changes to a hand icon.
3. Drag the geometry to the desired location.

**Zooming within a View**

1. Click inside the view to make it active.
2. Hold down the SHIFT (Windows) or the CONTROL (Macintosh) key.
3. Choose **Arrange>Zoom (In, Out, Previous, or All)**

or

Choose one of the **Zoom** tools in the tool palette.

The geometry inside the view is zoomed.

All commands from the Arrange menu work inside the view when holding down the SHIFT (Windows) or the CONTROL (Macintosh) key while choosing from the menu.

The keyboard Zoom commands are not designed to work within a view window.

## Views Menu

The view control commands in the Views menu control the active view. When there are overlapping views, think of them as a stack where only the top view is active. If the *Auto Front* command is turned on, clicking a view moves it to the top of the stack for work. This may cause some problems when an object is clicked on in the top view to select it, but an underlying view activates instead.

To remedy this situation, turn off the *Auto Front* command. Select the view to work in and choose **Views>Bring To Front**. The objects in the view brought to the front remain on top, even when clicking a different view visible in the top view's space.



### **Auto Front Command**

The *Auto Front* command in the Views menu overrides the *Bring To Front* or *Send To Back* settings. When this setting is in effect, simply click on a view to bring it to the front and make it active. When this setting is not active, it is not possible to inadvertently bring a view to the front when working on another view. This command only works for views.

### ***Bring To Front Command***

This command in the Views menu brings the specified view to the front of the stack of views.

1. Select the view.
2. Choose **Views>Bring To Front**.

This command counteracts the *Auto Front* command, so a click selects objects in the view rather than activating another view.

### ***Send To Back Command***

This command in the Views menu sends the specified view to the back of the stack of views.

1. Select the view.
2. Choose **Views>Send To Back**.

This counteracts the *Auto Front* command, so a click activates another view rather than selecting objects.

### ***Draw View Boundaries Command***

This command in the Views menu shows the boundaries of all inactive views. This boundary is printed if left displayed while choosing the *Print* command.

To print the view without boundaries, in the Views menu, deactivate Draw View Boundaries.

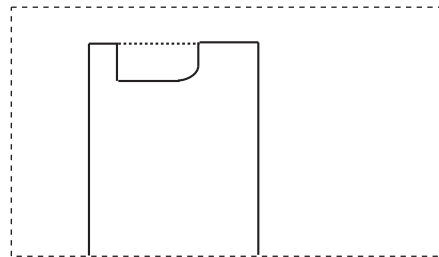

### ***Windows***

This submenu on the Views menu shows the names of all the open Graphite documents. To bring a different document to the top window, choose it from the submenu.



## Navigator Palette

The Navigator Palette easily moves through sheets and layers in a circular file fashion. It displays the active documents and isolated layers.

To display the Navigator palette, choose **Utilities>Show Navigator**.

### Sheet Navigation



Click on the **S>**  button to move forward through the visible

sheets. Click on the **S<**  button to move backward. Only one sheet at a time can be shown.

### Layer Navigation

Click on the **L>**  button to move forward through the visible

layers. Click on the **L<**  button to move backwards.

Click on the **L+**  to show all layers. Clicking **L^**  pops up a list of available layers. Choosing one of the layers makes it the active layer and all other layers are visibly turned off. Restore full visibility to all layers by clicking on the

 **L+** button or choosing **Layout>Layers** and setting the visibility individually.

### Window Navigation

Click on the **W**  button to display a popup menu of open Graphite documents. Choosing one of the documents makes it the active document.





# Advanced Viewing Techniques

Sheets, views and models are features in Graphite that add a great amount of flexibility to the design process. This chapter explains each of them and how they interact with each other. The following topics are included:

- Sheets
- Models
- Views, including Sheet into View and View Layouts
- Combining Sheets, Views and Models

## Sheets

A sheet is an infinite planar area. Graphite allows multiple opaque sheets within a drawing. A drawing can be a simple part or a complex assembly, with related geometry organized on as many sheets as the scope of the project demand.

There can be many sheets but only one sheet is active, and therefore, visible at a time. To activate a sheet use the *Current* command in the Sheets dialog box in the Views menu. In Graphite one sheet is always the active sheet which cannot be deleted.

Having multiple sheets, imagine them arranged as a stack of sheets behind the computer screen. To make a sheet current bring it to the front. That is why only one sheet, the current sheet, can be seen at a time.

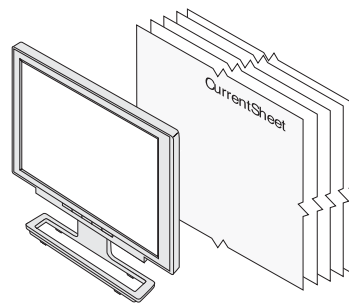

Multiple sheets are stacked behind the screen. The current sheet is always in front and the only visible one.

## Using Sheets

Every document contains *Sheet 1*. Use the *Sheets* command in the Views menu to create new sheets, delete, rename, or set the current work sheet. Give the sheets distinctive names, rather than their default numbers, because it is much easier to know what's on a sheet if it's named, for instance, Detail View, rather than Sheet 2.

Sheets are Graphite's equivalent to pieces of paper, with the added function that Sheet 2 can display geometry associated with Sheet 1. When using detail views, layers won't serve your needs for printing or plotting. This is because when the layer containing the geometry that the detail view is associated with is hidden, the geometry is also no longer visible in the detail view.

Use sheets to display and print multiple pages of complex drawings. The following example explains the process:

- When opening a new document, Sheet 1 displays in the drawing area.
- Create a complex assembly and a detail view on Sheet 1.
- When it is time to plot the project, the assembly is found to fill all of the plotting area and there is no room for the detail view on the page.
- Select the detail view and choose *Cut* from the active View window menu (not from the Edit menu in the menu bar).
- Choose **Views>Sheets** and click New to create another sheet (Sheet 2).
- Click Current to make Sheet 2 the current sheet.

A blank sheet displays.

- Choose **Edit>Paste** to paste the detail view on Sheet 2.

The detail view displays on Sheet 2.

Use *Zoom All* in order to see the detail view.

Finally, check to see that the detail view is still associated with the original assembly:

- Make Sheet 1 current and make a change to the area of the assembly that is in the detail view. (Remember: Crosshatching, Text, and Dimensions are not associated in a detail view.)
- Look at Sheet 2 and see that the change appears in the detail view on Sheet 2 and, of course, changes made in the detail view are also be reflected in the Sheet 1 view.

### **Sheets Command**

The *Sheet* command in the Views menu facilitates creating and naming sheets, and setting the work sheet. The check mark in the list of sheets indicates the current work sheet. The title bar for the document also indicates the active sheet (Document Name: Sheet Number). The name of the sheet only displays in the Title Bar if more than one sheet exists.

*Tip:*

To print a part related to one project separately, create a new sheet.

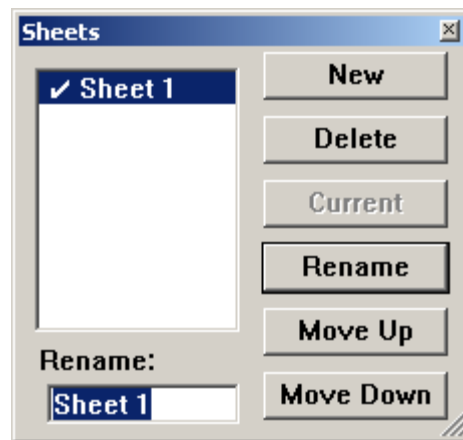

Use several sheets to create related components and associated detail views. Using a new sheet in Graphite is like using a fresh sheet of paper on a drafting board to create a component related to the larger project.

*Tip:*

It is also possible to create a new sheet by typing a sheet name and then clicking New.

**Creating a New Sheet**

Click New to create another sheet. Name the sheet by typing the name in the Rename data field and clicking the Rename button.

**Note:** Graphite automatically creates a new model when creating a new sheet. See a later section for more information on models.

**Renaming a Sheet**

1. Select the name of the sheet from the list box.
2. Type the new name.
3. Click Rename.

**Deleting a Sheet**

1. Select the name of the sheet from the list box.
2. Click Delete.

Graphite handles Models and Sheets separately. The geometry created is the model. What you see on the sheet is only an image (view) of that model. So when the sheet is deleted only the *Sheet View* or *Detail View* of the model is deleted, but not the geometry (model) itself.

**Note:** The current sheet cannot be deleted.

**Selecting the Current Sheet**

1. Select the name from the list.
2. Click Current.

## Models

Models are composed of the geometry you create. Even if it looks like the geometry is created directly on the sheet, it is not. What is seen on the sheet is only an image of that model. The model itself is created in an infinite three-dimensional area we call Model space.

### Projected Model Image

The image on the sheet is the projected sheet view of the model picked up by the *sheet camera* which is aligned parallel to the sheet and looking from a top view, at the model.

When the *Zoom* commands in the Arrange menu or the **Zoom** tools from the tool palette are used, it changes the view scale of the model by zooming the sheet camera like a video camera.

### Multiple Models

There are two different ways to create models:

- Using the *Sheets* command in the Views menu.
- With the *Model* command in the Views menu.

When creating a new sheet, Graphite automatically creates a new blank model where geometry can be created.

#### Tip:

Any combination of geometry such as lines, arcs, circles, dimensions, text, etc. created using the tools in Graphite is a model.

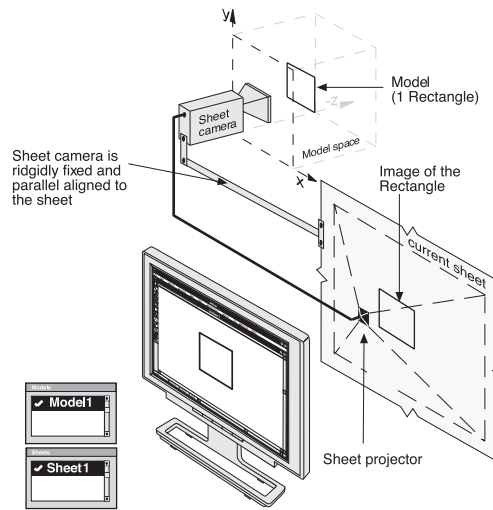

Model1 projected on the current Sheet

#### Tech Note:

The *Sheet Into View* command also creates a new model for the sheet view. The existing model is placed in the detail view window. See a later section of this chapter for more information.

### Creating a New Model with the Sheets Command

This task assumes that any additional models and sheets are not created.

1. Select **Views>Sheets**.

The Sheets dialog box displays.

2. Select **Views>Models**.

The Models dialog box displays.

3. Since the Model dialog box is placed at the same location on the screen, move it to another location to see both dialog boxes.

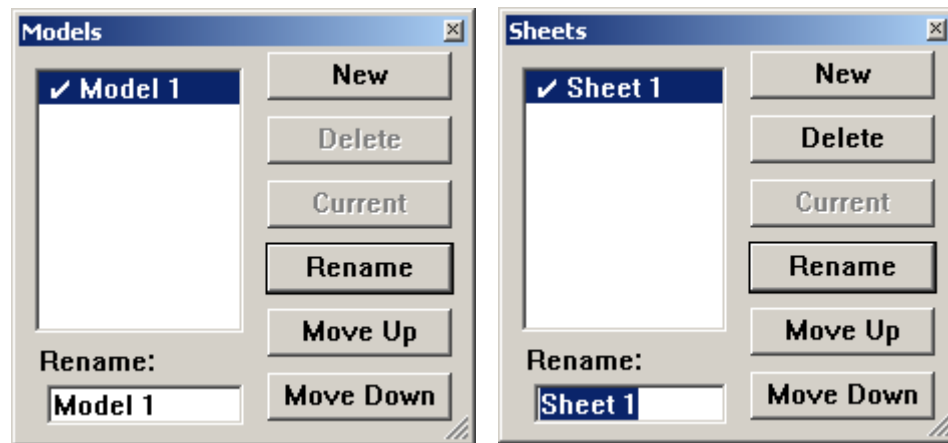

A new drawing in Graphite has one Sheet and one Model by default. The check mark in each dialog box shows that Sheet 1 and Model 1 are current.

4. Display the Sheets dialog box and click New to create a new sheet. A new model automatically appears in the Models dialog box (Model 2).
5. Make Sheet 2 current by highlighting it and clicking Current.

Any geometry on Sheet 1 disappears and a blank screen comes up. Also, the check mark moves from Sheet 1 to Sheet 2 and the check mark also moves automatically from Model 1 to Model 2.

Model 2 automatically becomes current because Sheet 2 is related to Model 2. So if you make Sheet 2 current on the screen, then Model 2 has to be current as well.

Sheet 2, now displayed on the monitor, is blank because nothing has yet been added to Model 2. As soon as the drawing is begun, all geometry automatically adds to Model 2 since Model 2 is the current model space.



## Relationship between Sheets and Models

When a new model is created with the *Model* command, it is created without creating a new sheet. So it is possible to have more models than there are sheets. It is only possible to look at one model at a time in any view (sheet view or detail view) if the geometry is contained in different model spaces (i.e. Model 1 or Model 2). Think of models as a spatial area where geometry is located. Two spatial areas cannot be viewed through one window at the same time.

It is possible to create more models than there are view windows. It is also possible to have a model that is not displayed in any view. And a single model can be displayed in many views at the same time.

Making a model current in a sheet view is like moving the sheet camera moved to the new model. Making a sheet current, is like moving the sheet camera to the related model whose image is projected on that sheet.

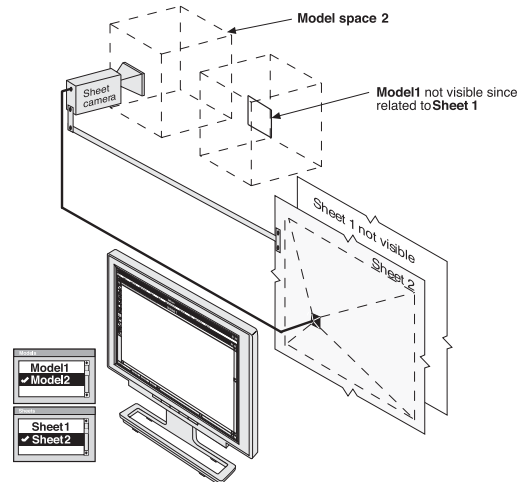

The **Sheet camera** moves automatically to **Model 2** when **Sheet 2** is made **current**

### Models Command

The *Models* command in the Views menu specifies models and switches between models, projecting them on the current sheet. It is possible to display a single model on more than one sheet, but only one model can be viewed at a time on each sheet without using detail views.

### Creating a New Model

Click New to create another model. Name the model by typing the name in the Rename data field and clicking Rename.

#### Tip:

It is also possible to create a new model by typing a model name and then clicking New.

**Renaming a Model**

1. Select the name of the model from the list box.
2. Type the new name.
3. Click Rename.

**Deleting a Model**

1. Select the name of the model from the list box.
2. Click Delete.

When deleting a model, all of the geometry making up that model is deleted.

**Note:** The current model cannot be deleted. A model which is still associated with a sheet cannot be deleted. As long as it is related to a sheet the Delete button in the Models dialog box is not available.

**Making a Model the Current Model**

1. Activate the view (sheet view or detail view) by clicking on it.
2. Select the name from the list in the Models dialog box.
3. Click Current. A check mark shows the current model for the current view.

### ***Multiple Sheets and Models***

Generally, a model is created on a single sheet. When it is time to create drafting views of the model, it may be necessary to have several sheets because the model is so large or so detailed that it requires more than one sheet of paper for the finished drawing.

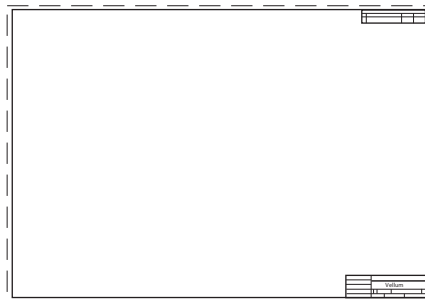

**First page — Sheet 2  
particular format**



**Second page — Sheet 2  
less detailed format**

For example, designing a dental workstation, place the view on one page showing the chair, work tray, x-ray and drill arms.

Then on subsequent pages, add the detail views of the x-ray arm and drill setup. In addition to this, the first sheet would use a particular format and the following sheets would use a different, less detailed drawing format.

## Using Multiple Sheets

The key to using more than one sheet of paper is to use Graphite's model and sheet functions. In the example below, start with the front view of a model (Model 1) on a drawing format (Model 2) on Sheet 1. Then open Sheet 2 and display all four views of Model 1 on it.

1. Create the part.

Model 1 contains the part and its Top view is picked up by the sheet camera and displayed on Sheet 1.

2. In the Views menu, use the *Sheet Into View* command to set up four views in the appropriate sized drawing format.

The sheet camera aligns parallel to the current sheet and displays the Top view of Model 2 (the drawing format) on Sheet 1. Four detail view cameras display 4 views of Model 1 on Sheet 1 within the drawing format.

3. Use the *Cut* command in the view window menu to remove all the view windows, except the Front view.

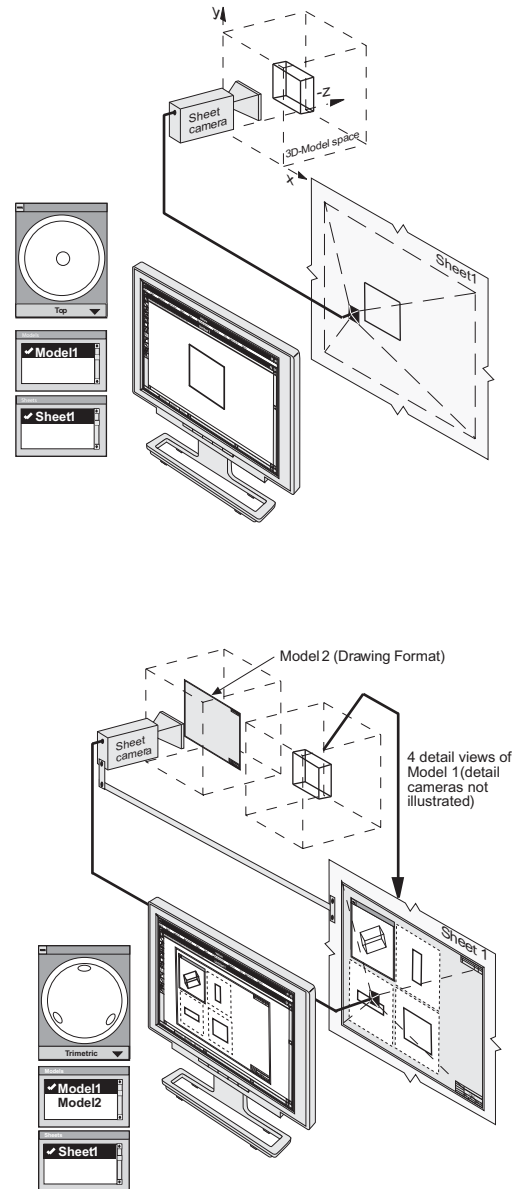

4. Resize the remaining Front view window so that it fills the drawing format.

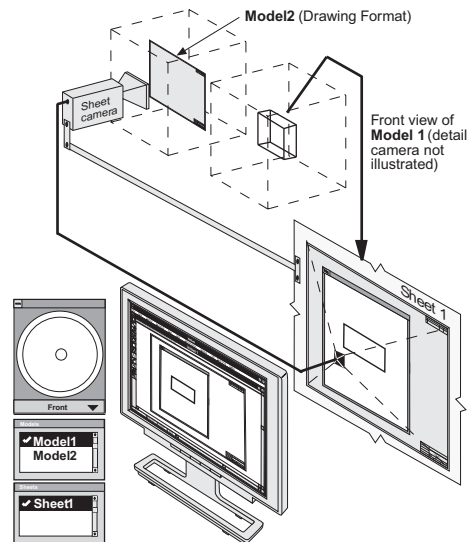

5. Choose **Views>Sheets**.  
The Sheets dialog box displays.
6. Click New.  
Sheet 2 displays in the Rename box.
7. Click Current.

Sheet 2 with the blank Model 3 displays in the drawing area.

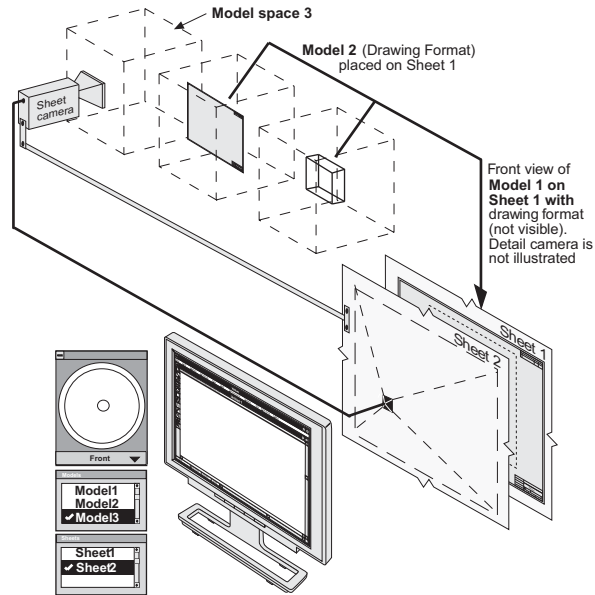

8. Choose **Views>Models**.

The Models dialog box displays. The blank Model 3 is the current model automatically created with Sheet 2, picked up by the sheet camera and displayed on Sheet 2.

9. Click Model 1 and click Current.

Model 1 is picked up by the sheet camera and displayed on the second sheet.

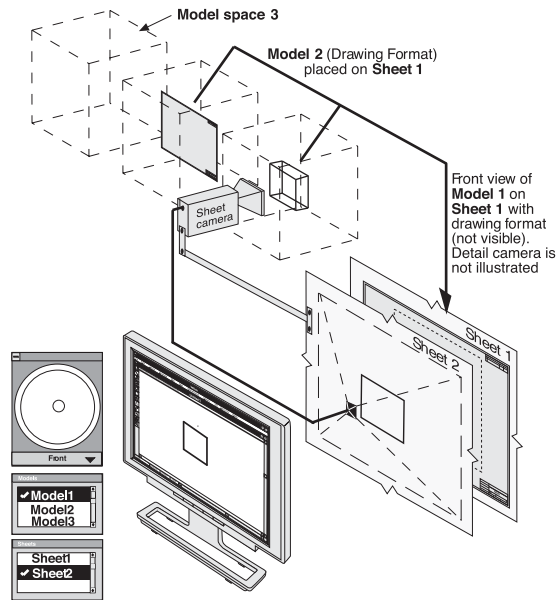

10. (Optional) Delete Model 3 since it is no longer needed. Model 3 was automatically created with Sheet 2.

Another possibility is to leave Model 3 active and paste the views of Model 1, which were removed with the *Cut* command at the beginning of this exercise, on Sheet 2.

11. Choose **Views>Sheet Into View** and select the appropriate format and views.

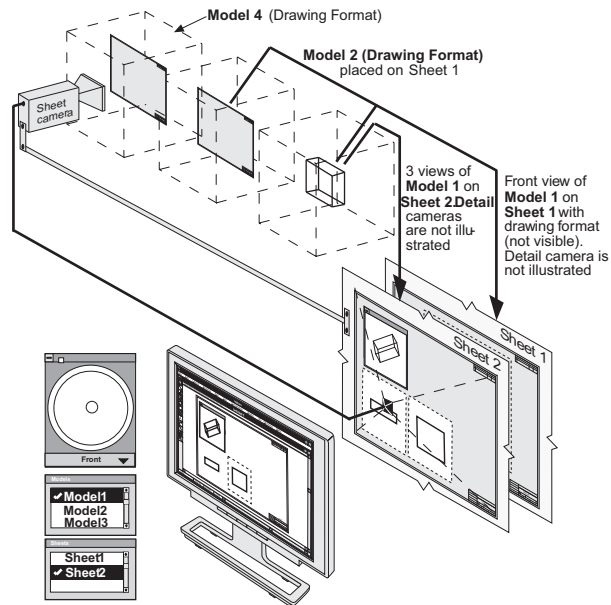

With the *Sheet Into View* command, place views from the current Model 1 on the current Sheet 2. The sheet camera moves to Model 3, which was automatically created with *Sheet Into View* and displays the appropriate drawing format on Sheet 2. Sheet 1 with the front view of Model 1 lies behind Sheet 2 and is not visible.

**Note:** The sheet camera is moved to Model 4 if Model 3 was not deleted in Step 10.

When Sheet 1 is made current, Sheet 1 moves forward and the sheet camera moves to Model 2 (drawing format) and displays the Front view of Model 1 within the drawing format, because Model 2 (drawing format) rests on Sheet 2.

12. Arrange the views on the sheet.

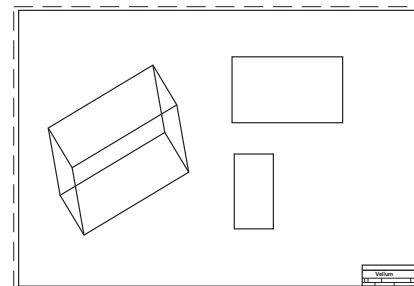



## Views

In the previous chapter, the concepts of sheet views and detail views were discussed.

These two different views are easy to identify on the screen:

- Each item displayed inside a view window is a detail view.
- The area outside (and underneath) all detail view windows is the sheet view.

This section goes into greater detail on views and models, including Sheet into View.

### More about Associative Detail Views

When creating a detail view with the **Detail View** tool on the tool palette or the *Sheet Into View* command in the Views menu, the same model is viewed through a second camera—the *detail view camera*.

The detail view camera behaves like the sheet camera except it displays its view of the model in a *view window* on the sheet.

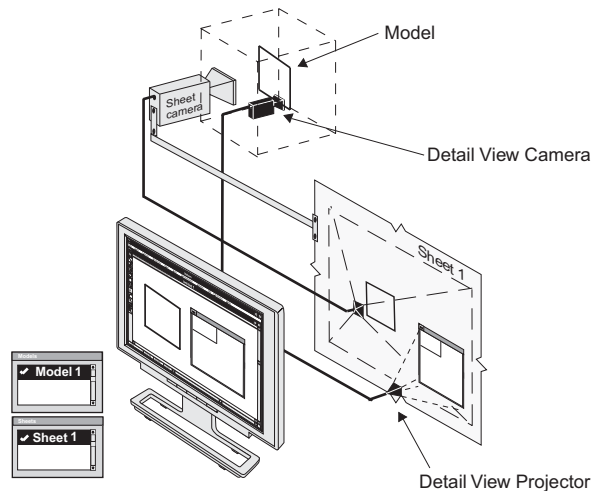

**Model** with one additional detail view camera projecting its view in its active **view window**.

#### *Tech Note:*

Regardless of the method used to create a View Window, they all behave the same way. They all have a border which can be turned on and off in the Views menu with the *Show/Hide View Boundaries* command. The active view is displayed in a view window which has a title bar.

#### Tip:

To move a view window to another sheet, cut the view window with the *Cut* command in the View Windows's control menu, make the other sheet active and place the view window with the *Paste* command in the Edit menu on the current sheet.

All views displaying the same model are associative. For example, when changing the geometry on the sheet, the geometry in the view window changes, and vice versa.

Having several views displaying the same model they have to be associative, because no matter which view is active—the sheet view or any detail view—the same model is being edited.

### Activating Views

To make a view active click on it. When clicking on the sheet, the sheet view becomes active. When clicking in a view window, the detail view becomes active.

### Identifying Models

When it is uncertain which view displays which model, open the Models dialog box. When clicking on the drawing area, the check mark moves to the model displayed on the sheet. Click in a view window and the check mark moves to the model displayed in the detail view.

### Scaling Views

Zooming affects the sheet view and the detail view differently. Zooming in a detail view with the SHIFT (Windows) or the CONTROL (Macintosh) key pressed, changes the view scale property of that view only. With the *Zoom* or *Stroke-Zoom* commands, it is possible to change only the screen display scale of the sheet and all detail views projected on that sheet, but not the size of the geometry itself.

### Text, Dimensions, Crosshatching, Fills and Detail Views

While it is important that changes made to geometry in one view be reflected in the other views, the same is not true for text, dimensions, crosshatching and fills. The views become very cluttered and are rendered useless if all notations made in one view appear in the others. For that reason, Ashlar-Vellum designed these elements so that they would not be associative, in line with standard drafting practice.

*Tip:*

This procedure is very useful to identify models and sheets for renaming.

*Tip:*

Change the scale of a detail view with the *Properties* command in the view window's Control menu.

## Sheet Into View Command

The *Sheet Into View* command places all the geometry on a sheet, including dimensions, text, crosshatching, and fills, into one view window (the front).

The view window created with the *Sheet Into View* command behaves like any view window created with the **Detail View** tool. Although both view windows behave the same, the *Sheet Into View* command includes three automatic steps which are not performed when a view window is created with the **Detail View** tool.

The *Sheet Into View* command:

- Creates an additional model (blank or containing a standard drawing format if selected).
- Moves the sheet camera to that model (blank or with the drawing format) to display it on the current sheet.
- Puts all geometry, including text, dimensions, crosshatching, and fills on the current sheet into a view window and displays it in the scale specified within the selected drawing format.

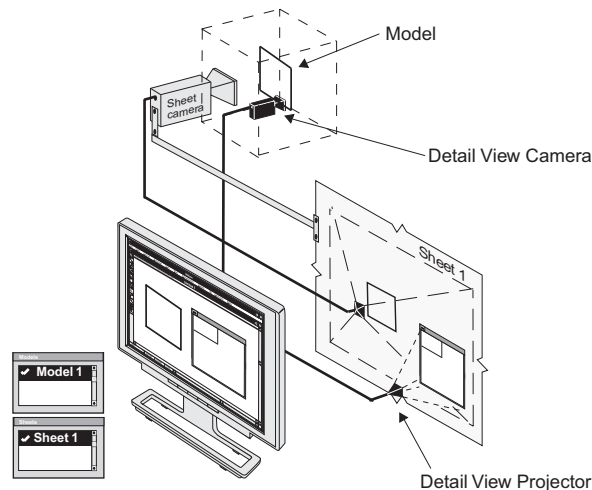

**Model** with one additional detail view camera projecting its view in its active **view window**.

### Tip:

Documents are more manageable if all existing view windows are deleted before using the *Sheet Into View* command.

### Tip:

Use the *Sheet Into View* command when importing a drawing format which is a different scale from the geometry.

### Placing Geometry into a View Using Sheet into View

1. Draw the geometry.
2. Choose **Views>Sheet Into View**.
3. Choose the layout from the Layout menu.

It is possible to choose from a view with no drawing format or a view in a standard drawing format.

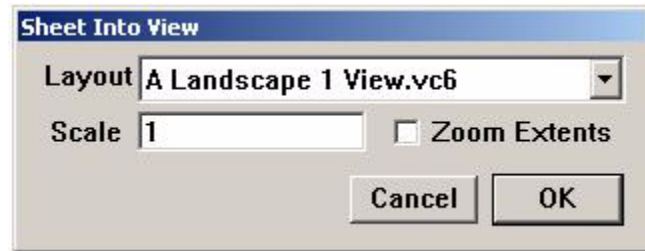

4. Enter the scaling value in the Scale box if you need a certain value, or just check the Zoom Extents option to make the drawing fit into the view window. Factors greater than one enlarge the model in the view(s) and factors less than one reduce the model.
5. Click OK.
6. Choose **Arrange>Zoom All**.

The geometry scales and the views appear as specified. By specifying a drawing format, it imports into the view and scales appropriately for the specified drawing size.

### Adding Formats to the Sheet Into View Dialog Box List

To create the drawing formats and add them to the list in the Sheet into View dialog box do the following:

1. Start a new document.
2. Select the **Detail View** tool and create a view window.
3. Display the Models dialog box and create a new model.
4. Click on the sheet and make Model 2 the current model in the Model dialog box.
5. Click in the view window and make Model 1 the current model in the Models dialog box.
6. Click on the sheet to activate Model 2.

*Tip:*

Add your own formats to this list as described in chapter 15 Graphite Documents, or modify the layouts provided to meet your needs.

7. Create the drawing format at a scale 1:1 or import one of Ashlar-Vellum formats and modify it.
8. Save the drawing with a proper name in the Layouts folder of Graphite. The Filename is listed on the Layout menu.

See chapter 15 Graphite Documents, for more information on formats and customizing.

### ***Erroneous Sheet into View***

Having mistakenly invoked the *Sheet Into View* command, use *Undo* to recover. If this is not done immediately, use the following method to manually back out.

#### **Recovering from an Erroneous Sheet Into View**

1. Delete all view windows on the current sheet by choosing Delete from the view window's Control menu of each view.
2. Make Model 1 in the Model dialog box the current model for the Sheet View.
3. Delete Model 2.

### **View Orientation**

There are many options for changing the view orientation within the view window.

- Rotate the view with the Trackball.
- Choose **3D>Views** and select a view.
- Select a view from the pull-down menu on the Trackball.
- Set a view with the *Define View* command.
- Unfold a view with the *Unfold View* command.
- Set the view to the current work plane with the *View the Plane* command.

#### *Tip:*

It is also possible to open one of the layouts in the Layouts folder of Graphite and change it. But be sure to save that layout under a different name before modifying it.

**Define View Command**

The *Define View* command in the Views menu defines an auxiliary view orientation or changes the standard view orientations. The standard views cannot be changed unless the locked check box is clicked off. The default configurations are defined as follows:

**Front**

The view of the x,z plane.

**Isometric**

The view of the axes rotates as shown.

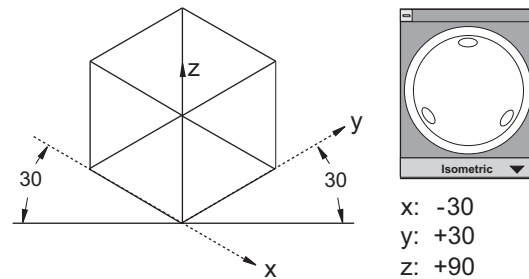
**Right**

The view of the y,z plane.

**Top**

The view of the x,y plane.

**Trimetric**

The view of the axes rotates as shown.

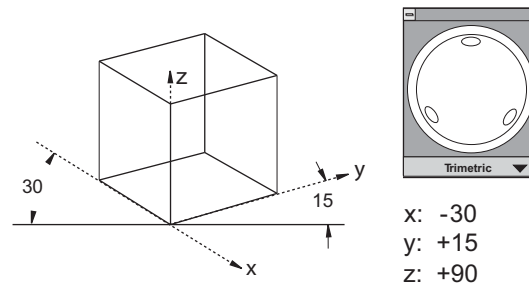

## Specifying a New View

Follow these directions to specify a new view orientation.

1. Choose **Views>Define View**.

The Define View dialog box displays.

2. Click New.

The new work view is named View 1.

The Redefine View dialog box displays the locations for the current view. If that view is the desired view, click OK.

Otherwise, proceed with the specification. The *Normal* (line of sight) specification highlights in the dialog box.

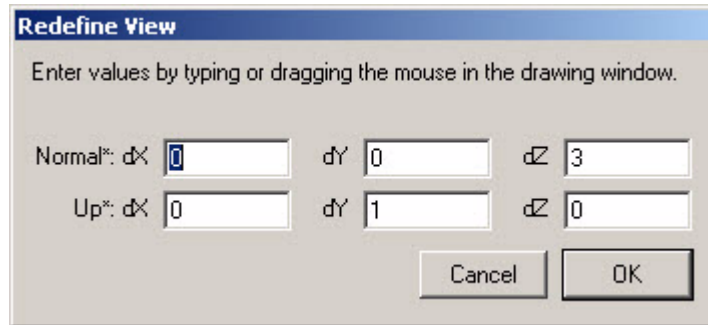
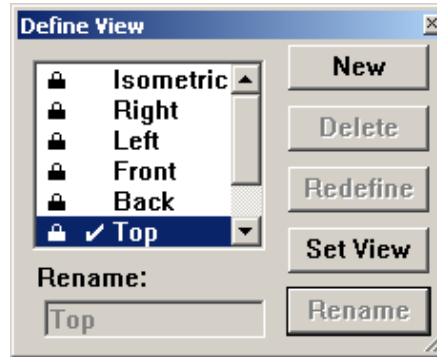

3. Drag a line in the active view window to indicate the Normal (line of sight) vector.  
The *Up* data field becomes selected.
4. Drag a line in the active view window indicating the **Up** direction.
5. Click OK.  
The dialog box closes and the new view is defined.
6. Click Set View.  
The active view displays the new orientation.
7. Rename this view to give it a more distinctive name.
8. Close the Define View dialog box if there is no other need to define additional work views.

Be aware that simply rotating the view does not alter the orientation of the work plane in 3D space.

### Deleting a View Orientation

Select the view orientation to be deleted from the View list and click the Delete button.

### Redefining a View Orientation

There are two methods to change the orientation of the axes of a view.

#### By Example

1. Manipulate the view orientation manually with the Trackball.
2. Choose **Views>Define View**.
3. Select the view to redefine.
4. Click Redefine.
5. Click OK.

The Redefine View dialog box closes.

6. Dismiss the Define View dialog box if there is no other need for it.

#### By Definition

1. Choose **Views>Define View**.
2. Select the view to redefine.
3. Click Redefine.

The Redefine View dialog box displays the settings as they appear on the screen with Normal (line of sight) selected.

4. In the active view window, drag the Normal (line of sight).

The *Up* data field becomes selected.

5. Drag the direction for up.

When dragging the normal vector with the mouse, know that the vector, from the beginning point, points directly at you, not away from you. So when this new view is made current, the normal vector points out of the screen, not into it.

6. Click OK.

The Redefine View dialog box closes.

7. Dismiss the Define View dialog box if it is not needed.



### Renaming a View Orientation

1. Click the view orientation to be renamed.
2. Type a new name.
3. Click Rename.

### Renaming a Standard View Orientation

1. Click the standard view name in the list box.
2. Click the Locked box to toggle it off.
3. Type a new name.
4. Click Rename.

### Unfold View Command

The *Unfold View* command in the Views menu creates a view orientation from the active view window by specifying a line from which to unfold the new view orientation.

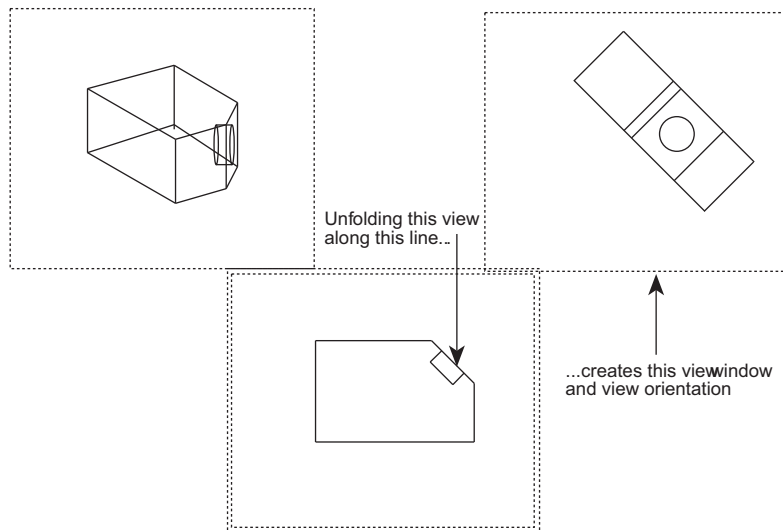

By specifying a line a 90°-plane along that line, which is coming towards you away from the screen. This plane is folded by 90° and creates the new view orientation from the active view.

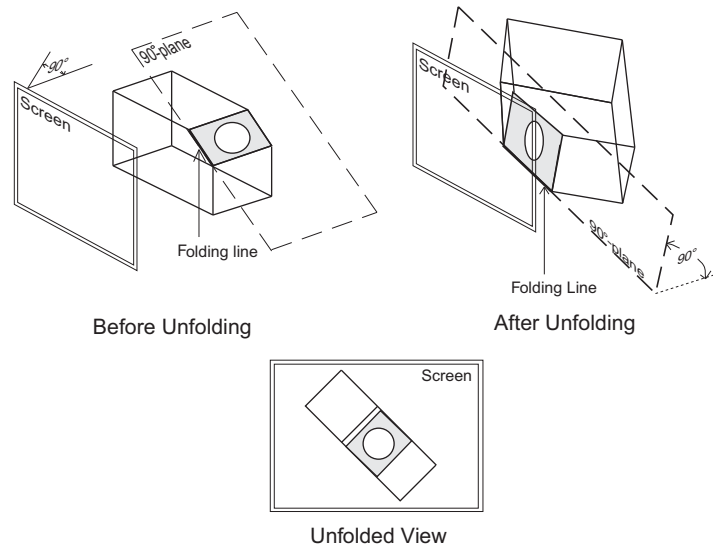

**Note:** Use this command only in a view orientation aligned parallel to an object face. When using it in a differently aligned view (where object face is not parallel to the screen) this command may work correctly, but the result is unpredictable in most cases.

### Unfolding a View

1. Choose **Views>Unfold View**.
2. Click the endpoints of the line on which to unfold.  
An actual line is not necessary, just indicate a vector.

The active view window shows the view unfolded 90° from the line specified.

### Setting the Screen to the Work Plane

Change the point of view to look directly at the work plane. Choose **Views>View the Plane** to do this.

### ***View the Plane Command***

This command in the Views menu rotates the view orientation in the active view window to match the work plane. The view changes so the work plane becomes horizontal on the screen. The **y**-direction of the work plane becomes vertical, and the **z**-direction of the work plane becomes the line of sight, coming directly out of the screen.

To leave this view orientation, select a view from the Trackball pull-down menu or the Views submenu, or use the Trackball for free rotation.

### **Editing a View Without Editing the Model**

The geometry within view windows is associative. Making a change in one window, the change affects the model and therefore the geometry in all views. In the drafting phase of the design process, it is possible to edit the geometry in one view window without making the same changes to the model. For example, it might be necessary to clarify the view by removing a line or adding an arc visually, but not unnecessary make the actual change in the model.

Accomplished this by using the *Flatten View* command on the Views menu. When flattening a view, the geometry is taken out of the view and placed back on the sheet, where it is no longer associated with the model. In this way, it is possible to make changes to the geometry without changing the model or other views.

A typical situation for flattening a view is when a view should display fillets but the fillets do not need to be displayed in the model.

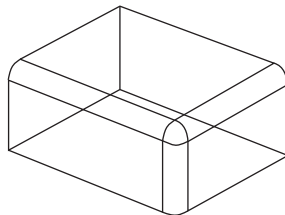

Trimming such intersecting fillets in 3D is a difficult problem that was addressed in the *Getting Started Guide*, but Graphite makes this problem very easy to solve.

### ***Flatten View Command***

The *Flatten View* command in the Views menu places a projection of the visible geometry in the active view window onto the sheet at full scale. When the view is flattened, all overlapping lines of equal length and all lines parallel to the line of sight are removed. The geometry is no longer associated with the model. If changes are made to the flattened geometry, those changes do not affect the model. If changes are made to the model, the flattened geometry is not changed.

1. Select a view window to make it the active view.
2. Choose ***Views>Flatten View***.

A dialog box displays a warning message. Since flattening disassociates the current view from the model, be certain that this is not only the correct view to flatten, but also that it really should be flattened. All dimensions in the view are deleted because the 3D dimensions are not correct in 2D geometry.

3. Click OK. The geometry is placed on the sheet at full scale.

#### **Important:**

- The geometry is flattened at the scale being viewed. This scale is listed in the Control menu of the detail view.
- Text and crosshatching are treated like geometry by this command.
- Dimensions no longer update if a change is made to the 3D model since the flattened geometry is disassociated, but they change if the flattened geometry is altered. Also if the geometry is dimensioned after it is flattened, the desired values must be entered manually because Graphite simply reads the length of the projected flat lines. To keep the dimensions, copy the view and flatten the copy, or group the geometry with the dimensions, then flatten the view.
- If the following message appears, *The current view and the draft view have the same model*, it is necessary to change the model on the sheet. Click the sheet, outside all views, then choose ***Views>Models***. Click New and then click Current. Repeat the above steps to flatten the view.

## View Layouts

Included with Graphite are layouts set up with various views that can be chosen using the *Sheet Into View* command in the Views menu. It is also possible to create your own view layouts. In all but the *Design.vc6*, each view has the same scale. In the *Design.vc6* layout, the Trimetric view is scaled as specified in the Sheet Into View dialog box and the other three views are scaled to 25% of the Trimetric view.

The default layouts available from the *Sheet Into View* command are as follows:

### **View Top**

This layout shows the Top view of geometry, just as it is seen in 2D.

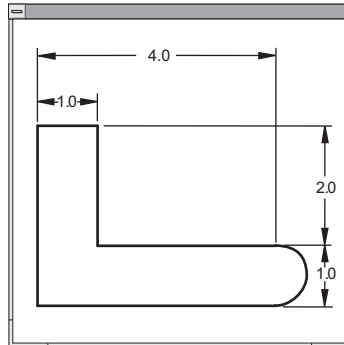

**Views with Standard Drawing Formats**

*A Landscape 4 VIEW.vc6* (Windows & Macintosh); =  
4 views for an A size sheet

*B Landscape 4 VIEW.vc6* (Windows & Macintosh); =  
4 views for a B size sheet

*C Landscape 4 VIEW.vc6* (Windows & Macintosh); =  
4 views for a C size sheet

*D Landscape 4 VIEW.vc6* (Windows & Macintosh); =  
4 views for a D size sheet

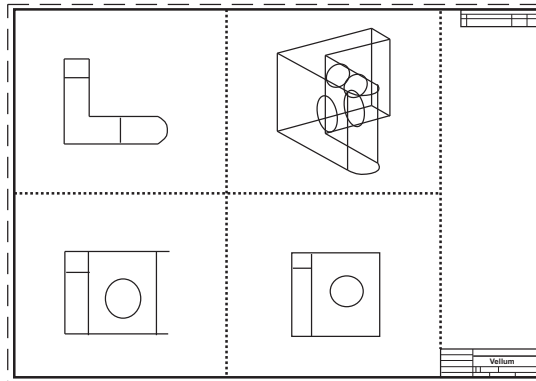

### ***Design.vc6 (Windows); Views Design 4 (Macintosh)***

This layout creates a Trimetric view at full scale and Top, Front, and Right views at 1/4 scale.

The design layout is primarily for viewing the model while designing it. When choosing this layout it may be desirable to change the scale and rearrange the smaller views to prepare for plotting.

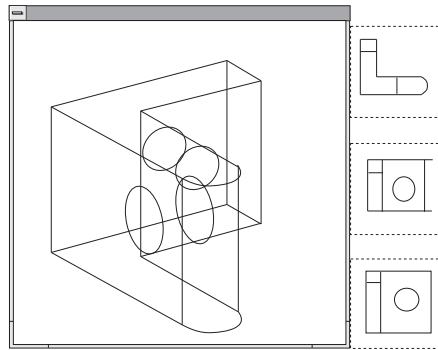

### ***Draft.vc6 (Windows); Views Draft 4 (Macintosh)***

This layout creates four full-scale views: Top, Front, Right, and Trimetric.

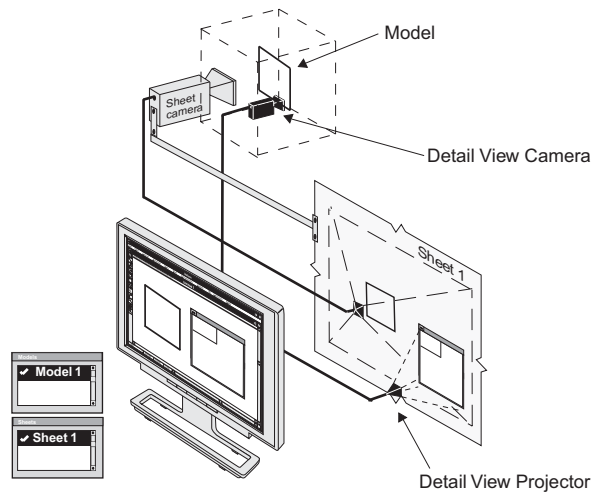

**Model** with one additional detail view camera projecting its view in its active **view window**.

***Trimtric.vc6 (Windows); View  
Trimetric (Macintosh)***

This layout is a single Trimetric view at full scale.

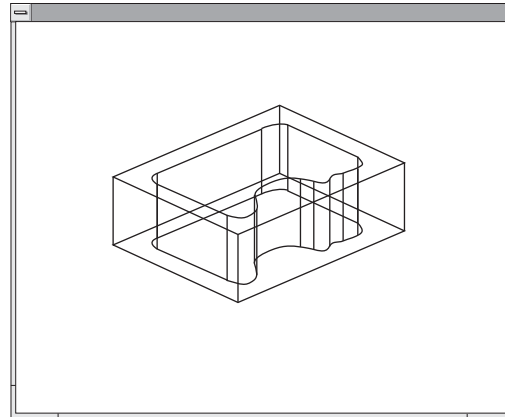
***Frntrt.vc6 (Windows); Views  
Front and Right (Macintosh)***

This layout displays two full-scale views, the Front and Right.

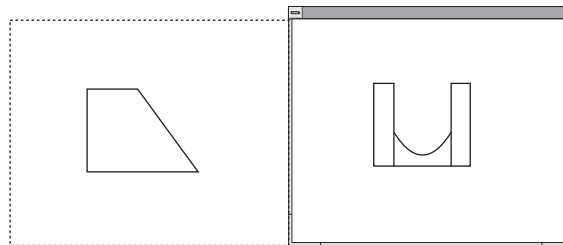
***Frnttop.vc6 (Windows); Views Top and  
Front (Macintosh)***

This layout displays two full-scale views, the Top and Front.

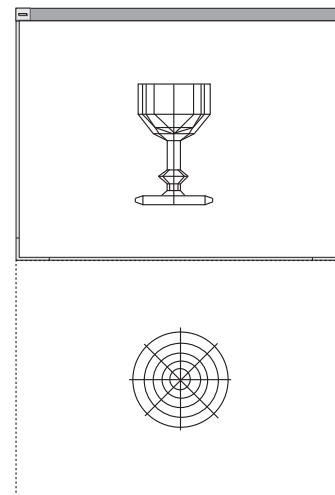



## Creating Custom View Layouts

The specifications for the view layouts available from the Sheet Into View dialog box are in individual Graphite drawing files stored in the Layouts folder in the Graphite folder. To create your own layout or a customized drawing format, simply edit one of the existing drawings in the Layouts folder, or create a new drawing and save it in the Layouts folder. The filename will then appear in the pull-down menu in the Sheet Into View dialog box.

### Method 1

1. Choose **File>Open** and open a Layout file in the Layout folder.
2. Save the file under a different name in the Layout folder by choosing **File>Save As** before doing any changes.
3. Customize the layout as needed.
4. Save the file.
5. Select **Views>Sheet Into View**.
6. The new layout appears in the pull-down menu in the Sheet Into View dialog box.

### Method 2

Another way to create own layout is to design it in a new document.

1. Open a new document by choosing **File>New**.
2. Create a view window with the Detail View function.
3. Make the current sheet active by clicking anywhere outside the view window on the sheet.
4. Choose **Views>Model** and create Model 2.
5. Make Model 2 the current model in the Models dialog box.
6. Duplicate the view window as often as needed.  
Duplicating or copying a view was discussed in Chapter 13.
7. Set each view window to the desired view orientation with the on-screen Trackball pull-down menu or the Views submenu in the Views menu.
8. Select *Properties* in the detail view window's control menu to scale each view window.
9. Save the new layout under a proper name in the Layout folder of the Graphite folder.

#### *Tip:*

Look at one of the files in the Layouts folder to see how it is set up. Be sure not to make any unwanted changes to these layout files.

## Drafting Methods with Views and View Layouts

Two different methods exist for creating 3D wireframe models:

- Start the model creation on the drawing sheet and add views later for editing and viewing the model from different angles.
- Use a view layout from the beginning and create the model in different view windows simultaneously.

### Method 1

Open a document and create the geometry on an empty sheet. With the on-screen Trackball and the view commands in the View submenu, rotate the model and edit it from different angles as long as any detail view windows have not been created.

To view the geometry from different angles simultaneously, create detail view windows with the **Detail View** tool and place them on the sheet. The sheet view then shows an image of the model in the Top view on the sheet. In the view windows, display different view orientations of the geometry, like front, top, trimetric, etc.

As soon as a view window is created, the sheet view of the geometry remains fixed in the Top view parallel aligned and rigidly fixed to the sheet. As a result the view angle can only be changed in the detail view windows.

The view orientation of a sheet with a detail view cannot be rotated with the Trackball.

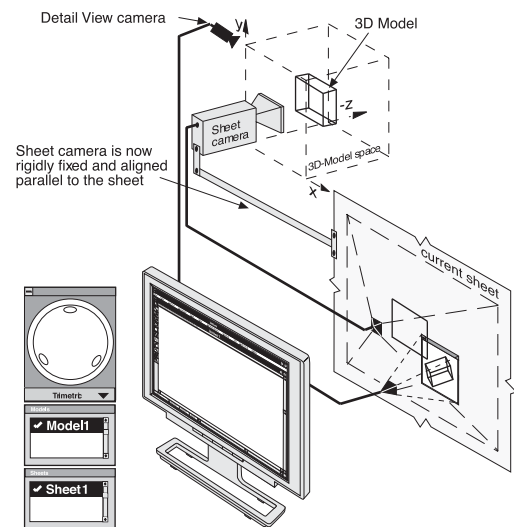

One model with one additional active **Trimetric** view window

The sheet view of the geometry may overlap the view windows on the sheet as shown in the upper graphic. Create a new sheet with the Sheets dialog box in the View menu and *Cut* and *Paste* the view window from Sheet 1 onto Sheet 2 to get a clear view on the view windows.

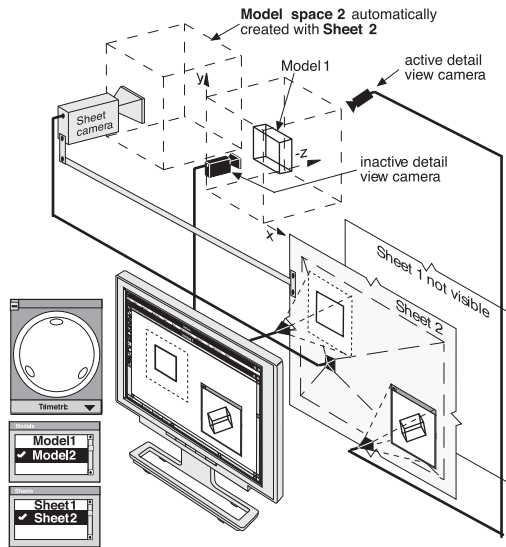

**Right and Trimetric** view window on **Sheet 2**  
**Model space 2** is empty, **Sheet 1** is not visible.

Something similar, but more elegant, is done by the *Sheet Into View* command in the Views menu. *Sheet Into View* puts Model 1 into one or more views and puts Model 2 on the current sheet.

### Method 2

With this method choose a view layout with the *Sheet Into View* command. The views provide a vantage point of the model. It places all geometry into one of the view layouts. It is possible to customize the view layouts.

*Sheet into View* puts Model 1 into one or more views as specified by the choice from the dialog box and creates Model 2 and projects it onto the current sheet.

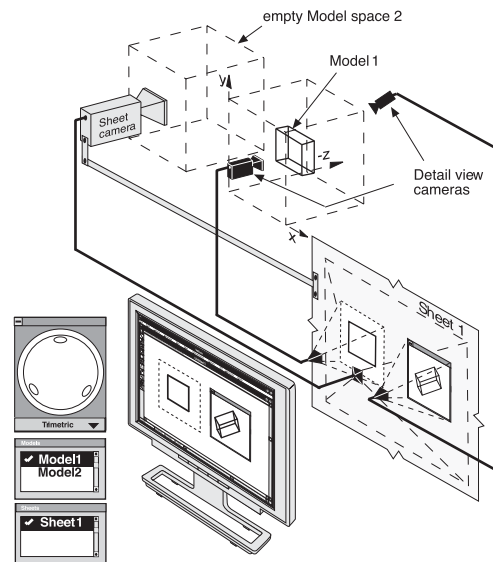

Layout with views **Front** and **Trimetric** loaded with **Sheet Into View**....

- By choosing one of the layouts that contain a title block and a border format, that format becomes Model 2 and is projected by the Sheet camera in the Top view on the current sheet.

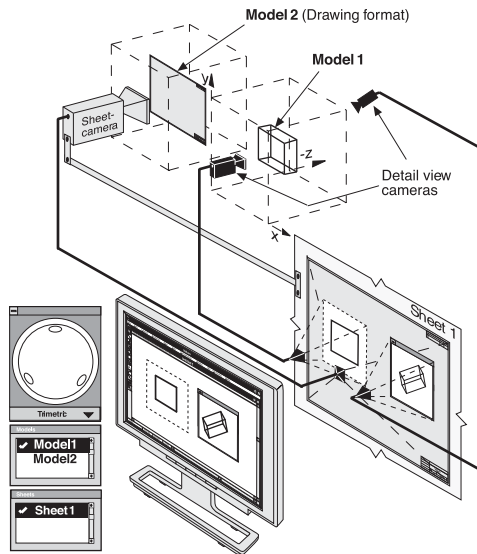

Layout with views **Front** and **Trimetric** including drawing format loaded with **Sheet Into View...**

## ***Combining Sheets, Views and Models***

In general, a powerful CAD program is necessary for two tasks:

- The creation of the designs.
- The generation of 2D engineering drawings, or blueprints, in order to get the designs built.

The design phase is effortless and very productive with the help of Graphite's Drafting Assistant, integrated parametrics (Chapter 16), and the intuitive user interface itself.

For the second of these two tasks, very powerful and flexible drafting functions are desired, since there are so many possible types of drawings that might need to be created. One of the specific features in Graphite that handles this so well is the combined power of sheets, views and models.

For most daily work, it is not necessary to know anything about the relationship between sheets, views and models. But for some tasks it is helpful to understand this relationship since it offers elegant solutions that were not possible without the combined power of the features in Graphite.

The relationship between sheets, views and models makes it easy to:

- Place part views in different scales, such as 1:50, in a standard drawing format with a title block and borders that must be plotted at a scale of 1:1.
- Create detail views of an object that are not associative to the original model.
- Create customized drafting layouts.
- Recover from an erroneous *Sheet into View* command.

The first section of this chapter explained the use of sheets, views and models. Each is a simple and straight forward operation. In the graphics are shown the environment, and how sheets, views, and models are set up in Graphite. It is necessary to know the exact definition of all engaged components and the rules that describe how they interact.

## Components

The environment in Graphite for handling all geometry created can be described by five components—sheets, models, views, cameras, and projectors.

First, all geometry created is not created directly on the sheet on the computer screen but somewhere outside of the sheet in an infinitely large three-dimensional work space (Model space). All geometry is placed here as separate models. Only images or views of these models display on the sheet.

## Sheets

A sheet is an infinite 2D planar area that displays an image of one or more models. The image of a model is picked up either by the Sheet camera and projected onto the sheet (the Sheet View) or by a Detail View camera and projected into a view window which is resting on the sheet (the Detail View).

- Sheets are arranged behind each other so only one at a time can be seen.
- Create as many sheets as desired, but with each sheet a blank model is automatically created, similar to the drafting board when starting with a clean sheet.
- Independent of how many models exist, it is possible to delete all sheets but one—the current sheet—since Graphite needs at least one sheet to display the models even if they are blank.
- When deleting a sheet, all Detail Views resting on that sheet are deleted.
- Display as many Detail Views on one sheet as needed but only one sheet (Sheet View) at a time.
- When changing the current sheet, the related model is always activated. Change this relation only by assigning another model to that sheet.

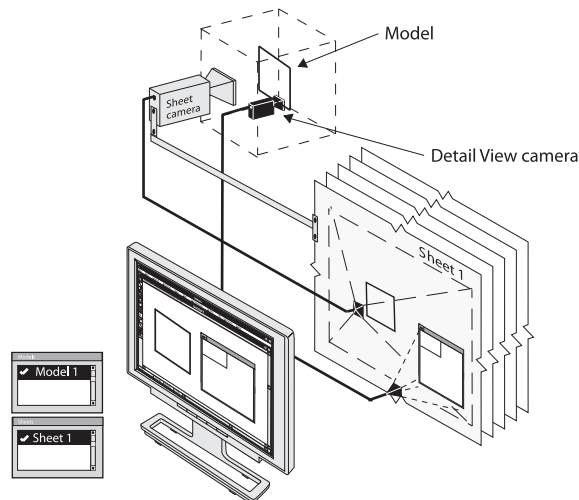

## Models

A model is a collection of geometry, dimensions, text, fills and hatching. Models are placed in an infinite three-dimensional area. A model can be blank (then we call it Model space) just as it is when launching Graphite and looking at a blank sheet. Images of models are picked up by either the Sheet camera or by Detail View cameras and projected on the sheet. The view of the Sheet camera is called a Sheet View and the views of the detail cameras are called Detail Views.

- Create and delete as many models as desired.
- When changing the current model, move the related camera. The camera you move depends on what is active—the sheet or the detail view. If the sheet is active, the Sheet camera moves to the current model. If the detail view is active then the related Detail view camera moves.

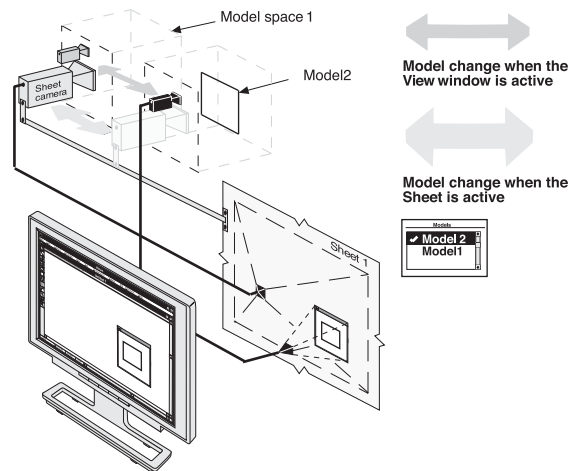



## Views

Views are the images picked up by cameras and projected on sheets. Graphite has two types of views—the Detail View and the Sheet View.

### ***Detail Views***

- Detail Views are picked up by Detail View cameras and always displayed in a view window which rests on the sheet. They have boundaries and display only a limited view of the model.

Create as many views as necessary and move or copy and paste them to different sheets.

When deleting a detail view, the Detail View Camera deletes. When deleting a sheet which contains a detail view, the detail view deletes also since the detail view rests on the sheet.

- Place views from different models on one sheet, but each view can display only one model at a time.
- Once a detail view is created, the sheet camera remains stationary in the original x,y (world) orientation. The view of the sheet can not be changed.

### ***Sheet View***

- There is only one sheet view for each sheet. The sheet view is an infinite view picked up by the Sheet camera and displays everything on the sheet outside of all view windows.

The sheet view cannot be deleted and needs at least one sheet to display its view.

Since the sheet view, like the detail view, can display only one model at a time, use detail views to show more than one model on a sheet.

- To activate a detail view click in the view window; to activate the sheet view click on the sheet outside of all detail views. If the Models dialog box is displayed, the related model is highlighted.
- The view orientation of a sheet becomes fixed when a detail view is created. The sheet camera remains stationary in the original x,y (world) orientation. The view of the sheet cannot be changed.

#### *Tech Note:*

The *Drawing Size* command changes only the plot scale but not the scale factor of the Sheet view. Even if the view is scaled to fit the paper format the scale factor remains 1:1 since the real size of the geometry is not affected.

*Tech Note:*

When changing the sheet, the Sheet camera is moved to the selected sheet and automatically displays it at the view scale which was current when the sheet was last changed.

### **Cameras and Projectors**

There are two type of cameras—one Sheet camera and as many Detail View cameras as detail views created.

- The Sheet camera is permanently installed as default and displays its view via the sheet projector on the sheet.

To move the Sheet camera perform a model change either by the *Models* command or by the *Sheets* command in which the Sheet camera moves automatically to the related model.

- Detail View cameras display their views via Detail View projectors in view windows which rest on the sheet.

Install as many Detail cameras as desired even if each one is looking at one model. Install Detail cameras by creating Detail views either by the **Detail View** tool from the tool palette or with the *Sheet Into View* command.

Move Detail View cameras to another model by performing a model change when the view window is active.

- Both cameras, the Sheet camera and a Detail View camera, can look at only one model at a time.

### **Using Sheets, Views and Models**

We listed many rules in the sections above and they all describe the same fact that Graphite administers geometry (models), views and sheets separately. That has a lot of advantages. The most impressive example is if you delete a sheet displaying geometry. The geometry is not lost since the related model is not deleted.

Practice the following examples and implement them in daily work. Using Models, Sheets and Views will become second nature and you will never want to work without them.

### Recovering from Deleting a Sheet Displaying Geometry

To restore the geometry displayed on a sheet deleted unintentionally, proceed as follows:

1. Select **Views>Sheets**.
2. Click New to create a new sheet.
3. Click Current to activate the new sheet and draw some geometry.
4. Make another sheet active by highlighting a different sheet in the Sheets dialog box and click Current.
5. Close the Sheets dialog box and select **Views>Models**.
6. Search for the before-displayed geometry by activating each Model followed by a *Zoom All* command until the previous geometry displays on the new sheet.

### Displaying Three Components on One Sheet

Sheets, Views and Models are very helpful to display several components of a part created by different drafters on one sheet. The following simple example shows how to perform this task:

1. Open a new document.
2. Draw an ellipse.
3. Save the drawing as *ellipse.vc6*.
4. Open a new document and draw a rectangle.
5. Select **Views>Sheet Into View**.

6. In that dialog box, choose the ViewTop layout, set the Scale to 1 and click OK.

Now one **Sheet** is with one view window showing the Rectangle (Model 1). The Sheet camera aligns to Model 2 (created with the *Sheet Into View* command) displaying a blank model space on the sheet.

7. Make the sheet active by clicking on it and draw a circle.
8. Select *Sheet Into View* (the sheet still active) and choose Top view again with the Scale factor 1.

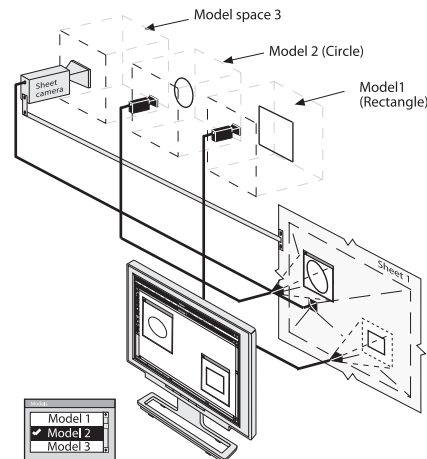
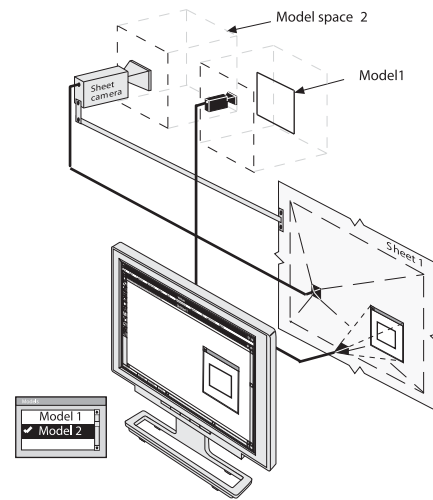

Now one Sheet has two view windows, one displaying the rectangle (Model 1) and one displaying the circle which became Model 2. The Sheet camera moves to the new Model 3 and an empty model space is displayed on the sheet.

9. Activate the sheet by clicking on it and select **File>Import**.
10. Select the file *ellipse.vc6* and click OK.

The ellipse imports onto the current sheet and is added to Model 3 which was active when the *Import* command was performed.

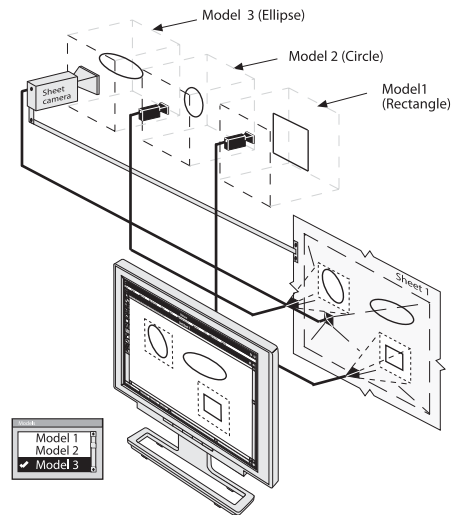

11. Arrange the two view windows around the ellipse and rearrange the rectangle and the circle with the *Zoom* commands in the *Arrange* menu like in the following graphic.

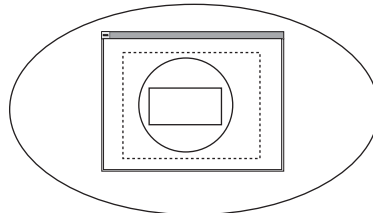

12. Activate the sheet and in the *Views* menu deactivate the *Show View Boundaries* command.

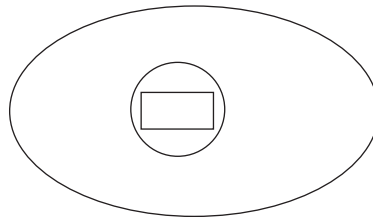

*Tech Note:*

In order to select overlapping view windows, *Auto Front* must be deactivated, as described in Chapter 13, "Viewing Geometry."



# Graphite Documents

A document is a Graphite file. Whenever opening Graphite or choosing New from the File menu, a new document appears in the Graphite window.

The sheets and layers features add a great deal of flexibility to the documents. They show various parts of a document individually or as part of the whole. Each document has one or more sheets, like the sheets of paper in a set of blueprints, and each sheet is made up of layers which are hidden or displayed as needed.

New users are sometimes too busy learning about Graphite to think about how to organize the drawings. Consider organization early, however, since eventually there will be a large number of drawings. Organization is particularly important for sharing files with other people.

The following topics are covered in this chapter.

- Using Documents, including Opening, Recent File List and Saving
- Importing/Exporting
- Drawing at Full Scale
- Drawing Scale and Paper Size
- Drawing Formats
- Forms
- Printing and Plotting

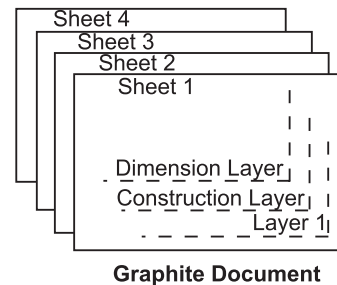

## Using Documents

A drawing can be a simple part or a complex assembly. A new document opens as *Untitled* and remains untitled until it is saved. Saving a drawing is explained later in this chapter.

The commands used to manipulate documents are in the File menu and in the **Window>General** palette.

### New

CTRL+N (Windows); ⌘+N (Macintosh)

This command in the File menu, or in the **Window>General** palette, creates a new Graphite document.

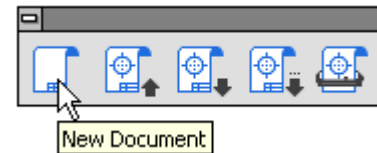

The new document has no name (the title bar shows Untitled 1), and is set with the default options, such as pen style or grid display.

Opening more than one new document, the subsequent documents are numbered sequentially until named upon saving.

### Opening Files

Open files using the *Open* command in the File menu or in the **Window>General** palette in the program or by double-clicking on the file to launch the program and the file.

#### Open Command

CTRL+O (Windows); ⌘+O (Macintosh)

The *Open* command in the File menu, or in the **Window>General** palette, opens an existing Graphite document. The document appears in the drawing area maintaining the same settings as the last time it was saved.

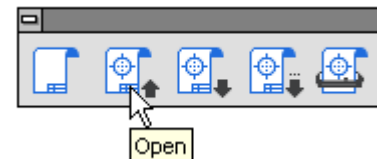

#### Tech Note:

Use the *Import* command to bring in drawings of other format types, such as *DXF*, *IGES*, or *ASCII* text.

The dialog box specifies the document name and folder as necessary.



## Opening a Document

1. Choose **File>Open** or click the Open (second) icon in the **Window>General** palette.

The dialog box appears.

The current folder displays the files and/or folders contained within.



2. Display the appropriate folder containing the document to open.

The Vellum Graphite file extension is .vc6, where v is for Vellum and c6 is the chemical abbreviation for Graphite.

3. Click the file name to open in the list box.
4. Click OK.

## Opening a File when Graphite is not Running

Open a file and launch Graphite at the same time by double-clicking on the file. The program launches automatically and the file opens. By using this technique, no untitled file opens.

## Recent File List

Another way to access files that were opened recently is through the *Recent File List* that appears at the end of the File menu. This list contains the names and paths of recently opened Graphite files.

To open a file from the *Recent File List*, simply select the file from the File menu. If the file has been moved since it was last used and the path is no longer accurate, Graphite provides the standard Open dialog box to locate the file.

## Saving a Drawing

Save a drawing by choosing **File>Save**, or **Save As**, or clicking the corresponding icons in the **Window>General** palette. The file is stored on the computer in the folder specified.

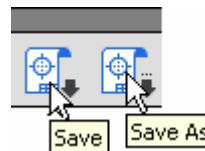

### *Tech Note:*

The number of files contained in this list can be set in the *Graphite.ini* file (Windows) or the recent list file in the User's Scripts folder (Macintosh). For more information, consult Chapter 5 "Basic Environment Settings."

*Tip:*

Use AutoSave so that Graphite automatically saves the work. Choose **Layout>Preferences>AutoSave**.

### Save Command

CTRL+S (Windows); ⌘+S (Macintosh)

The Save command in the File menu, or icon in the **Window>General** palette, saves the current Graphite document to its original folder. To save it to a different folder or with a different name, choose Save As. If the document has not been saved previously, the Save As tool dialog box appears automatically, requesting the name and the folder in which to save it.

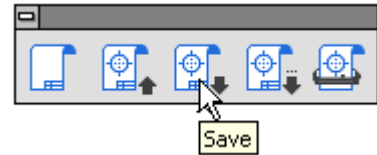

If the document was named and saved before, a brief message appears when choosing Save, and the program pauses while it updates the information.

Save frequently. Even though the drawing appears on the screen, it is not stored on the disk until saved. Hours of work can be lost because of a power failure. It is also important to save before performing any intricate, multistep maneuver. In that way, if the result is not exactly what it is hoped, abandon the file by closing it without saving.

### Save As Command

The Save as command in the File menu, or in the **Window>General** palette, saves the current document. A dialog box appears in order to name the current document, give it a different name, or save it to a different directory.

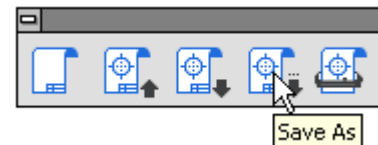

### Saving in the Current Directory

1. Choose **File>Save As** or click the Save As (forth) icon in the **Window>General** palette.

The Save Drawing As dialog box appears.

2. If necessary, display a different folder.
3. Type the name to use in the File name data field.
4. Either press ENTER (Windows), RETURN (Macintosh) or click OK.

The Vellum Graphite file extension is .vc6, where v is for Vellum and c6 is the chemical abbreviation for Graphite.

Use the Save As command to make a backup of a document.

## Making a Backup

It is always a good idea to make a backup of the file in case you want to return to the original version after making many changes. Choose **File>Save As** and save the file with another name. It's possible that periodic backups are made of the directories by you or your IT department, and you can go back to a previous version that way.

## AutoSave Command

This command is found under **Layout>Preferences** and directs Graphite to save a backup copy of the work periodically. If the computer crashes for any reason, the work done up to the last AutoSave is recoverable.

In the AutoSave dialog box turns AutoSave On or Off, and specifies the time interval (in minutes) between AutoSaves. At the specified interval, Graphite creates an AutoSave file with the base of the original file name and the .SAV extension. AutoSave prompts for a file name before creating an AutoSave file of untitled documents (created by using the *New* command from the File menu). If a file name is supplied, this file name is associated with the document and the AutoSave file. If Cancel is clicked, AutoSave skips that document, but the prompt appears again at the next AutoSave interval.

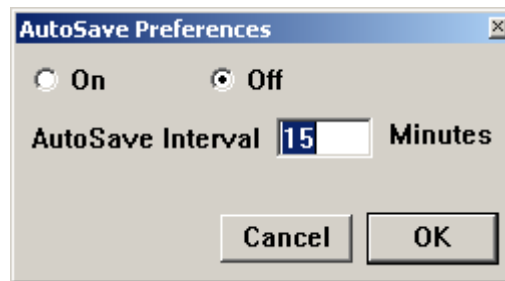

### Setting up AutoSave

1. Choose **Layout>Preferences>AutoSave**. The AutoSave dialog appears.
2. Switch AutoSave On or Off. The default setting is off.
3. Specify the time interval for AutoSaving in minutes in the AutoSave Interval data field. The interval can be from 1 to 60 minutes; the default setting is 15 minutes. An interval of 0 or less is equivalent to turning AutoSave off.
4. Click OK.

If *AutoSave* is on the work is automatically saved for the specified time interval. To save these settings permanently, choose **Layout>Preferences>Save Preferences**. Close any open untitled files before saving the preferences, otherwise, with AutoSave On, the *Save As* command continually appears.

### Close Command

CTRL+F4 (Windows); ⌘+W (Macintosh)

The *Close* command in the File menu closes the current Graphite document (the one displayed in the top window). If other Graphite documents are open, they remain open when closing the current document. If any changes were prompts for each made since the last time the current document was saved, a dialog box displays in order to save the changes. Close the document with or without saving the changes.

For Windows, close the document by double clicking the Control menu at the upper left corner of the title bar. For Macintosh, click the Close button once at the upper left corner.

### Exit Command (Windows) or Quit Command (Macintosh)

CTRL+Q (Windows); ⌘+Q (Macintosh)

The *Exit* or *Quit* commands in the File menu closes Graphite. If changes were made since the file was last saved, a dialog box displays in order to save the changes. If more than one document is open, an alert message displays in order to save unsaved documents.

## File Organization

Graphite automatically organizes files using the Directory function in *Preferences*. When opening, saving, importing and exporting files, Graphite goes to the directory or folder specified.

1. Choose **Layout>Preferences>Directory**.

The Directory Selection dialog box appears with four fields for specifying the directory location.

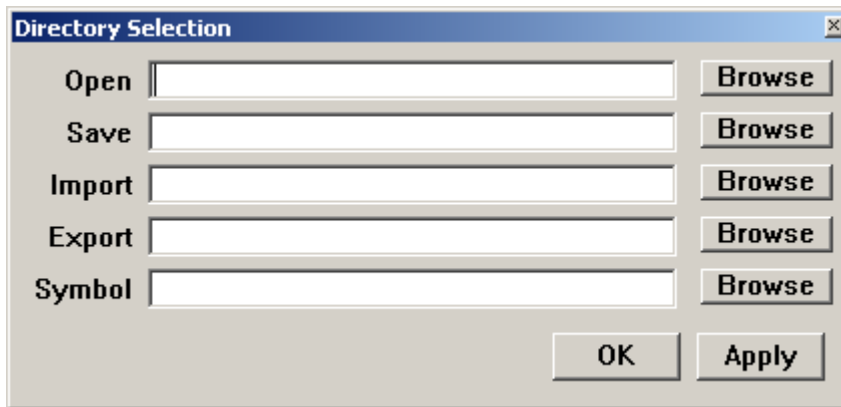

2. Enter the directory path in each data field. Either type the path or browse the computer for the folder and have the path entered automatically.  
To browse, click on the Browse button and locate the desired folder.

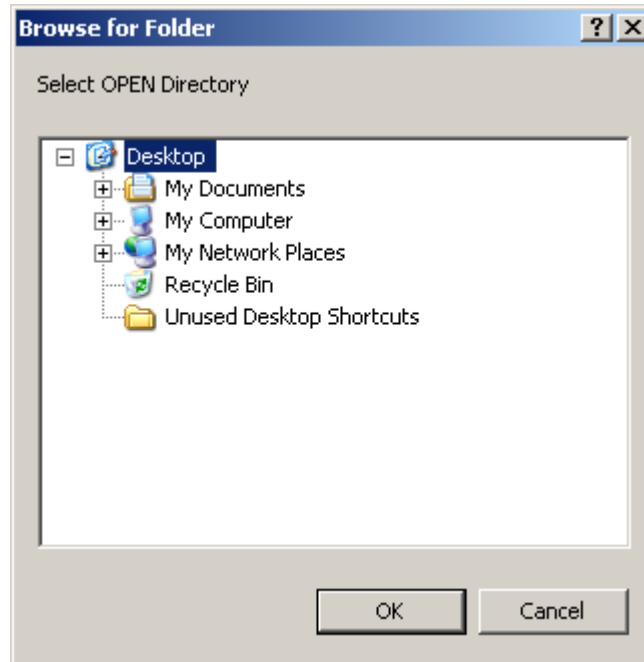

Click OK.

The path appears in the selected data field of the Directory Selection dialog box.

3. Repeat step #2 for all of the directories specified.
4. Click Apply to save the settings and close the dialog box.

## ***Importing and Exporting***

Before beginning a file translation for Graphite, establish a clear purpose for any particular translation. Consider if the translated data must be edited or just viewed and/or printed. If it is to be viewed or printed, use the Graphite Share™ utility available FREE on the Ashlar-Vellum web site. Graphite Share opens, views, prints and exports Graphite and older Vellum 2D/3D files. Send Graphite Share to a client or manufacturer free of charge along with a Graphite file. Share allows them to export the file themselves, experimenting with the file format that works best for their needs.

On the other hand, if the translated data must be manipulated and saved, consider if the target application that can handle the data being translated to it properly, such as multiple sheets in one file.

Remember that re-importing a file successfully into the original format neither proves nor disproves its translation accuracy.

Older versions of Vellum had difficulties with metric-to-English conversions. These were addressed in Graphite v6, but be aware of the issues if any archive files need to be converted.

Use Zip or Stuff-It to compress files before emailing. Using an email program's built-in compression has unreliable results on graphics, often converting them to text files. This is especially true if emailing a file from a Mac to a Windows-based system.

The reasons to use the import and export features of Graphite are:

- Bringing a document in from another application to work on in Graphite.
- Saving a document in a format other than Graphite for use with another application.
- Importing or exporting text to or from a Graphite document that's an ASCII text file.

Graphite offers a wide variety of options to accomplish this.

## Import Command

*Tip:*  
When importing into Graphite, choose **Arrange>Zoom All** to see the imported geometry.

This command in the File menu imports a document and places it in the current model. The names of documents in a format Graphite can read are displayed in a dialog box that works like the Open dialog box.

1. Choose **File>Import**.

A dialog box appears similar to the Open dialog box.

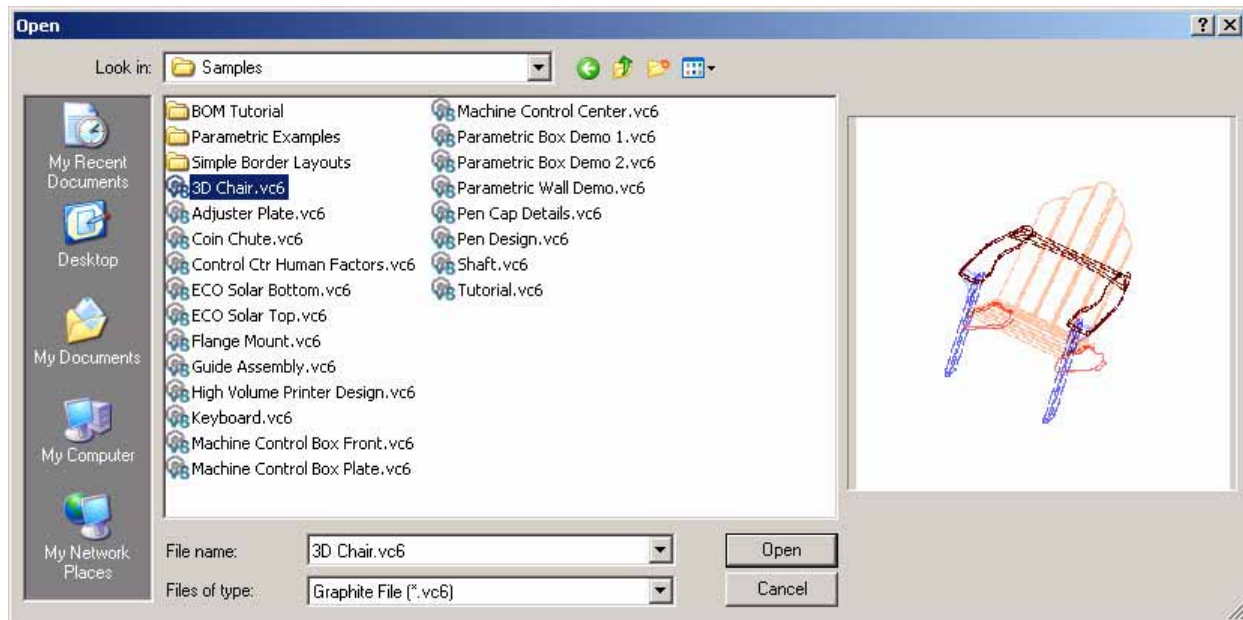

2. **Windows** Select the file type to import from the *Files of Type* list box. The list box shows all files of the selected type available in that folder.  
**Macintosh** Skip to the next step.
3. Double-click the File name to import.



The Import dialog box appears.

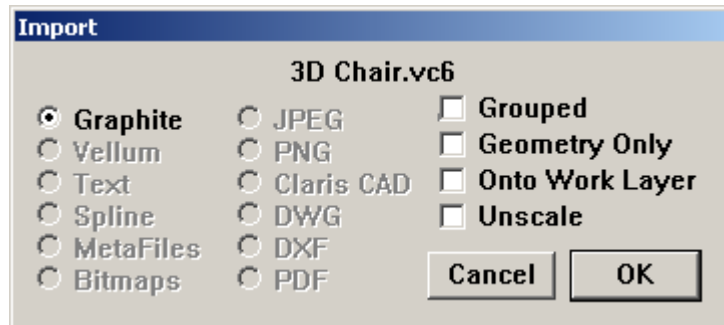

4. Specify import options.
5. Click OK.

The file appears in the drawing area. To save the file in its original format after editing, choose the **File>Export**.

The file formats Graphite imports are listed below:

<b>Graphite and Vellum</b>	Ashlar-Vellum's native file formats for current and previous versions.
<b>Text</b>	ASCII text file.
<b>Claris CAD</b>	Claris CAD native file format
<b>DXF</b>	AutoCAD's Data eXchange Format. R14 and ACAD2007 files can be imported.
<b>DWG</b>	AutoCAD's native file format. R14 and ACAD2007 files can be imported.
<b>IGES</b>	IGES version 4.0 Initial Graphics Exchange Specification. The translator also supports IGES entity 128 and 144 NURB surfaces and importing an unlimited number of entities.
<b>EPS</b>	Encapsulated PostScript format for printing to a postscript printer.
<b>Spline</b>	Text file, which Graphite converts to a spline.
<b>MetaFiles</b>	(Windows only) Windows Metafile Format

<b>Bitmaps</b>	(Windows only) Windows BitMaP Format
<b>Pict</b>	(Macintosh only) Macintosh native file format.
<b>BMI</b>	CADAM BMI's file format.

Using the *Import* command, Graphite detects the format of the document and displays a dialog box showing the format and asking how to bring the geometry into Graphite.

<i>Tip:</i> To ungroup the imported geometry choose <b>Arrange&gt; Ungroup</b> .	<b>Grouped</b>	Brings the geometry into Graphite grouped so it is a single unit in the Graphite document.
	<b>Geometry Only</b>	Brings in only the geometry, leaving any text, dimensions and crosshatching behind.
	<b>Onto Work Layer</b>	The imported geometry is placed on the work layer rather than on the layer on which it was originally created.
	<b>Unscaled</b>	When checked, uses the drawing scale to resize the part (i.e. a 12" line becomes six inches with a 2:1 drawing scale).

### ***Importing DXF Files***

While Graphite offers high visual fidelity for dimensions and text in DXF format, if the goal is to import or export archive drawings, preserving the text and dimensions, use a free copy of Ashlar-Vellum Share or buy Adobe Acrobat instead.

DXF files do not always specify units. Be sure to set Graphite to match the source file prior to importing it. Also, because individual users customize their systems, there is often difficulty in translating fonts, line weights and patterns, dimensioning styles, hatch patterns and custom symbols. Be sure these are also present on the destination system.

When importing a DXF file, the geometry is constructed according to the units set in Preferences when choosing the *Import* command. Be sure to set the appropriate units before importing DXF geometry.

### ***Importing ASCII Text from Another Document***

1. Choose ***File>Import***.

The Import dialog box appears.

2. Select the filename to import.
3. If *Text* is not selected, click the Text button.
4. Click OK.

The text appears in a text box in the drawing.

### ***Importing Splines***

Importing a text file that contains the coordinates of a spline, Graphite creates the spline according to the imported coordinates.

1. Select ***File>Import***.

Graphite displays the standard Open dialog box.

2. Select a text file that contains the coordinates for the spline.

The Import dialog box displays.

3. Specify the import option *Spline*.
4. Click OK.

Graphite begins creating the Spline.

### ***Creating a Text File for Importing a Spline***

1. Use a text editor, a word processor or a spreadsheet to create a text file.
2. Input X, Y and Z values for the spline coordinates.

The text file should be tab or space separated. Each line ends with a return. Line feeds after each return should have no effect.

The text file should conform to the following columnar format:

1	1	0
2	2	0

Specify decimal coordinates as well:

1.33	1.1	0
2.4	2.5	3.5678

Be sure to press ENTER (Windows) or RETURN (Macintosh) after the last coordinate, if Graphite will not import the coordinates specified in the last line.

3. Save the file as *Text only* and import into Graphite to create the spline.

### ***How Importing Affects Some Objects***

It is difficult to exchange data between different graphic programs because each program defines geometric objects differently. All entities created in one program may not translate accurately or at all depending on what the program supports. The following lists are specifics about entities for two translators.

#### **DXF/DWG**

##### **Blocks**

##### **Center Mark**

##### **Crosshatch**

##### **Donuts**

##### **Double lines**

##### **Points**

##### **Polygons**

##### **Polylines**

#### **Graphite**

Convert into groups.

Convert into lines.

Convert to grouped lines.

Convert to grouped Three Point arcs.

Convert to lines.

Convert into Points.

Convert into grouped lines.

Polylines and 3D polylines convert into lines.

---

<b>3D Face</b>	Converts into lines that define the polygonal boundary of the face.
<b>View Ports</b>	Not supported.
<b><u>EPS</u></b>	<b><u>Graphite</u></b>
<b>Line</b>	All shapes and attributes are maintained.
<b>Curve</b>	Curves convert into splines. All shapes and attributes are maintained.
<b>Fill</b>	All shapes and attributes are maintained.
<b>Fill/line</b>	All shapes and attributes are maintained.
<b>Non-fill/Non-line</b>	Not supported.
<b>Text</b>	Not supported.
<b>Weight</b>	Converts to the current weight.
<b>Color (white/black)</b>	Converts to the nearest of the first seven colors.
<b>Process color</b>	Convert to the nearest of the first seven colors.
<b>Custom color</b>	Converts to the nearest of the first seven colors.
<b>Pattern</b>	Converts to black fill.
<b>Layer</b>	Layer name and elements are retained. Layers that contain no elements are not retained.

## Export Command

The *Export* command in the File menu saves a document in the format specified.

1. Choose **File>Export**.

The Export dialog box appears.

2. Click the desired file type. To export only selected objects on the screen, rather than the entire document, click *Only Selected*.

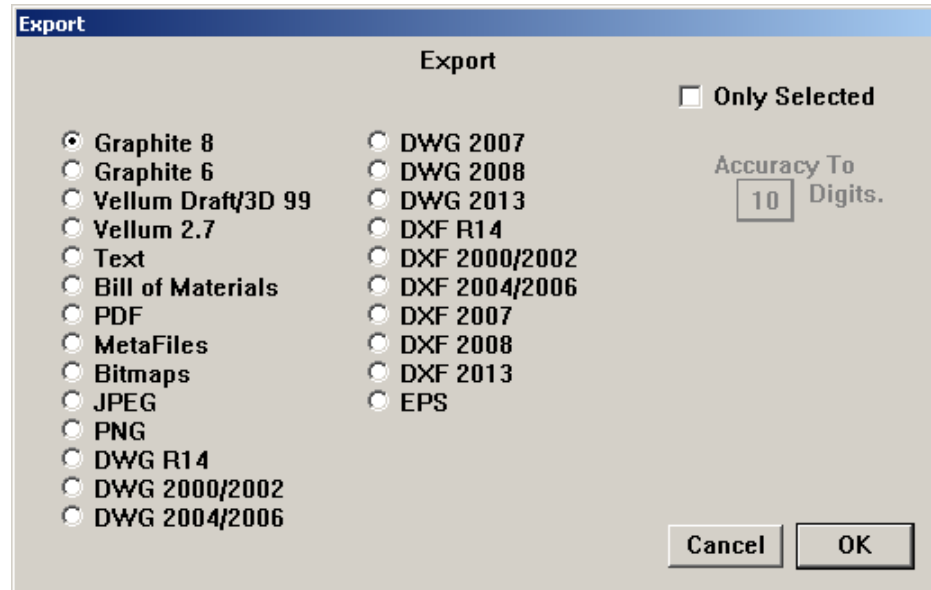

3. Click OK. The Export file dialog box appears.

The Export dialog box is identical in both appearance and function to the Save As dialog box. For Windows, filename extension indicates the type of export file.

### Types of Files

The following file types can be exported:

<b>Graphite and Vellum</b>	Ashlar-Vellum's native file format for current and previous versions.
<b>DXF</b>	AutoCAD's Data eXchange Format. R14 and ACAD2007 files can be exported.

---

<b>DWG</b>	AutoCAD's native file format. R14 and ACAD2007 files can be exported.
<b>IGES</b>	Initial Graphics Exchange Specification, version 4, the National Bureau of Standards format to standardize the exchange of graphics. The translator also includes the support of IGES entity 128 and 144 NURB surfaces and exporting an unlimited number of entities.
<b>TEXT</b>	ASCII characters. This option is available only if the <b>Text</b> tool is the active tool.
<b>Bill of Materials</b>	A listing of assigned attributes in an ASCII
<b>PDF</b>	Adobe's Portable Document Format
<b>META</b>	(Windows only) The format used by the Windows clipboard, is an interchange format specifically used for graphics commands. A document saved in this manner contains only the routines to reproduce the drawing as it appears on the screen.
<b>Bitmaps</b>	(Windows only) Microsoft Windows Bitmap file format.
<b>BMI</b>	CADAM BMI's file format.
<b>Pict</b>	(Macintosh only) Macintosh's Pict file format which uses object-oriented bitmaps or resolution independent graphics.
<b>EPS</b>	Encapsulated PostScript format for printing to a Postscript printer and for importing into compatible applications.

By specifying *Only Selected*, only the selected objects in the drawing are saved in the export format. If *Only Selected* is not specified, all objects are saved for export.

## PDF

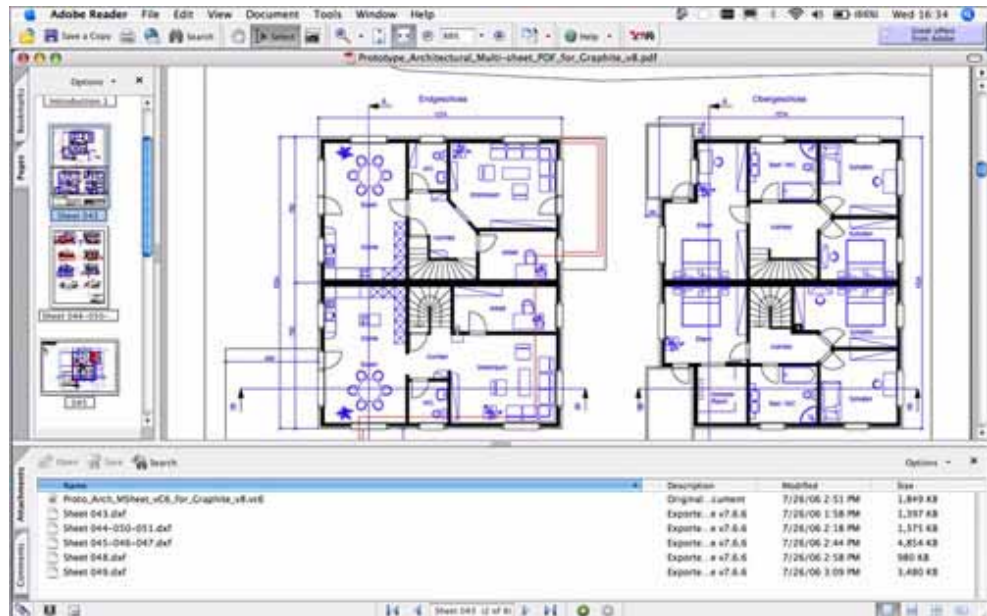

CAD files do not archive or email well and PDF files don't allow for further CAD editing or machining. It is possible, however, to create multi-sheet PDFs directly from within Graphite and embed *.dxf* and *.vc6* files directly in the file.

PDFs email easily and they accurately reproduce fonts, line styles and patterns, but allow no access to manipulate the source data for editing, printing or manufacturing.

Graphite's built in PDF writer has several advantages over the PDF maker built into the operating system. In Graphite it is possible to create multi-sheet PDFs drawn from multiple models in the same file. Optionally embed a Graphite file or a DXF export file directly in the file. Everything for an entire project can be emailed, displayed and archived.

Use Adobe Acrobat to further enhance the file, inserting and replacing pages, commenting and marking changes or tracking revisions.



### Creating a PDF in Graphite

1. Chose **File>Export**.
2. Select PDF from the Export dialogue box and click OK.
3. The Save File As dialogue box appears. Enter the name and location to save the PDF.
4. The PDF attachment box appears. Select which file to include and click OK.

### *How Exporting Affects Some Objects*

It is difficult to exchange data between different graphic programs because each program defines geometric objects differently. Even though the DXF and IGES formats standardize this exchange, some objects do not transfer exactly. For example, crosshatching is no longer associative although it does appear in exported files. The following table tells what to expect when exporting Graphite objects.

<b><u>Graphite</u></b>	<b><u>DXF</u></b>
<b>Crosshatching</b>	Supported.
<b>Detail views</b>	The view is lost, but the dimensions and text are retained.
<b>Diameter dimension</b>	The leader style may change.
<b>GD&amp;T symbol</b>	The feature control frame converts to non-GD&T symbol representation.
<b>Layers</b>	Layers are maintained.
<b>Lines with arrows</b>	Lines with arrowheads at the start and/or end are converted into lines and solids.
<b>Locked geometry</b>	The geometry is retained, but it is no longer locked.
<b>Line Weight</b>	AutoCad 2000 and higher only.
<b>Multiple sheets</b>	Each sheet must be exported individually.
<b>NURB splines</b>	Convert to splines.
<b>Radial dimensions</b>	The leader style may change.
<b>Smart Walls</b>	The double lines convert to symbol representation.
<b>Solid Fills</b>	Convert into solids.

---

<b>Symbols</b>	Convert into blocks.
<b>Tolerances</b>	The tolerance is lost, but the dimension remains.
<b>Graphite</b>	<b>IGES</b>
<b>Crosshatching</b>	Converts to symbol representation.
<b>Detail views</b>	The view is lost but the dimensions and text are retained.
<b>Diameter dimension</b>	The leader style may change.
<b>Fonts</b>	Fonts are not maintained.
<b>GD&amp;T symbol</b>	The feature control frame converts to a group of non-GD&T geometry.
<b>Grouped geometry</b>	The geometry is retained but it is no longer grouped.
<b>Layers</b>	The layers are lost but the geometry is retained.
<b>Locked geometry</b>	The geometry is retained but it is no longer locked.
<b>Multiple sheets</b>	Each sheet must be exported individually.
<b>Radial dimensions</b>	The leader style may change.
<b>Smart Walls</b>	The double lines convert to symbol representation.
<b>Text</b>	A multiple line note becomes many single lines.
<b>Graphite</b>	<b>EPS</b>
<b>Line</b>	All shapes and attributes are maintained.
<b>Circle</b>	Converts to a spline. All shapes and attributes are maintained.
<b>Arc</b>	Converts to plural connected paths (a maximum of 8 paths and 45 degrees). All shapes and attributes are maintained.
<b>Ellipse</b>	Converts to plural connected paths (a maximum of 8 paths). All shapes and attributes are maintained.
<b>Spline</b>	All shapes and attributes are maintained.

---

---

<b>Fill</b>	All shapes and attributes are maintained.
<b>Hatch</b>	Patterns are not maintained.
<b>Wall</b>	Line.
<b>Dimension</b>	Not supported.
<b>Text</b>	Not supported.
<b>Picts</b>	Not supported.
<b>Groups</b>	Group attributes do not convert.
<b>Layer</b>	Layer names, shapes, attributes and elements are retained. Layers that contain no elements are not retained.
<b>Color</b>	Converts to the nearest of the first seven colors.
<b>Weight</b>	Line weight converts to one point.
<b>Line patterns</b>	Not supported. All lines are converted into solid lines.

All geometry is exported as individual elements, except in the following circumstances:

- Fill geometry
- Grouped geometry

### ***EPS Translator***

This translator shares data between Graphite and other EPS applications. It was optimized for Adobe Illustrator 5.0J but works with other applications that support the EPS file format. This translator imports a postscript file into Graphite (text is not translated) and exports drawing data.

### Translator Notations

In postscript's expression, drawing data is described as a "path." 2D drawing data is expressed by the values given for the path from the startpoint to the endpoint. Straight lines and Bezier curves create such paths.

For example, a circle contains the following components:

- 4 connected Bezier curves (in Adobe Illustrator the path is structured by anchor points (startpoint, centerpoint and endpoint) and segments). If the circle is created using one tool, then the anchor points are connected.
- Path width: user-defined units or points (1pt=0.35 mm)
- Path Color: user-defined
- Fill inside Startpoint-Endpoint: user-defined
- Fill Color: user-defined

### CADAM BMI Translator

The CADAM BMI translator shares data between Graphite and CADAM. The translator converts this data, using the BMI format, into a neutral file format of CADAM.

All recognizable entities will be converted with their attributes. For unrecognizable entities, only the shapes will be converted.

The translator works according to the graphic below.

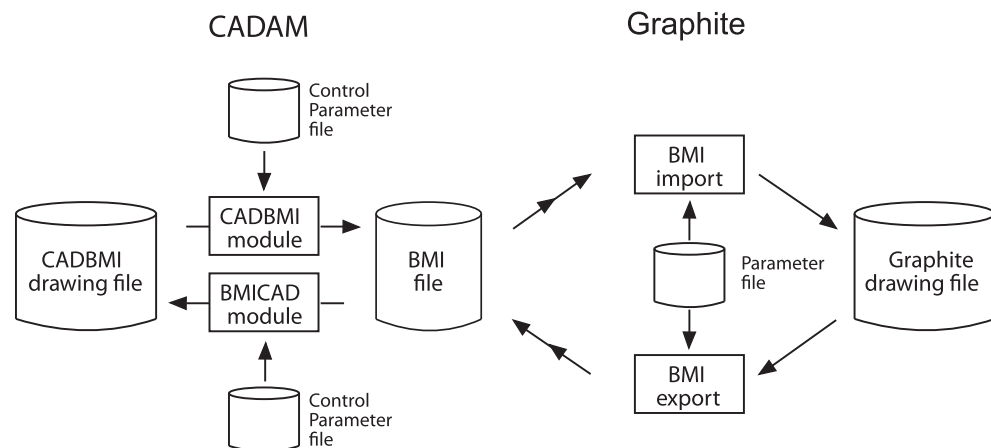

The VelBmi.ini file is the Control Parameter file. This parameter file is used in the translation of the geometric entities in the drawing.

### Tips for the Best Possible Translation

In general, it is recommended to show all the layers before exporting from Graphite or any other CAD package to know what objects are exporting.

- Graphite was designed to export only the current model. If there are Detail Views in the file, flatten them with the *Flatten View* command found in the Views menu. If dimensions already appear in the detail view and the view scale is set to 1, group the dimensions and geometry together before flattening the view. This brings the dimensions across to the current model for Export.
- Graphite supports 256 layers. If a DXF file contains more than 256 layers, the geometry that is on the additional layers is automatically placed on the current work layer in Graphite. If this is not desirable, reduce the number of layers to maximum of 256 in the application where DXF file is being created.
- Attributes in an AutoCAD file do not come into Graphite as text because Graphite does not support that entity type. To bring the attributes into Graphite via DXF, convert those attributes to Text before Exporting from AutoCAD.
- If, when translating to AutoCAD, the line patterns do not seem to come across or are distorted (too big or too small), change the AutoCAD variable *LTSCALE* to a smaller number to display the line patterns at an appropriate scale.
- With some angular dimensions, the arrow may be displayed in AutoCAD in the wrong direction (pointing towards the text rather than towards the extension lines). If this happens, execute the *DIM* command in AutoCAD, select the affected dimensions, and use the *UPDATE* command to display the arrow correctly.
- To export from Graphite to Illustrator, use the EPS format. Be aware that dimensions, text, and .pict and .bmp images are not supported by EPS in this process. Remember that EPS does not support 3D data. It will translate all data to the top view, unless the 3D data is flattened before exporting as EPS. If text and dimensions are needed for Illustrator, export using the DXF format or print to Post Script. Usually the easiest way to get simple data into Illustrator is to highlight it in Graphite, then copy it to the clipboard and paste it into Illustrator.
- We recommend using DWG for translating data between Graphite and Pro/E.
- DWG is the preferred method of translation between Graphite and SolidWorks.

## Convert Command

This command in the File menu starts the Convert batch translator importing and exporting multiple files in an unattended mode. It imports all files of the same type from one folder and saves these files in the selected format into a destination folder.

### Converting Multiple Files

1. Create two folders.

One folder is used to store the original files (the FilesIn folder), the other folder stores the converted files (the FilesOut folder).

2. Copy all files to convert into the FilesIn folder.

3. Select the **File>Convert**.

The Multiple File Translation dialog box appears.

4. Select the file type being translated from the *Input File Format* column.

5. Select the file type being translated from the *Output File Format* column.

6. Check the *Draw each file* option, if desired.

Mark this option to see each file during the conversion process. If this option is not selected, Graphite opens a blank drawing window, performs the conversion, closes the blank window and repeats the process for each file in the folder.

For large drawings or large quantities of drawings turning off

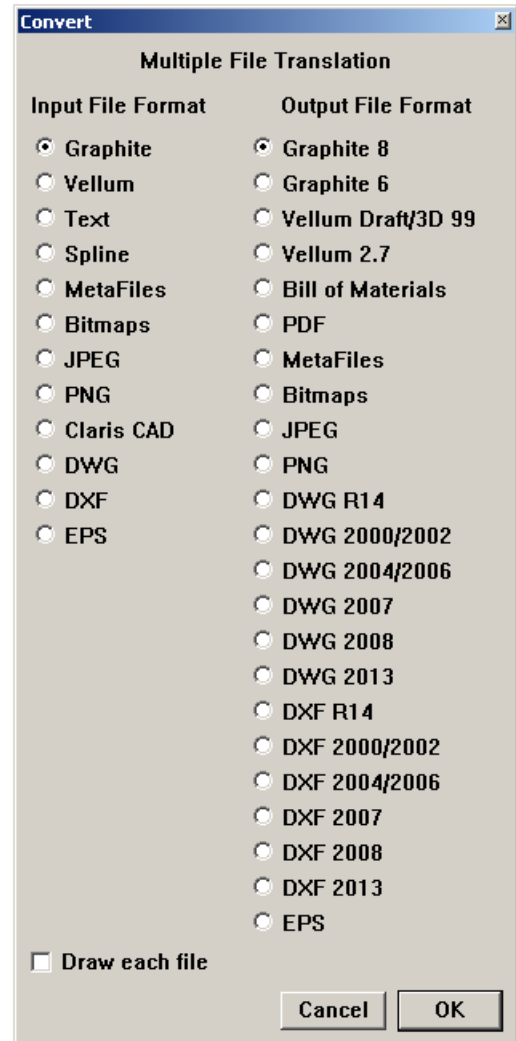

*Draw each file* speeds up the operation.

7. Click OK.

The Open file dialog box displays.

8. Open the folder (FilesIn) that contains the files to convert.

9. Select a single file and click Open.

The selected file must be of the same type as was selected for *Input File* format or Graphite generates an error message.

10. Select a destination folder (FilesOut) for the translated files or create a new one.

Specify a new extension to identify the converted files (it is reasonable to use the standard file type extension like *.dxf* for DXF files or *.igs* for IGES files.

This is not necessary for the Macintosh but may help in file organization.

Graphite will convert every file from the Input folder that is of the same type.

Select a Graphite file in the Input folder, and requested convert to DXF, Graphite converts every Graphite file in that folder to DXF, and places those DXF files in the Output folder selected. If the folder also contains IGES files, they are not translated.

Specify DXF as the *Output file* format, Graphite asks once to convert thick lines to be Polylines. Whatever is specified is valid for all DXF Files in that folder.

## Drawing at Full Scale

Whether designing or drafting a highly detailed blueprint, create the geometry at its actual size. Graphite enables constructing the part using full-scale specifications and then setting the visual scale of the drawing. In this way, the part dimensions to its true-to-life measurements. Drawing at full scale has the following advantages:

- Scaling mistakes are eliminated.
- Dimensions are automatic (dimension manually if not drawing at full scale).
- Associative dimensions update when the object is edited (manual dimensions do not).
- The size relationship of imported parts is compatible.
- Calculations for 2D analysis are accurate. (See Chapter 18 for more information.)

Once the project is drawn, it can be dimensioned, scaled it visually, and sized to fit into a standard drawing format, if needed. The actual size of the geometry remains constant unless edited.

When opening a new Graphite document, the drawing area is a sheet that is infinitely large to design anything at full size. For a simplistic example, here's how to draw and view a line 83 feet long:

1. Draw a line, specifying **83'** for the length.

The line extends off the screen.

2. Choose **Arrange>Zoom All**. The entire 83 foot line is visible on the screen.

Using the draw to scale/Zoom All method, create accurate full-scale drawings which are displayed at the magnification chosen.

**Reminder:** The actual size of an object is not affected by zoom magnification or reduction.

## Scaling Line Patterns and Crosshatch Patterns

If the unscaled construction is very large or very small compared to the size of added text and dimensions, line patterns and crosshatch patterns are inappropriately sized. By setting the scale for the drawing with the *Drawing Size* or *Sheet Into View* command, line patterns and crosshatch patterns are automatically scaled with the inverse scale factor specified. The patterns appear at the appropriate size for the view scale of the geometry.

### *Tech Note:*

*Zoom All* magnifies or reduces all objects on a drawing to fill the screen—regardless of how big or small the objects are.



## Scaling Text and Dimensions

If drawing objects that are scaled visually, text, dimensions, line patterns and crosshatch patterns behave, when scaled, differently than the geometry created. While geometry always scales with the specified scale factor, text and dimensions scale with the inverse scale factor set with the *Drawing Size* or *Sheet Into View* command.

While the inverse scale factor applies immediately to line patterns and crosshatch patterns as described in the section above, the inverse scale factor applies only to future text and dimensions added after scaling. Existing text and dimensions scale with the same scale factor as the object geometry. A 12 pt. text that was created at a 1:1 drawing scale is 24 pt. on a page printed at a 2:1 scale. The size of the text does not change relative to the other geometry in the file.

To keep the text size specified before scaling, choose the *Keep Text Size* and *Keep Dimension Text Size* options in the Drawing Size dialog box. This changes the size of the text relative to other geometry in the file. For example, 12 pt. text that was created at a 1:1 drawing scale is still 12 pt. on a page printed at a 2:1 scale. The size of the text is half as small as before changing the drawing scale, relative to other geometry.

Another method of controlling text size and dimensions while scaling is to calculate the needed text size manually as shown in the following example.

When calculating the text size for scaling manually the rule is: set the text size to the inverse of the scaling factor. (The text size affects both text and dimensions.) In that way, the text elements of the drawing are proportional with the size of the geometry.

For example, if an assembly is 83 feet wide, scale that assembly 1:100 (a scale factor of .01) to place it in a drawing format. This requires using text that is equally large to read it visually when scaling the drawing. The final text to be .156 inch in height, specify 100 x .156 for the text size in the drawing. With the manual calculation make this specification before beginning dimensioning or annotating.

### *Tech Note:*

When scaling smaller, multiply the text size by the scale factor. If scaling larger, divide the text size by the scale factor.

## Scaling Text and Dimensions Manually

1. Choose **Text>Size>Other**.

The dialog box displays the measurement of the text.

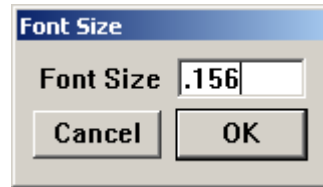

The Font Size is set to .156 inch.

2. Click after the entry in the data field.  
The text cursor blinks in the data field.
3. Enter **\*100** and click OK.

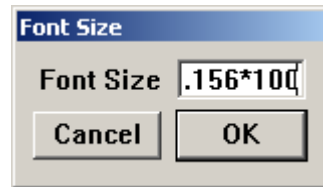

Subsequent text and dimensions are one hundred times the original size, or 15.6 inches. When adding dimensions, the text size is appropriate for the part.

### *Tech Note:*

The relationship between the object and the text should appear normal when zoomed. If it looks right, it is right.

## ***Drawing Scale and Paper Size***

When the design is ready to be detailed with line patterns and dimensions, or to print or plot the design, scale the view of the drawing to fit the paper used.

Specify a printer or plotter, the paper format and orientation, and then the drawing size for the specified format.

## **Print to PDF**

Graphite's built in PDF writer has several advantages over the PDF maker included into the operating system, such as embedding source and other target export files. It also supports multiple sheet drawing.

## Print Setup (Windows); Page Setup (Macintosh)

The *Print Setup* or *Page Setup* command in the File menu sets the page size, orientation and other options.

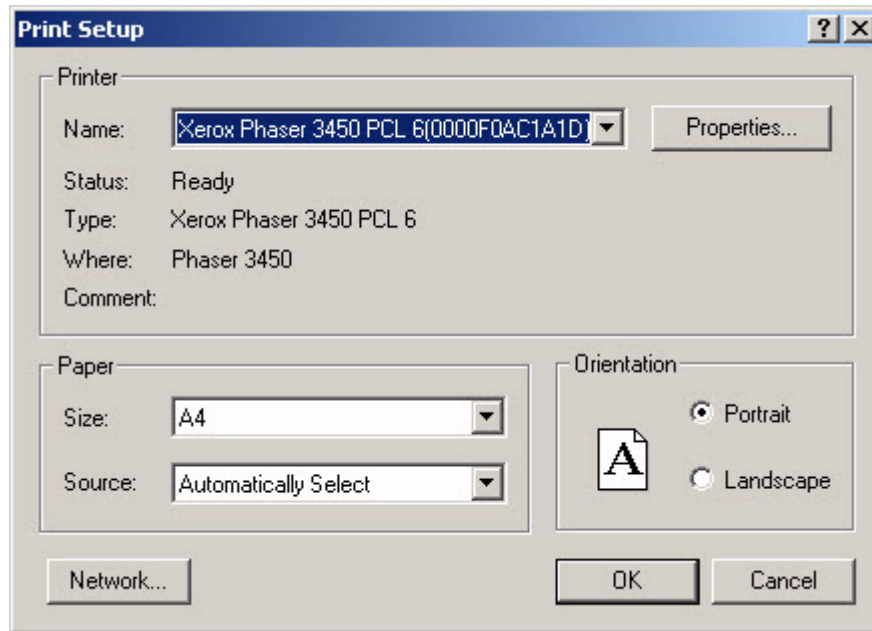

### Setting up the Page

1. Select the plotter or printer.
2. In the Paper Size menu, select the paper size.
3. Specify the orientation.

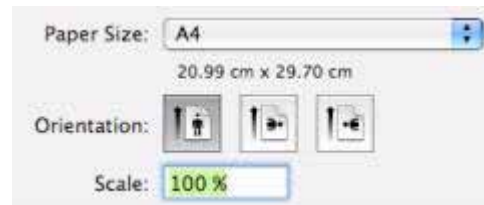

### Drawing Size Command

The *Drawing Size* command in the Layout menu shows the size of the maximum plotting/printing area relative to the drawing. It also specifies the scaling of the drawing so it fits the paper size and orientation set by the *Print Setup (Windows)* or *Page Setup (Macintosh)* command. The Drawing Size window has two tabs: Printing and PDF Exporting.

## Setting Up the Drawing Size for Printing to Paper

If the geometry is larger than a standard piece of paper, or so small that it would be impossible to use it at full scale, set the Drawing Size. In many cases, it may be desirable to use a standard drawing scale (such as 1/4 inch = 1 foot) for the drafting project.

1. Choose **Layout>Drawing Size**. A dialog box appears.

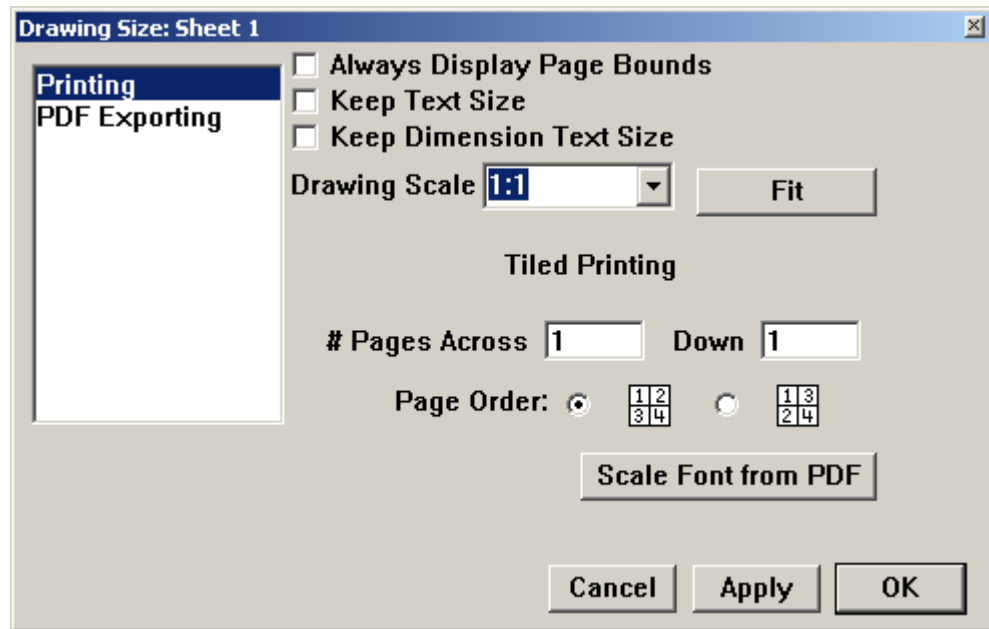

2. Select Printing from the list.
3. Specify the scale, using one of three methods below as necessary:
  - Click the *Drawing Scale* data field and enter a scale ratio (Plotted Size: Actual Size). Enter real values, such as **0.25" : 1'**, which Graphite converts to 1:48. Click Apply to see the effect of the scaling.
  - Or press the arrow beside the *Drawing Scale* data field and choose one of the standard ratios from the menu. Click Apply to see the specified scaling.
  - Or click the Scale Font from PDF button to copy the text scale from the PDF Exporting tab if preferred. Make sure that the Keep Text Size option is checked to enable this functionality. Click Apply to see the result of scaling.

The Cancel button on the Drawing Size dialog box doesn't abort changes if Fit or Apply were chosen first.

### Tip:

When scaling the drawing, text and dimensions behave differently from the geometry created as described under the "Scaling Text and Dimensions" section earlier in this chapter.

If a specific scale is not needed, click Fit to scale the drawing to fit the paper.

With any of these methods, the geometry itself does not change scale on the display; it only changes visually, not physically.

4. When printing multiple sheets and taping them together, follow the directions for “Tiled Printing” on page 15-34 later in this chapter.
5. Click OK.

### Setting Up the Drawing Size for Exporting to PDF

PDF is basically electronic or virtual paper with some of the same issues as actual paper. There are separate settings for Exporting to PDF because sometimes you'd like to use a different paper size than is supported by your printer.

1. Choose **Layout>Drawing Size**. A dialog box appears.

*Note:*

This is NOT the same as Print to PDF. You may still Print to PDF by configuring PDF printer software from an appropriate supplier.

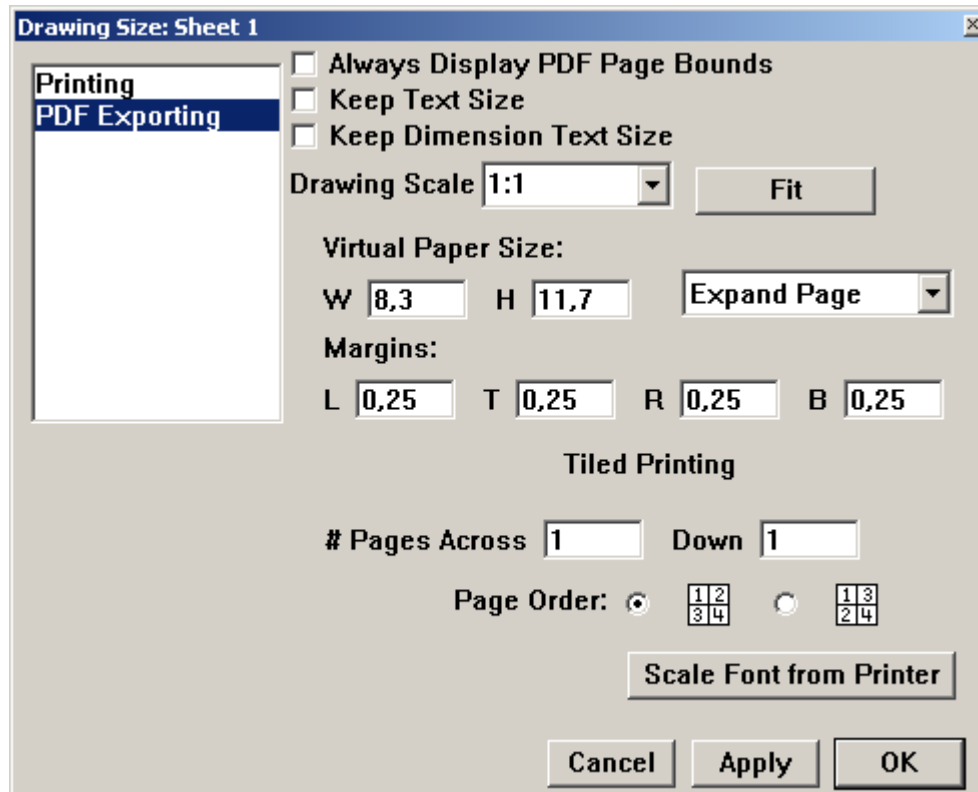

2. Choose the PDF Exporting tab.

*Tip:*

When scaling the drawing, text and dimensions behave differently from the geometry created as described under the "Scaling Text and Dimensions" section earlier in this chapter.

3. Specify the width and height in the *W* and *H* data fields or click the down arrow in the data field on the right to choose one of the predefined sizes. Set the margins for the left, top, right and bottom edges of the page in the *L*, *T*, *R*, *B* data entry fields.
  - Click the *Drawing Scale* data field and enter a scale ratio (Plotted Size: Actual Size). Enter real values, such as **0.25" : 1'**, which Graphite converts to 1:48. Click Apply to see the effect of the scaling.
  - Or press the arrow beside the *Drawing Scale* data field and choose one of the standard ratios from the menu. Click Apply to see the specified scaling.
  - Or click the Scale Font from Printer button to copy the text scale from the Printing tab if preferred. Make sure that the Keep Text Size option is checked to enable this functionality. Click Apply to see the result of scaling.

The Cancel button on the Drawing Size dialog box doesn't abort changes if Fit or Apply were chosen first.

If a specific scale is not needed, click Fit to scale the drawing to fit the paper.

With any of these methods, the geometry itself does not change scale just the display; it only changes visually, not physically.

4. When printing multiple sheets and taping them together, follow the directions for "Tiled Printing" on page 15-34 later in this chapter.
5. Click OK.

*Referral:*

An exact description of the *Sheet Into View* command is in the Chapter 15 "Tiled Printing."

### ***Setting the Visual Scale with the Sheet Into View Command***

Once a full-scale part has been drawn and dimensioned, then create a visually-scaled view of that part. The *Sheet Into View* command performs the details of this operation automatically.

1. Choose **Arrange>Zoom All**.  
All objects are displayed on the screen.
2. Choose the **Views>Sheet Into View**.
3. Enter the scaling value in the *Scale* data field of the Sheet Into View dialog box. Figuring this value is similar to drafting on paper, determining which scale to use so that the finished part fits on the paper size.
4. Click OK.

The part is now in an independent view, scaled as specified.

Scaling does not change the actual dimensions of the part. Verify this by selecting an object and then looking at the specifications of that object in the Edit Objects dialog box.

## Printing/Plotting Region

Select **Layout>Drawing Size** and then click *Always Display Page Bounds*. A gray rectangle appears in the drawing area. This rectangle represents the printing/plotting region of the page to show how the drawing fits the paper. The plotting region is smaller than the actual page size because most printers and plotters cannot plot to the edge of the paper. For the plottable outline not to show all the time, uncheck *Always Display Page Bounds*.

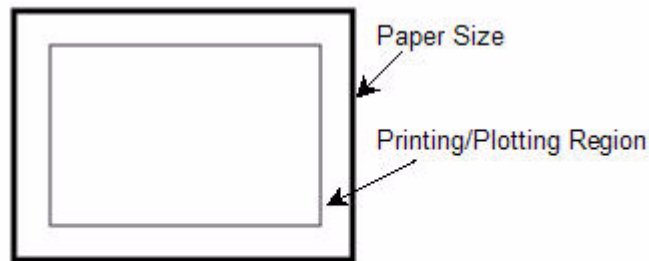

Graphite displays the Printing/Plotting region

The size of this region is based on the paper size and the printer or plotter drive currently selected.

When the boundary of the printing/plotting region appears, drag the boundary rectangle around the drawing area with the *Hand* pointer, as shown above. The cursor becomes the Hand pointer when the cursor is moved outside of the dialog box.

To change the paper orientation while the Drawing Size dialog box is visible, choose **File>Print Setup** (Windows) or **Page Setup** (Macintosh) and enter the specifications. The new specifications appear in the drawing area.

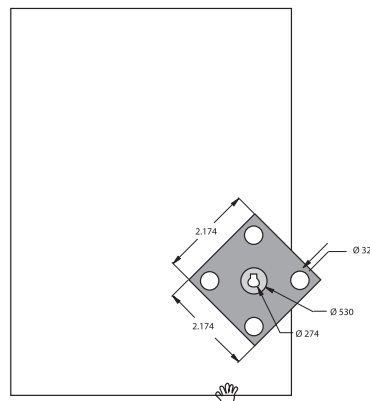

### *Tech Note:*

The location of the Layout file for the drawing formats varies with the version of Graphite, the platform and the version of the operating system. It can be found under User, Workgroup, System (Mac only) and/or Program. For specific information on your version try the knowledgebase in the Support Center on the website at [www.ashlar.com](http://www.ashlar.com).

### *Tech Note:*

It is only possible to pan when the Drawing Size dialog box is open. Once closed it is no longer possible to adjust the boundaries through panning.

## Tiled Printing

When using a printer rather than a plotter, it is possible to tape pages together to get a larger drawing than laser printers allow. Specify the layout for those pages by choosing **Layout>Drawing Size**.

1. Choose **Layout>Drawing Size**.
2. Specify the number of pages *Across* for the final drawing.
3. Specify the number of pages *Down* for the final drawing.
4. Specify the order for printing the pages (Across then Down or Down then Across).

Across then Down

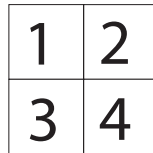

Down then Across

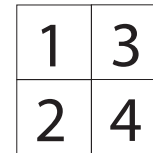

5. Click Fit.
6. Click OK.

The drawing scales to fit the number of pages and layout as specified.

### Preview Layout

The *Preview Layout* command in the File menu shows the size and orientation of the printing area specified in *Print Setup* (Windows) or *Page Setup* (Macintosh) by displaying a black border. If a printing/plotting size is not specified, the default size is used. To remove the page border display, select the command again or simply select a tool from the tool palette.

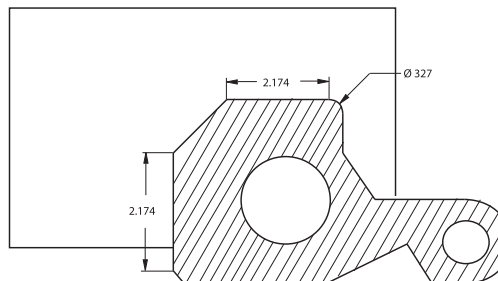

If the drawing does not fit the paper size, choose **Layout>Drawing Size**.



## Drawing Formats

When a part is complete and ready to be placed in a formatted border, Graphite provides many options. Not only can all drawing formats be modified in the Layout folder, but it is also possible to create your own drawing formats and design layouts as well.

Graphite distinguishes between *Drawing Formats* and *Design Layouts*. Drawing formats contain the *border line* of the drawing, the *cutting line* and a *Title block* for entries such as *name* and *scale* of the drawing. Design layouts contain a border and detail views.

- Drawing formats have to be created for each paper format such as A, B, C or D and for both paper orientations Portrait and Landscape.
- All drawing formats found in the Layout folder are designed for Plotter devices, where the cutting lines correspond exactly with the dimensions of the selected paper format (for example 30 x 40 inch for the D Format) and the Border line is offset inside by a half inch according to the ANSI standard.
- When using these plotter formats for a laser printer it is necessary to adjust them to the printing area of the printer, since they often differ from printer to printer.
- Design layouts contain, in addition to the drawing format, one or more detail views that may display with the *Sheet Into View* command the content of a drawing at different view angles and scale factor.

### *Tech Note:*

The location of the Layout file for the drawing formats varies with the version of Graphite, the platform and the version of the operating system. It can be found under User, Workgroup, System (Mac only) and/or Program. For specific information on your version try the knowledgebase in the Support Center on the website at [www.ashlar.com](http://www.ashlar.com).

## Placing Drawing Formats

Graphite places *Standard Drawing Formats* using two different commands:

- The *Import* command in the File menu.
- the *Sheet Into View* command in the Views menu.

### ***Using the Import Command***

If a part is placed in a detail view and visually scaled, it is possible to import a standard drawing format (either one of those supplied by Ashlar-Vellum or a custom format) in preparation for printing or plotting. Since the format should be full scale, it must be imported onto the sheet outside the view because the detail view is scaled and the sheet is not.

1. Choose **Layout>Drawing Size** to scale the drawing.

The **Drawing Size** dialog box displays.

2. Mark the *Always Display Page Bounds* option to compare the true size of the drawing with the displayed printing area of the drawing format.

3. Choose the **File>Import**.

The Import dialog box displays.

4. Mark the *unscaled* option.
5. Select a desired drawing format under your language in the Layout Folder on your system. See the Tech Note on locating the Layout Folder. For example: *ViewB.vc6* (Windows) or a *Format B & View* (Macintosh) where **1View** stands for one detail view and **B** for the paper format.

**Important:** Ignore the number of detail views since they are only important when using the *Sheet Into View* command.

6. Click OK.

#### *Tech Note:*

The location of the Layout file for the drawing formats varies with the version of Graphite, the platform and the version of the operating system. It can be found under User, Workgroup, System (Mac only) and/or Program. For specific information on your version try the knowledgebase in the Support Center on the website at [www.ashlar.com](http://www.ashlar.com).

### ***Using the Sheet into View Command***

With the *Sheet Into View* command, Graphite imports not only a drawing format but also displays the drawing at the specified scale in one or several detail views, depending on the selected design layout.

1. Choose the *Sheet Into View* command in the Views menu.

The Sheet Into View dialog box displays.

2. Select the desired drawing format from the *Layout* list box, such as:

B Landscape 4 Views.vc6

where B Landscape stands for the paper size and orientation, and 4 Views designates the number of detail views.

3. Enter the desired scale factor in the *Scale* data field.
4. Click OK.

The drawing format is placed at a scale of 1:1 (at its true size) onto the drawing area and the complete geometry of the drawing displays in one or several detail views at the specified scale factor. The number of detail views and the view angle (Top, Isometric, etc.) depends on the selected design layout.

### **Modifying Drawing Formats**

All drawing formats included with Graphite in the Layout folder can be modified. To create custom drawing formats it is recommended to modify existing formats and save them under a new name.

## Creating Drawing Formats and Design Layouts for Laser Printers

1. From the Layout folder the drawing format:  
B Landscape 1 View.vc6  
  
where B Landscape is the paper size and orientation and 1 is the number of detail views.
2. Save the drawing under a new name.
3. Choose **Layout>Drawing Size**.  
The Drawing Size dialog box displays.
4. Mark the *Always Display Page Bounds* option.  
The Printing area of the active printer displays as a gray rectangle.
5. Click OK.  
The Drawing Size dialog box closes.
6. Select the grouped drawing format on the drawing area and ungroup the format by choosing **Arrange>Ungroup**.
7. Adjust the border lines of the drawing format until they are placed exactly on top of the displayed gray rectangle for the printing area of the printer.
8. Delete all cutting lines since they are not required for printing.
9. Hide the Forms layer.  
All Text Entries are hidden. See the next section for information about title blocks and text entries.
10. Select the complete drawing format by choosing **Edit>Select All** and group the format by choosing **Arrange>Group**.  
**Important:** Text entries with an @ character in front must not be grouped since then the *Forms* command cannot identify these entries as title entries (see a later section, "Creating Forms").
11. Activate the Forms layer.
12. Save your work.

### Tech Note:

The location of the Layout file for the drawing formats varies with the version of Graphite, the platform and the version of the operating system. It can be found under User, Workgroup, System (Mac only) and/or Program. For specific information on your version try the knowledgebase in the Support Center on the website at [www.ashlar.com](http://www.ashlar.com).

## Forms

Use **Text>Forms Text** to display the Forms dialog box. Fill in text or values for the title blocks of all standard drawing formats that are saved in the Layout folder. Customized drawing formats can be used with the *Forms* command. This is described in a later section of this chapter.

As long as no standard drawing format is placed in a drawing, the *Forms* command is not available. It can be selected only if a drawing format with a title block is placed in the File menu using the *Import* command or the *Sheet into View* command in the Views menu.

### Creating Forms

Before using the *Forms* command in the Forms Text submenu to fill in customized drawing formats, the title blocks of these formats must be prepared.

To enable Graphite to identify the title blocks, define *fields* in the drawing format. To define a field, create a regular text block, and type an @ character in front of the text. Any text following an @ character then becomes a field. For example, to create an entry field for *Scale* create a text block and type “@Scale” in the box. For a label in front of the field, create another text block without an @ character. The following illustration shows two text blocks. One is the label (a standard text block), one is the field (a text block beginning with @).

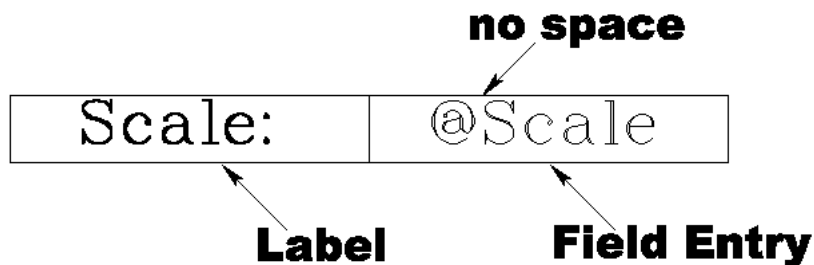

**Note:** All field and label text blocks have to be placed on the Forms layer. (Create this layer using the *Layers* command as discussed in Chapter 13.)

### ***Preparing Title Blocks with the Forms Command***

1. Open one of the drawing formats in the Layout folder.
2. If no layer with the name Forms exists, create this layer by choosing **Layout>Layers** and make it the current layer.
3. Select the *Text* command from the function palette.
4. Create text blocks. Any text block beginning with an @ character will become a field, all others will become labels.
5. Assign to all of the text blocks the desired font, style and size using the **Selection** tool from the tool palette.
6. Save the drawing format.

### **Using Forms**

With a format already placed in the drawing, selecting the *Forms* command in the Forms Text submenu brings up the Forms dialog box. This dialog box is similar to the Resolve dialog box in that it prompts the user for values for each previously defined field. Graphite replaces the field text blocks with whatever values are entered. Text attributes, such as font, assigned in the saved format are applied to the new values.

### ***Filling in a Form***

1. Place a Standard drawing format (use the *Import* or *Sheet into View* command). The form appears with all of the field labels as they were originally created.
2. Choose the **Text>Forms Text>Forms**.  
The Forms dialog box containing all entry fields of the title block displays.
3. Type in the desired parameters. All entry fields need not be filled.
4. Click OK.  
The Forms dialog box closes and all entry fields of the selected title block are filled in according to your specifications.

### ***Editing Title Blocks***

1. Select the fields containing values to update (or choose ***Edit>Select All***).
2. Select the ***Text>Forms Text>Forms***.  
The Forms dialog box displays again.
3. Modify the entries of the title block.
4. Click OK.  
The Forms dialog box closes and the selected title block is modified accordingly.

## ***Printing or Plotting a Drawing***

Graphite prints and plots on most printers and plotters. Follow the manufacturer's instructions for installing and setting up the printer or plotter, then size the drawing for the paper.

### **Setting the Printer or Plotter and Paper Specifications**

In the File menu, use the *Print Setup* (Windows) or *Page Setup* (Macintosh) to specify the printer or plotter, the paper size, orientation, number of copies and other options.

Once the page setup is specified, set the visual scale of the geometry so that it fits the paper size.

Follow the instructions found earlier in this chapter to scale the geometry visually to fit the paper specified in *Print Setup* (Windows) or *Page Setup* (Macintosh).

## Print Command

CTRL+P (Windows); ⌘+P (Macintosh)

The *Print* command in the File menu, or the last icon in the **Window>General** palette, prints or plots the current document as specified in *Print Setup* (Windows) or *Page Setup* (Macintosh).

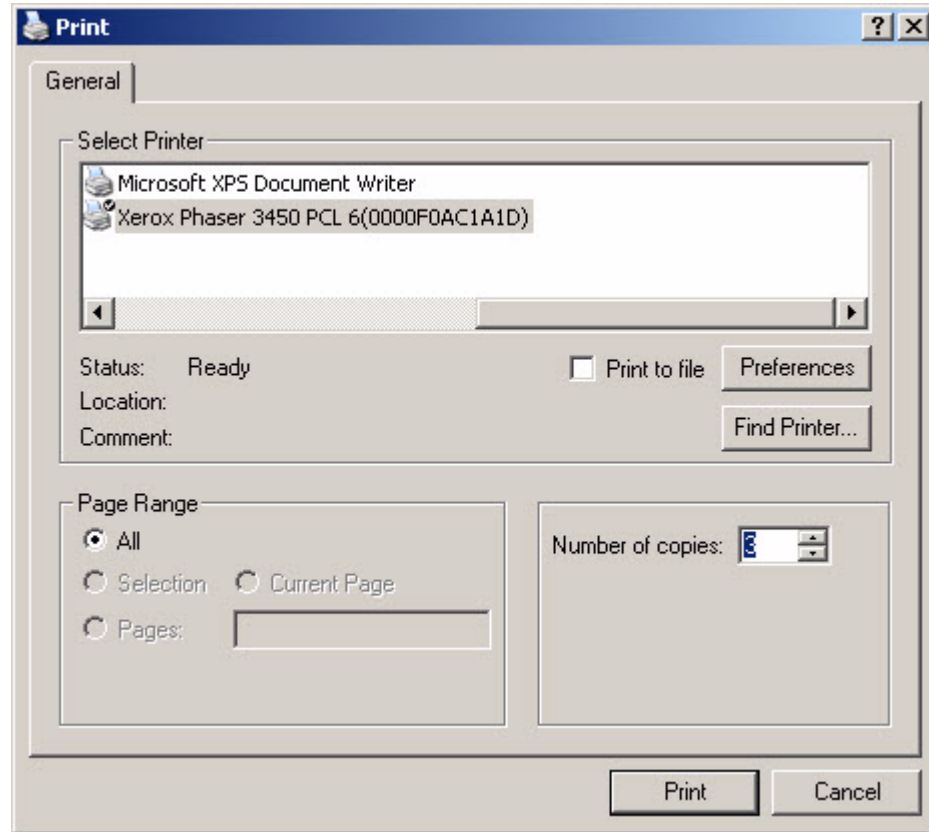
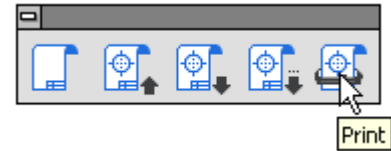

The area printed or plotted is the portion that fits on the page size specified in *Print Setup* (Windows) or *Page Setup* (Macintosh) when the origin (0,0) is placed in the center of the page. Choose **Layout>Drawing Size** to scale the drawing to the appropriate size and reposition the print/plot region.



Specify tiling (printing on several pages to be pasted together) through the *Drawing Size* command. If there is more than one sheet or tiling is specified, it is possible to designate which page(s) to print/plot. Pages are numbered sequentially for tiling, then for additional sheets.

### ***Plotting to a File***

It is also possible to plot to a file rather than to a plotter or printer. In that way, a plotter does not need to be attached to the computer. Someone else can plot the drawing without having a copy of Graphite on the plotter's computer.

The type of plotter chosen when setting up the page determines the format of the plot file.

By choosing a PostScript printer, the file format will be Encapsulated PostScript; and the HPGL language is used when Hewlett Packard plotters are selected. The computer that finally plots the file must have an application compatible with the file format of the printer or plotter.

### ***Plotter Fonts***

When you are using a plotter, specify the Plotter font for the text and dimensions on the drawing. It is also possible to specify different text styles (such as italic or bold) in the Text menu and generate special characters and accents as described in Appendix B.



# Parametrics

Graphite's integrated parametrics feature creates geometry without regard to its actual measurements. When the geometry is resolved parametrically, values are specified for the dimensions and Graphite redraws the geometry to the specifications provided. One example of parts that are well-suited to parametric definition are containers that vary in size according to the needs of a product line. Another might be hydraulic pistons that vary in size because of the duty loads. Still another might be valves that vary according to the diameter of the pipes to which they are attached.

This parametric feature is the basis for creating symbols to be used in drafting on a regular basis. See the next chapter for more detailed information.

The following topics cover the parametrics feature:

- Introduction to Parametrics
- Using Parametrics
- Parametric Drafting
- Parametric Problems
- Complex Parametric Drafting
- Parametrics and Grouped Objects

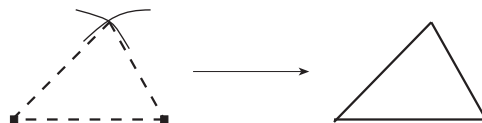

## Introduction to Parametrics

In its simplest form, parametrics allow the creation of a shape and then the specification the exact measurements. Take, for example, the basic activity of constructing triangles using parametric geometry.

1. Create the geometry.
2. Dimension the geometry using variables, constant values, and expressions. As many as 253 parametric dimensions can be used.
3. Resolve the parametric geometry.

Using this method, it is possible to quickly draw a triangle to exact specifications.

Of course, parametrics can be much more complex when using variables, as

seen later in this chapter. While creating geometry is straightforward, when a part becomes complex, parametric dimensioning requires some skill and comprehension of how Graphite treats geometry.

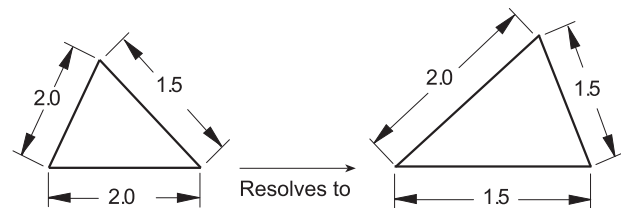

## Using Parametrics

### Tip:

The Graphite folder contains a folder of symbols that use parametrics. You might retrieve a few of the symbols by going to the File menu to the Symbols submenu and choosing the *Insert* command to become familiar with how parametrics works. See the next chapter for more information on symbols.

The parametric mechanism is *point-driven*. It locates the points and then connects them with the appropriate geometry, much like the childhood activity of *connect-the-dots*. It is not unlike drawing with a compass, triangle, and T-square.

To begin, determine where the endpoints are and then draw lines to connect the points. Or figure out where the center of an arc should be, where the arc begins and ends, and use a compass to connect the points.

## Basic Rules

1. Define the geometry completely.

Each object must relate to another object.

Dimensions must define every aspect of the geometry. (The geometry may be over dimensioned according to standard drafting practice.)

Do not include extraneous text as part of a dimension. (A single # is acceptable. The parametric mechanism recognizes R # to mean a radius, measuring the real value of the geometry.)

2. Keep it simple. If the part is complex, construct small segments, resolving as you go, solving any parametric problem before proceeding.
3. Return to the original part between tests. Use the *Undo* command to revert to the original state of the parametric part between tests. In this way, an unwanted constraint won't be introduced.
4. Consider the following assumptions made by the parametric mechanism:
  - Horizontal and vertical lines maintain their orientation.
  - Connected lines remain connected.
  - Lines tangent to arcs remain tangent (if there is an endpoint at the tangency point).
  - Colinear lines remain colinear if they overlap or share endpoints.
  - Concentric arcs remain concentric.
  - A point of an object on a horizontal or vertical line will remain on that line.
5. Be aware of the relationships that the parametric mechanism cannot recognize:
  - Parallel lines may not remain parallel.
  - Perpendicular lines may not remain perpendicular.
  - Symmetrical geometry may not remain symmetrical.

## Creating Geometry

When approaching the problem of resolving geometry, evaluate it as if drawing it on paper. Remember the assumptions and requirements for geometric relationships as outlined in the previous Basic Rules section.

## Parametric Dimensions

The essence of parametrics is in the dimensions. The dimensions may be the actual value (gotten by default), a constant which is not the actual value, a single variable, or an algebraic expression involving constants, variables, mathematical operators, functions, and conditional operators.

Constants are specific numeric values, such as specifying a radius as .25 (inch). Variable expressions may be as simple as a single letter such as  $L$  (for length), or a mathematical expression such as  $2 * Dia$  (where  $Dia$  may be the diameter). The arithmetic operators are *addition* (+), *subtraction* (-), *multiplication* (\*), *division* (/), *mod* (the remainder after division—%), and *exponentiation* (\*\*). See Appendix A for a list of functions and conditional operators.

In whatever way the dimensions are specified, they must define all geometry and any relationships that exist between different parts of the geometry.

### ***Creating Parametric Dimensions***

1. Construct the geometry.
2. Display the dimension palette and choose the appropriate dimensioning tool.  
The Status Line displays a # symbol in the text data field to show that the dimensions are entered as actual measurements.
3. Click the geometry to dimension as usual.  
The Text data field in the Status Line highlights.
4. Type whatever expression, variable, or constant to be used for the dimension, and press the ENTER (Windows) or the RETURN (Macintosh) key. To use the actual value, do not overwrite the # symbol in the text data field.

Variables are case sensitive:  $D$  is not the same as  $d$ .

The expression typed replaces the # symbol.

### Examples of Parametric Dimensions and Conditional Expressions

Use the conditional operators as parametric dimensions. Create the dimension as usual and enter the conditional expression as text in the Status Line.

The example here shows a conditional *ifelse* expression.

When the above *ifelse* statement resolves, the rectangle with the larger value (L1 or L2) touches the L3 rectangle.

The length represented by the *ifelse* expression equals L1 because L1 is greater than L2.

The length represented by the *ifelse* expression equals L2 because L2 is not less than L1.

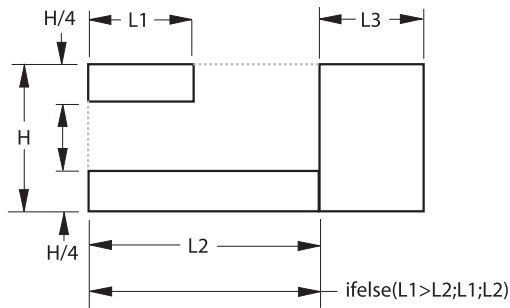
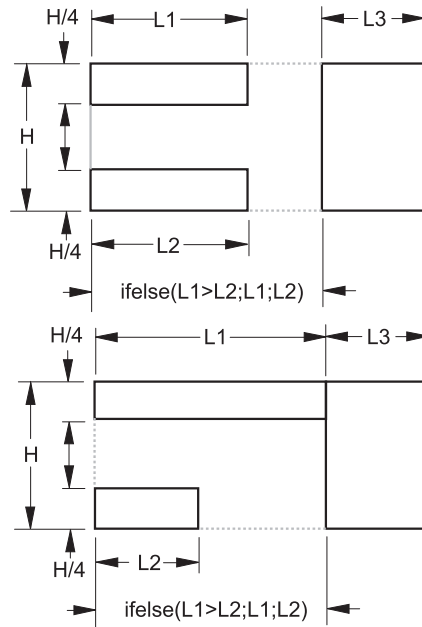
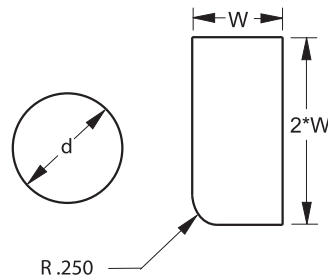

## Resolving the Parameters

Once the geometry is constructed and parametric dimensions are added, use the *Resolve* command to specify the values for the variables and redraw the geometry.

### **Resolve Command**

The *Resolve* command in the Edit menu redraws geometry automatically to fit specified dimensions. This parametric feature draws a geometric shape without regard to measurements and then Graphite redraws the same shape to the values specified.

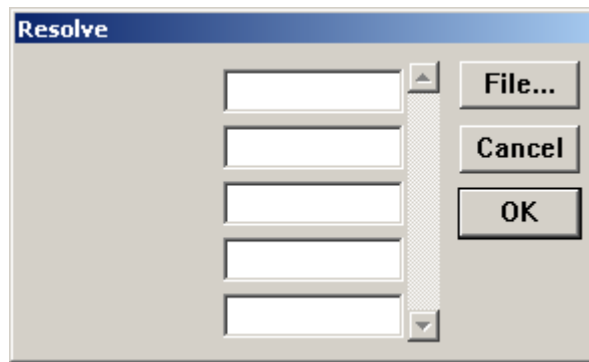

#### *Tech Note:*

Example: Use a mathematical expression with a fastener symbol. For a numbered fastener (#2, #4, #6, etc.) use the following formula for the thread size:  $(N*13+60)/1000$  where N is fastener number. For a #6 screw, the thread size equals  $6*13+60/1000$  or .138

### Using the Resolve Command with Parametrics

1. Create the geometry.
2. Dimension all geometry by using variables, constant values and expressions. (Dimension the essential, related geometry so Graphite can reconstruct the geometry. Graphite cannot identify parallel or colinear lines.)
  - Select the appropriate dimensioning tool.
  - Click the geometry to be dimensioned.
  - Enter an expression (such as **1.5, x, x+3\*y**) in the text data field in the Status Line.
  - Press the ENTER (Windows) or the RETURN (Macintosh) key.
3. Select the geometry and dimensions to be resolved.
4. Choose **Edit>Resolve**.
5. If necessary, enter the values to assign to the variables.

Enter mathematical expressions, fractions, and decimals in the data fields of the



**Resolve** dialog box. A mix of different units may be used as long as they are specific, for example 2'6".

6. Optional step: to anchor a point on the geometry at a particular location, click the point. The point remains in the same location after resolving the geometry. An example appears later in this section.
7. Click OK.

If the parametric dimensions defined the geometry properly, the geometry redraws as specified. The dimensions remain as variable expressions.

If Graphite cannot resolve the parametrics, a message box displays information about the problem. The "Parametric Problems" section, later in this chapter, describes typical problems that may be encountered. If all of the dimensions required to draw the geometry are not provided, the geometry divides into unrelated groups. The missing information determines how the groups relate to one another.

An alert box shows how many groups exist. To see each group, click Next. Examine the groups shown to determine why the position of each group is not related to any other. A group consisting of a single point is particularly telling. (This investigation can require some clever thought because the solution may not be obvious.)

The *Resolve* command cannot resolve ellipses and splines, unless the ellipse or spline is contained in a group. See the section on Parametrics and Grouped Objects.

## Specifying Parametric Variables in a Text File

When using parametrics which contain many variables, create a text file to specify the variables and avoid entering them in the Resolve dialog box each time the parametrics are resolved.

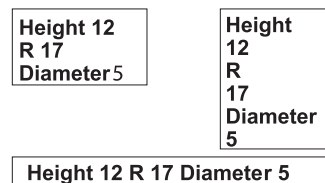

Create a text file which alternates the variables and the values, using white space (SPACEBAR, TAB, or ENTER (Windows), RETURN (Macintosh)) between entries. Graphite assumes the first entry is a variable and the second is the value for that variable. The text file might look like the examples shown here or any other arrangements).

### *Tech Note:*

To use a spreadsheet like *Microsoft Excel* for creating the text file, type in each cell the variable name and the value separated by a white space and export it as a text file.

### *Tech Note:*

If text file contains more variables and values than it is necessary to resolve the geometry, Graphite automatically imports only the needed variables and values.

### Using a Text File for Parametric Variables

1. Create the text file using any word processor or spreadsheet and saving it as *Text only*.
2. In Graphite select the geometry and parametric dimensions.
3. Choose **Edit>Resolve**.  
The Resolve dialog box displays.

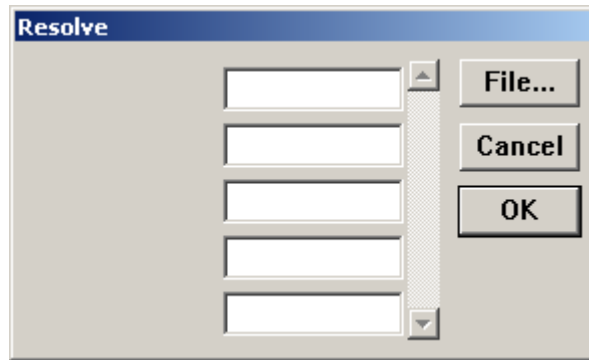

4. Click File to specify the values for the variables automatically.
5. Select the text filename.  
The variables and values are read from the file.
6. Specify an anchor point, if necessary.
7. Click OK.  
The geometry resolves accordingly.

### Anchoring the Geometry

Anchor the geometry by clicking the anchor point when the Resolve dialog box appears. For example, in a tutorial exercise in the *Getting Started* manual, parametrics were used to create the side view.

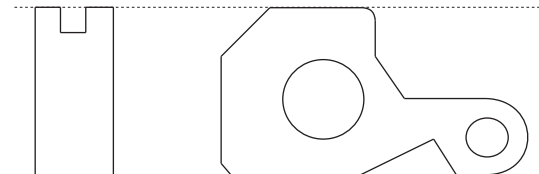

Using this side view as parametric geometry, it is possible to anchor the upper-right corner so that it remains aligned with the front view after resolution.

## Changing the Dimensions to Actual Measurements

Once parametric geometry is resolved, the dimension notations continue to show variables and constants. To make the geometry reflect the actual measurements, edit the dimensions. Follow these steps to change a resolved parametric dimension to a real value:

1. Choose **Edit>Selection Mask**.
2. Highlight the four dimension types in the box on the left.  
Only dimensions are selectable.
3. Choose **Edit>Select All**.  
All dimensions are selected.
4. Choose **Edit>Edit Objects**.
5. Change the entry in the text data field to a # symbol.
6. Click Apply.
7. Close the Edit Objects and Selection Mask dialog boxes.
8. Click the **Selection** tool to cancel the effect of the Selection Mask.

If different types of dimensions need to be in different formats, select each type separately.

## Parametric Drafting

This section describes how to modify standard drafting practices to accommodate parametrics. It describes three examples with three topics to illustrate how to define parametric geometry completely.

### Reminder:

- Define the geometry completely.
- Dimension all geometry.
- Relate all geometry.
- Do not include extraneous text.
- Return to the original part between tests.

## Dimension All Geometry

Center lines require consideration if they are to be resolved properly.

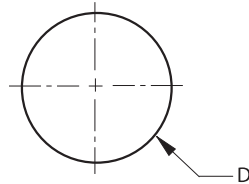

### Problem

Creating the circle shown with two centerlines, parametrics can resolve the circle but not the centerlines because the *endpoints* of the lines are not defined.

### Solutions

#### A. Using the Pen Style, Center

Looking at this problem as a connect-the-dots problem, notice that the centerlines have no dots to define them.

1. It is possible to construct the centerlines so their endpoints are *on* the circle, as shown here.
2. Include dimensions for the centerlines. The dimensions should be variables based on the diameter of the circle so when the diameter of the circle is specified, the centerlines are drawn relative to the diameter.

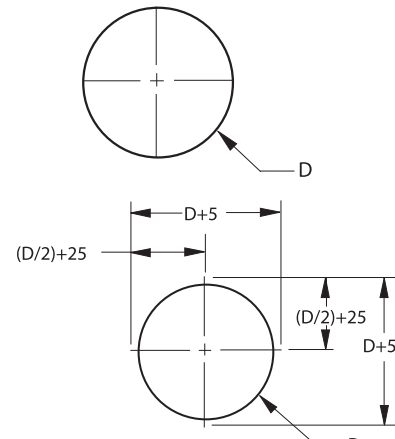

#### B. Using the Circle Center Line Tool

1. Use the **Circle Center Line** tool to place the center line on the circle.
2. Dimension the diameter of the circle and one of the center lines relative to the diameter. Dimension the center line from endpoint to endpoint or from the center of the circle to one endpoint of a center line.

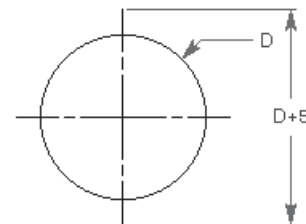

## Relate All Geometry

All parts of the geometry must be related.

### Problem

Both squares could be drawn by the parametric mechanism, but there is no way to determine their relative positions.

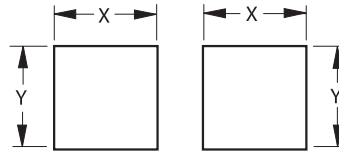

### Solution

Add a *constraint* line and dimension between the squares to connect the dots.

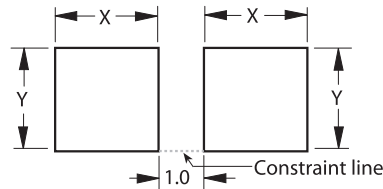

### Additional Tips:

1. The added dimension is an example of using a constant value. A variable expression such as  $x+y$  can be entered for the constraint line.
2. Constraint lines are ordinary lines usually drawn with the **Single Line** tool. They can be any line style, but they should be different from the lines of the regular geometry. The Construction line style is a good choice.
3. Placing the constraint line and dimension on a layer (named Constraints), that layer can be hidden when plotting the drawing.

## No Extraneous Text

Dimension all geometry because the parametric mechanism does not understand text and cannot detect symmetry.

### Problem

By dimensioning the radius of a filleted corner of a rectangle as *R .25 4 PLCS* to indicate four fillets, the parametric mechanism doesn't understand 4 PLCS and doesn't know the corners are symmetrical.

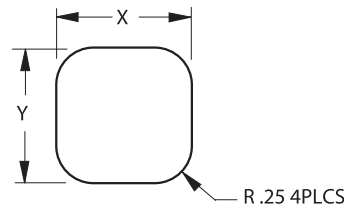

### Solution

Dimension each fillet.

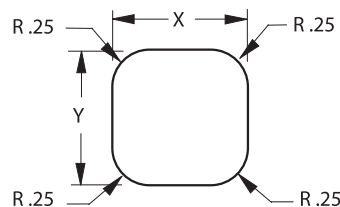

## Return to the Original Part between Tests

Resolving parametric geometry more than one time, unintentional constraints may be introduced that prevent the parametric function from returning to the original display of the part. Take the part below, for example.

### Problem

Resolving this geometry by specifying that  $R$  is half the measurement of  $X$  ( $R=X/2$ ), the resolved geometry would appear as shown in the lower illustration.

Resolve this geometry only with the same  $X$  value of  $R * 2$  because the undimensioned line is vertical, and according to the basic rules, vertical lines remain vertical.

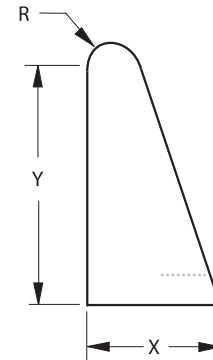
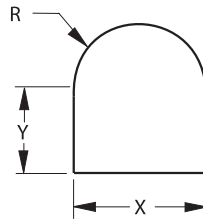

If a value for  $R$  or  $X$  is used other than the  $R = X/2$  relationship, the parametric mechanism would display this problem message:

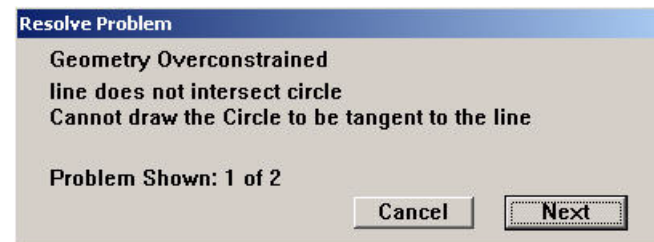

### Solution

Use the *Undo* command to return to the original shape. It is also possible to solve this problem by changing the geometry.

## Parametric Problems

This section illustrates problems that can be encountered when resolving parametric geometry. It provides examples and shows what caused the problem and how to solve it.

When resolving parametric geometry, problems which prevent resolution appear in a message box, stating the type and number of instances of the problems.

When a message appears, the problematic geometry appears as thick lines and individual dots. The lines indicate the geometry that the parametric mechanism can draw. Dots indicate unknown points. Click Next, and the next problem is shown. Examining of the relationships between the problems helps discern what must be done.

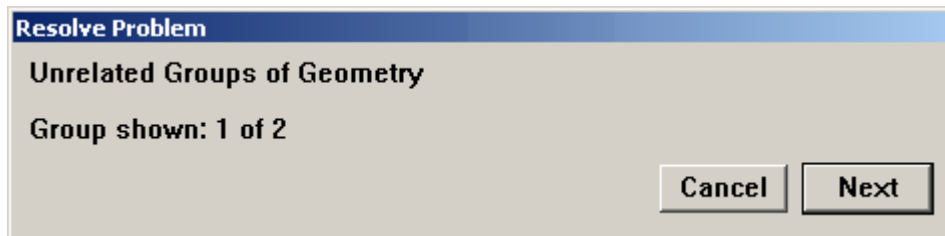
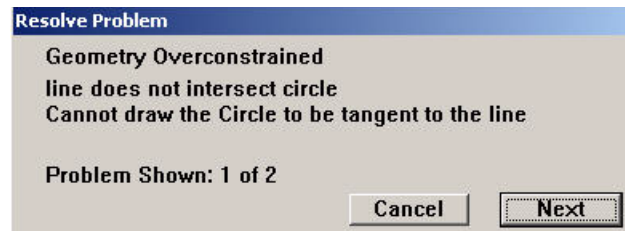

**Important:** Pay attention to single points. Remember, the parametric mechanism connects the dots. Frequently, one constraint or dimension can solve several problems at once.

### Geometry Overconstrained

The basic rules say that all geometry must be defined and every object must be related to some other geometry within the parametric definition. When geometry is overconstrained, it is related in more than one way, so the geometry's specifications could be resolved to more than one answer.

**Problem**

The diameters of the circles indicate the relationship between the circles adequately because the centerline remains horizontal and the circles are tangent to each other. The length variable causes the problem because the length between the centers of the circles may not correspond to the sizes of the connected circles. The centerline begins and ends at the centers of the circles.

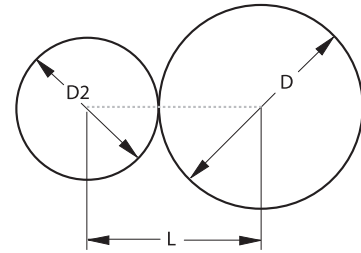

**Solution**

Delete the Length dimension.

**Unrelated Groups**

If not enough dimensions are provided, the parametric mechanism finds two or more groups of geometry, each of which is well-defined in itself, but not related to each other.

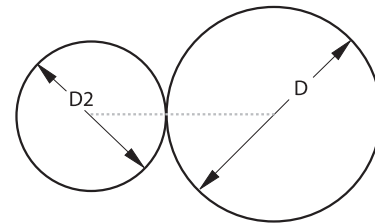

**Problem**

A simple example of this problem is illustrated on the left, where the short vertical line is not related to the rest of the geometry. Resolving this geometry, an *Unrelated Group Problem* message appears.

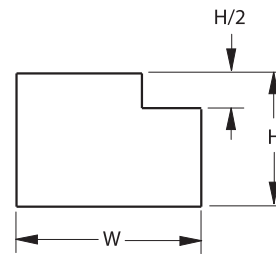

The first unrelated group appears in bold black lines. Click Next to highlight the second group.

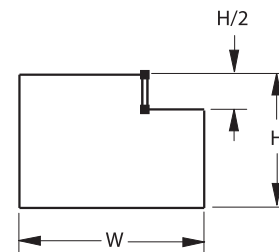
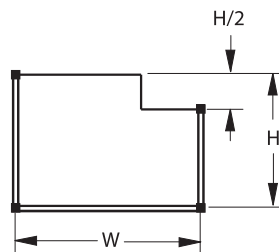



This problem is like the two squares shown earlier. Only one group could be drawn. The parametric mechanism does not know how to relate the two groups.

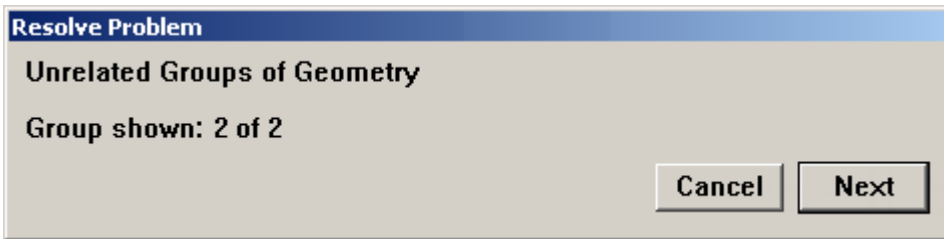
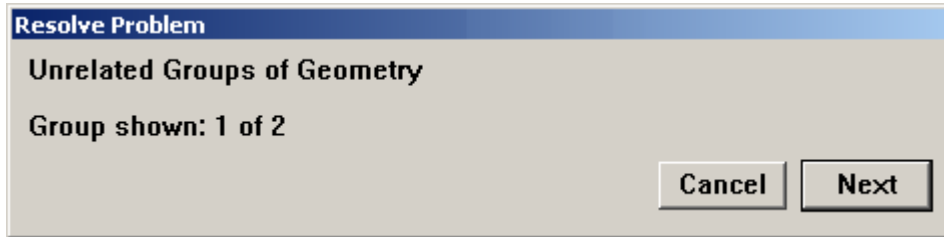

### **Solution**

Decide how to relate the groups. Usually, there are many options to accomplish this. For this example, adding the dimension  $W/3$  is one alternative.

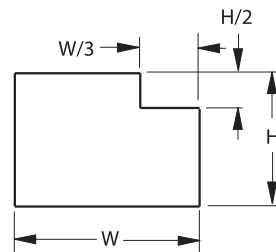

## Unrelated Groups where One Group is a Single Point

A single point as an unrelated group is like a neon sign saying: *The problem is right here!*

### Problem

The *Resolve Problem* message may display a single point, such as the point on the left hole of this example. That point is the *endpoint* of the circle.

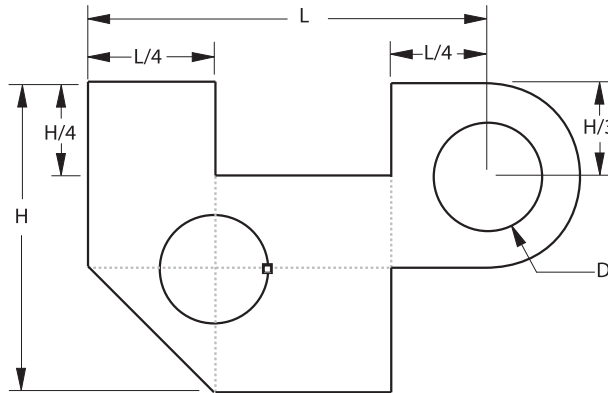

### Solution

On closer examination, it is seen that the circle is not dimensioned. Therefore, the solution is to dimension the circle.

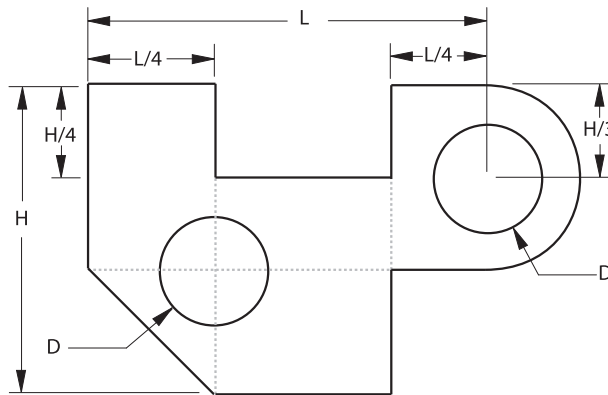

## Another Unrelated Group

### Problem

In this graphic, the height of the right side of the part is dimensioned. Assume that the height dimension applies to the right and left side. The parametric mechanism does not make that assumption.

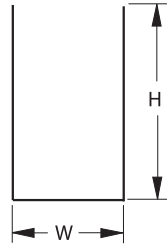

### Solutions

There are three possible solutions to this problem:

1. The height can be dimensioned on the left.

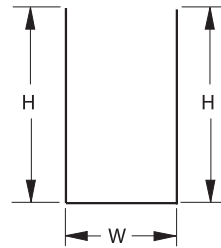

2. Draw a constraint line to close the opening.

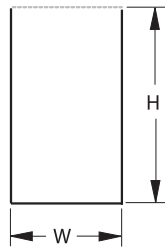

3. Dimension the height from the top of the left line to the bottom of the right line. While this is not good drafting practice, it is very useful for parametric symbols.

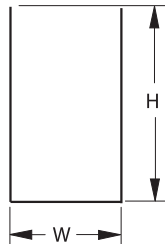

## Assumptions Involving Tangency

The parametric mechanism can identify tangent points but not the tangency of geometry.

### Problem

The *endpoints* of the lower line that is *tangent* to and ends at the circle can be determined. The upper line, however, is tangent to and extends beyond the circle and cannot be defined without more information.

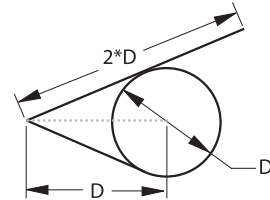

### Solutions

Here are three possible solutions to the problem:

1. Draw a constraint line from the *center* of the circle to the point of tangency for the line that extends beyond the circle, as shown here.

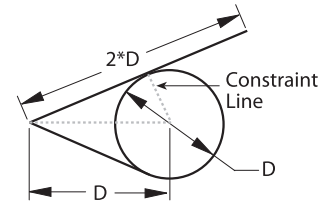

2. Use the **Rotate** tool on the **Transformation** subpalette to move the *endpoint* of the circle to the *tangent* point of the line that extends beyond the circle.

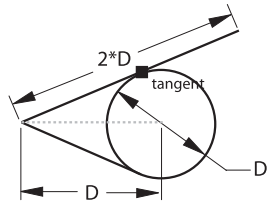

3. Divide the line into two segments which join at the *tangent* point.

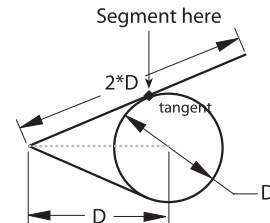

## Relationships Involving Symmetry

Create geometry with a mirrored copy, the parametric mechanism cannot resolve and maintain the symmetry without more information.

### Problem

The problem message shows three unrelated *groups*: the trapezoid on the left and the two rightmost corners, as shown below.

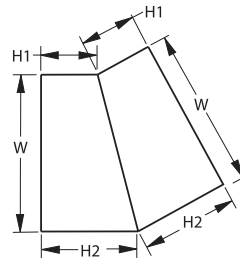

### Resolve Problem

#### Unrelated Groups of Geometry

Group shown: 1 of 3

Cancel

Next

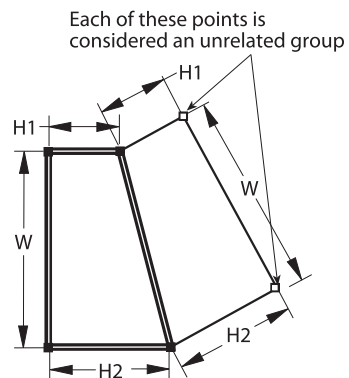

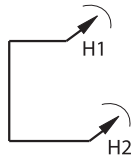

If parametrics swings an arc of the radius  $H1$  and  $H2$ , it doesn't know where the point is supposed to be on the arc. The point has a distance but no direction unless an angle dimension is added.

### **Solution**

Single points that are considered a group provide a clue to the solution. In this example, the parametric mechanism does not know where those points are, relative to the original trapezoid. Solve the problem by adding a constraint line and angle dimension between that line and the mirror line.

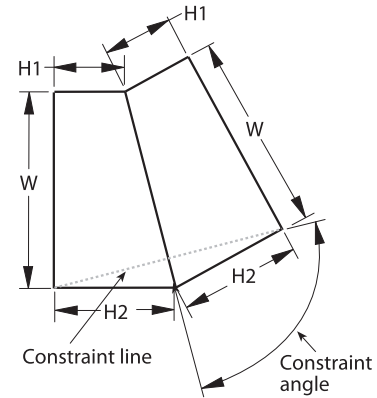

## **Complex Parametric Drafting**

This section illustrates two complex examples of parametric drafting. These examples combine the information provided in this chapter to display how to use the parametric mechanism.

### **Example—Departures from Standard Drafting**

This example illustrates the parametric drafting practices that differ from standard drafting practices. The first illustration is the side view of an adapter without dimensions so its shape can be seen clearly.

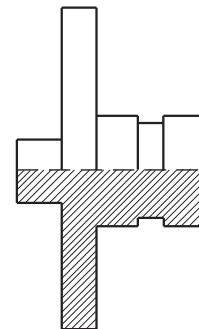

Here is the side view with typical dimensions added.

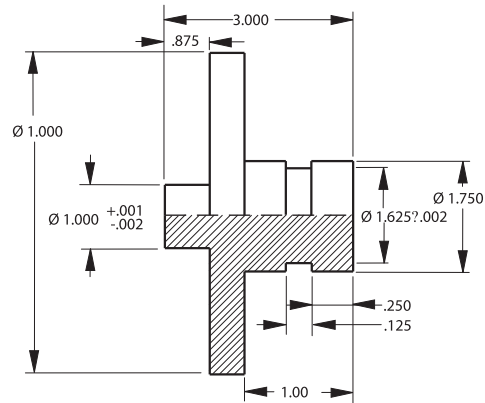

The illustration shows the side view with added constraint lines.

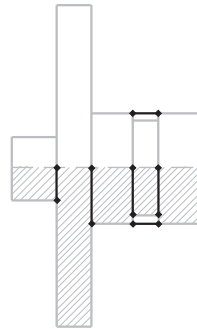

The next illustration shows the side view with numbered constraint lines.

1. The centerline does not extend beyond the geometry.
2. Constraint lines define the edges of the groove. Parametrics do not recognize non-touching colinear lines.

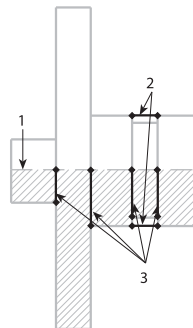

3. Constraint lines connect the *endpoints* of the upper and lower halves to relate the geometry. Parametrics do not recognize non-touching colinear lines.
4. Four dimensions are added to relate the geometry to the centerline. Parametrics don't recognize non-touching colinear lines.

The illustration below shows the completed parametric drawing.

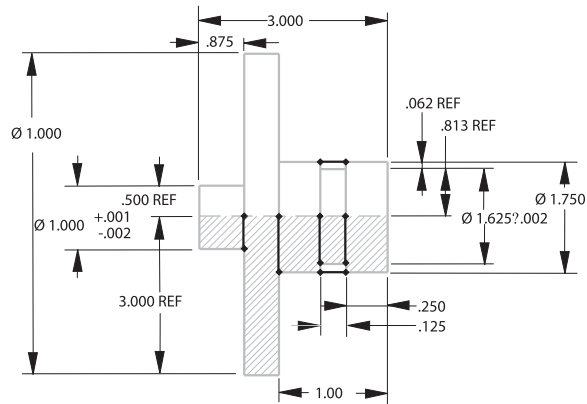
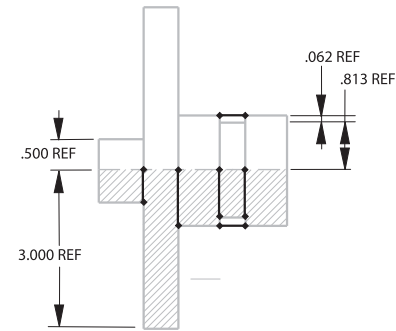

**Additional Tips:**

1. Place the additional information on a separate layer to hide the layer when plotting the drawing.
2. Using a yellow pen (which is hard to see against a white background) prevents confusing the additions with the actual geometry.



## Example—Keep It Simple or Testing as You Go

When there are unconnected multiple views, the parametric mechanism can't determine the relationships between them.

The coin chute example below describes the parametric drafting of three views.

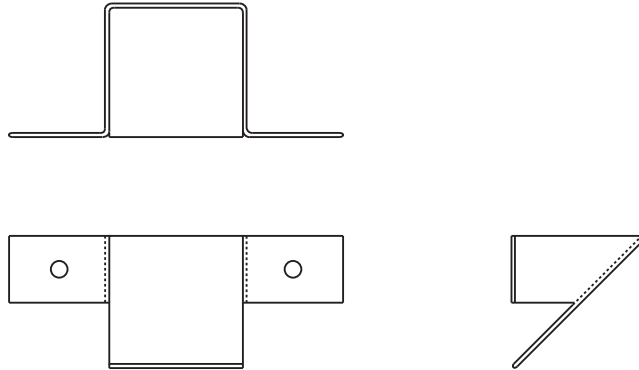

Dimension these views according to standard drafting practice, as shown.

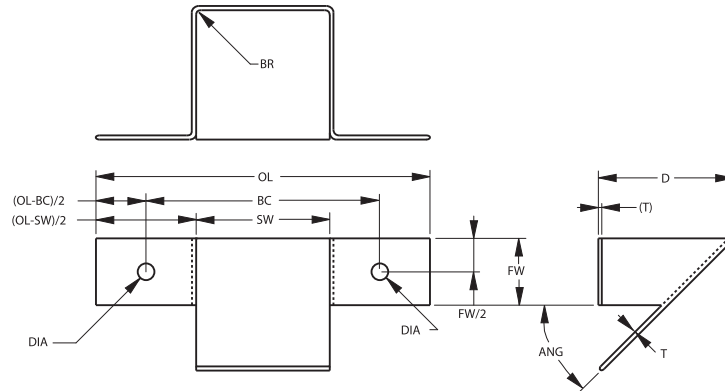

**Section 1**

1. Construct and resolve one section at a time. Solve any problems with this bracket before moving on.

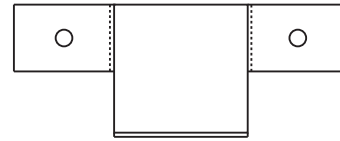

2. Add a centerline between the holes to maintain alignment.
3. Add a line connecting the lower edges of the flanges to keep the lines colinear.

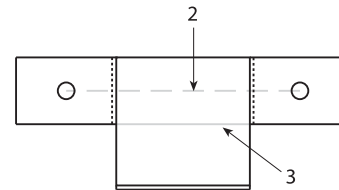

If the section below resolves without problems, go on to the next section.

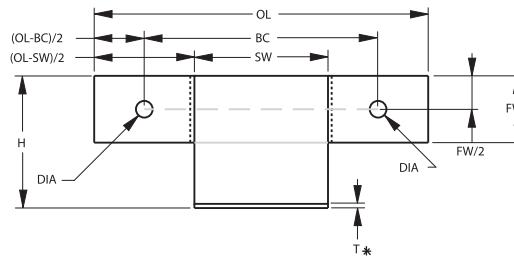

Once this view resolves properly, add the side view.

Since the side view determines height, delete the height (H) dimension and the lower thickness (T) dimension after adding the side view.

## Section 2

1. Add constraint lines to connect the geometry between sections.
2. Add a dimension to specify the distance between the sections. (See the two box problem earlier in this section.)

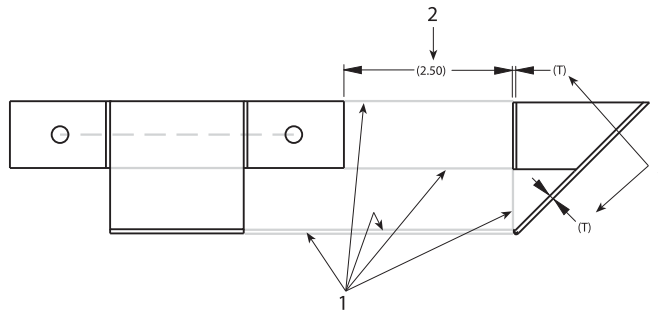
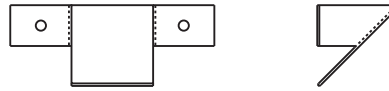

3. Add extra thickness (T) dimensions since all geometry must be defined.

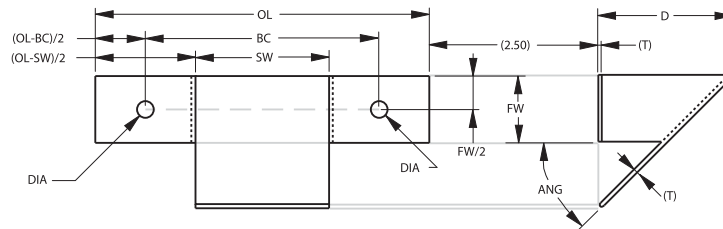

## Section 3

1. Dimension each fillet, as explained earlier.

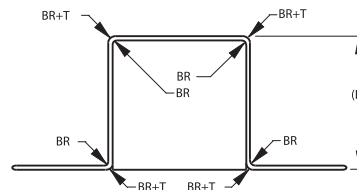

2. Relate this section to the rest of the geometry.
3. Add a dimension to specify the distance between the sections.

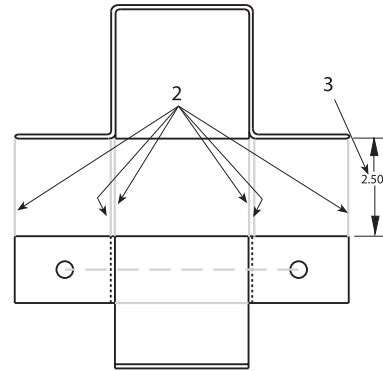

Three sections are related as shown below.

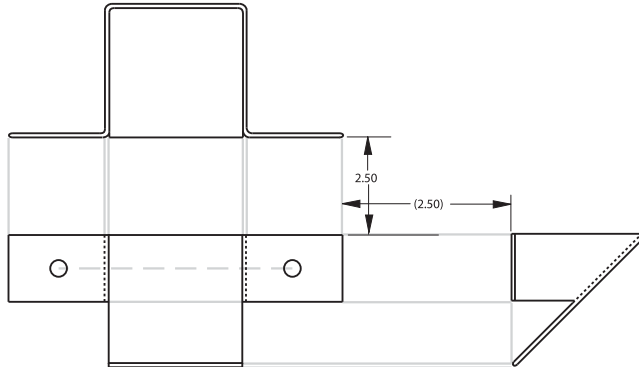

This is the completed parametric drawing.

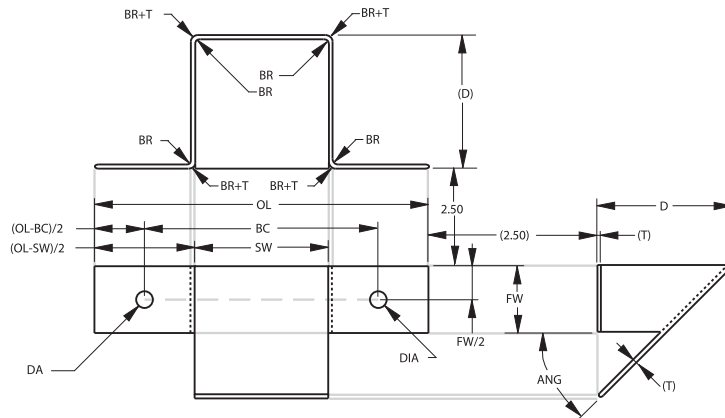

## Parametrics and Grouped Objects

It is possible to create many objects. Group them and then treat them as a single parameterized object. There must be a framework on which the group sits. Dimension between two control points on the framework and then resolve the framework. The group changes accordingly, shrinking or expanding proportionately to the distance between the control points.

Create a spline and group it.

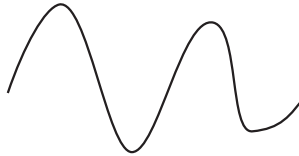

Then create a framework line between the *endpoints* and dimension the line.

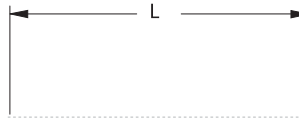

When resolving for the length of the line (L), the spline changes accordingly.

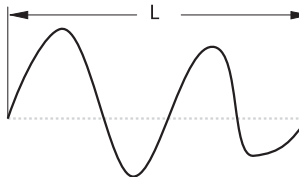

### Using Parametrics and Grouped Geometry

1. Create the geometry to be parameterized.
2. Select the geometry.
3. Choose **Arrange>Group**.
4. Create a framework on which the grouped geometry sits.
5. Dimension between two control points. It is possible to use only one variable per group.
6. Select the framework, the dimension and the group.
7. Choose **Edit>Resolve**.
8. Enter the value for the distance between the control points.
9. Click OK.

Including a dimension as part of the Group, the dimension changes when the Group is resolved. It is not used as part of the parametric solver.

## Rigid Links

Geometry can be grouped into a rigid body and then attached to the rigid body to parametric geometry in at least two points. Resolving the parametric geometry, the rigid body undergoes the same geometric transformation.

The following shows an example of using parametrics with grouped objects. Begin with a basic shape that resolves properly, as shown in the part below. Then add the thread groups. By resolving the part, the threads also resolve.

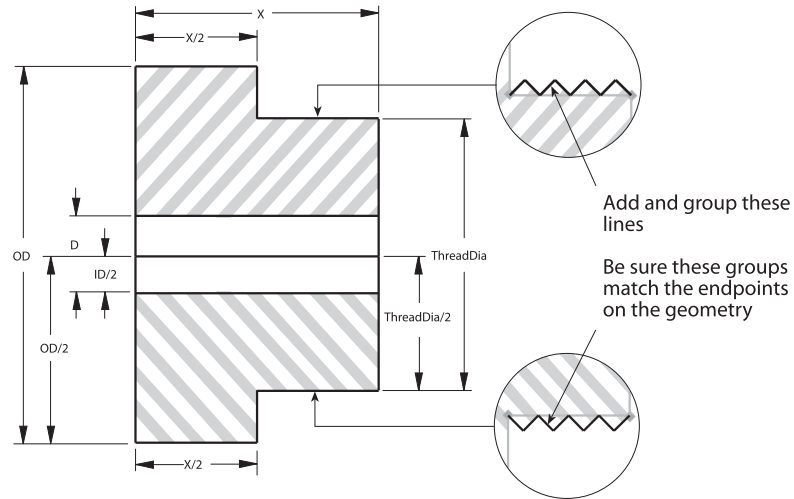

The next example shows, the usual method of parametric drafting followed by an example of how using parametrics with groups simplifies changes to the part.

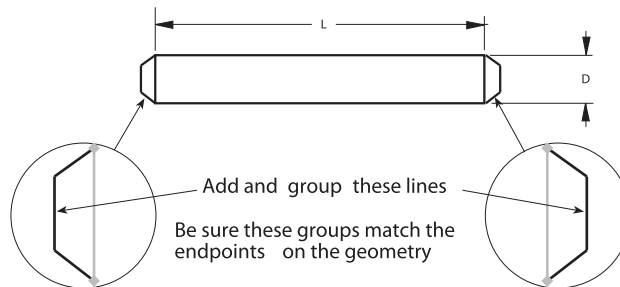
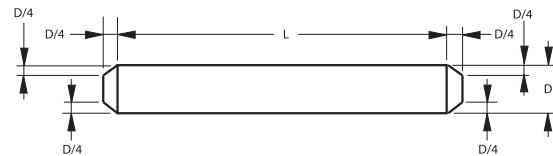

## Parametrics in 3D

The parametric feature works in 3D with some restrictions. Consider its functionality as 2 1/2D since it functions properly in all planes parallel to the work plane.

The parametric mechanism has two phases. In the first phase, the parametrics ignore the z coordinates of the selected geometry and resolve the geometry as it does in 2D. Any dimension that is not completely in a plane parallel to the x,y plane is also ignored. In other words, the x and y coordinates are resolved and the z coordinates are not changed.

In the second phase, parametrics adjust the z coordinates, as necessary. All linear dimensions parallel to the z axis are examined and every point in the selected geometry is considered to define a plane parallel to the x,y plane. The dimensions in the z direction define the required distances between these planes. Unlike the first phase, in the second phase parametrics are very tolerant of missing dimensions. If the dimensions do not completely define the distance between any two planes, then the distance is not changed.

In phase two, any line or arc that does not lie in a plane parallel to the x,y plane is modified appropriately because the defining points are adjusted by the parametrics and the line or arc is changed accordingly. This includes all lines parallel to the z axis and any oblique lines at any angle to all three axes.

Parametrics deal with all geometry in the current work plane coordinates. Consequently, it is a good idea to set up a view that looks down the z axis of the work plane onto the x,y plane. In this way, it is possible to see what the first phase of the operation “sees.” This is particularly useful to encounter problems resolving parametric geometry. Errors in parametrics are shown in bold lines drawn in the x,y plane and independent of the z values of the highlighted lines. The easiest way to see this is to look down on the x,y plane by choosing **Views>View The Plane**.

In the drawing below, the first phase of parametrics will deal with only four dimensions  $W$ ,  $L$ ,  $L/2$  and  $L/4$ . In the second phase, the  $H$  and  $H/3$  dimensions are evaluated.

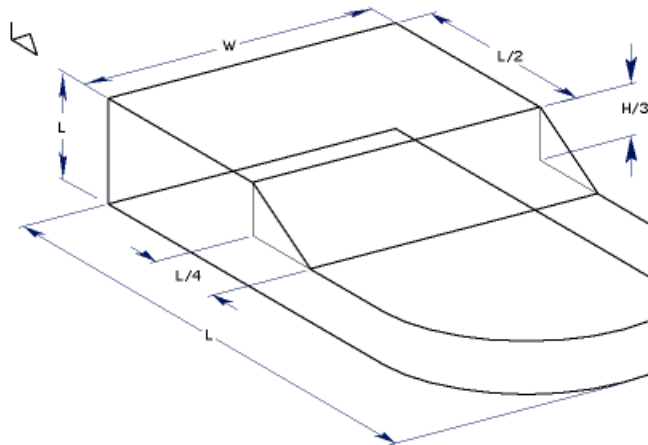
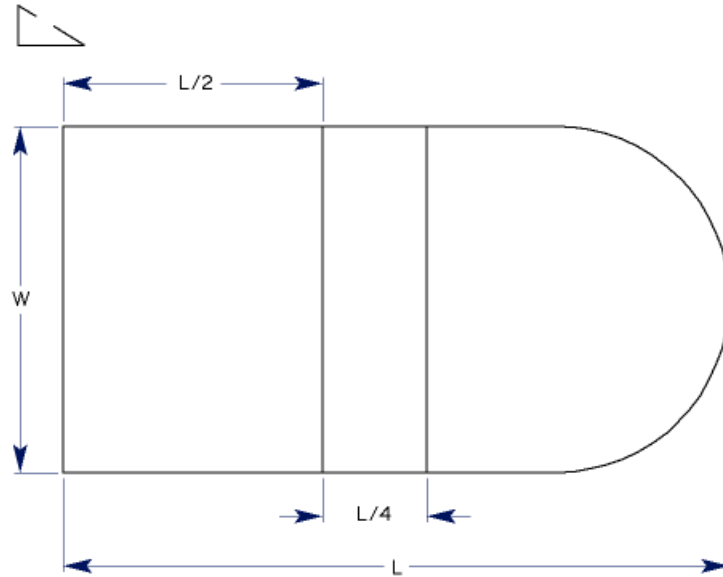



# Symbols

In Graphite it is possible to place any drawing as a symbol and open any symbol as a drawing. Create symbol documents for generic, parameterized parts, and then bring them into the drawing, customizing the dimensions with each use. Symbols are particularly useful for creating a library of standard designs common to your work. For example, create libraries of windows, screws, nuts or bolts.

Graphite distinguishes between:

- *Simple symbols*, which have neither parametric dimensions nor underlying value tables
- *Parametric symbols*, with editable dimensions
- *Symbol libraries*, that contain parametric symbols with underlying value tables.

All commands used to manipulate symbols are found by choosing **File>Symbols....**

Most of the symbols shipped with Graphite are parametric symbols. Parametric means that the symbol's final measurements can be specified just before placing them into a drawing. This feature uses one symbol in countless variations.

The following topics are covered in this chapter:

- Using Symbols
- Placing Symbols
- Smart Symbols
- Symbol Libraries
- Creating Symbol Libraries

## ***Using Symbols***

The installation procedure copied the parameterized symbols in to the Symbols folder of the Graphite folder. Look at some of those symbols to get an idea of the type of symbols to be created with Graphite.

When a symbol is brought into a drawing, it is necessary to indicate its location and orientation. In order for this to work properly, a control point must be at the Origin (0,0) in the original symbol file.

As a special feature for use with parametrics, lines in the Construction pen style do not appear with the symbol when it comes into a document. Use this feature to define your own smart windows and smart doors, as well as other symbols.

### **Creating a Symbol Document**

1. Construct the geometry, using the Construction pen style for any lines that should not appear in the symbol when it comes into a drawing. Be sure to place one control point at (0,0) to specify the location of the symbol when bringing it into a drawing.
2. Dimension all aspects of the part by entering a variable in the text data field in the status line of each dimension.
3. Choose ***Edit>Resolve*** to check the accuracy of the parametric dimensions.
4. Choose ***File>Save As***.
5. Name the document.

## Placing Symbols

It is a very easy process to place symbols into the drawing. Using **File>Symbol...**, place either newly created symbols or those that came with the program.

### Symbol Commands

When selecting *Symbol* in the File menu, an open file dialog box appears. Use the dialog box to navigate and select a symbol directory. All the symbols in that directory are loaded into the *Symbol Panel* and their file names display along the left side of the *Symbol Panel*.

### Insert

Choose **File>Symbol...** and a standard open file dialog box displays. Once a symbol is selected, the *Symbol Panel* appears.

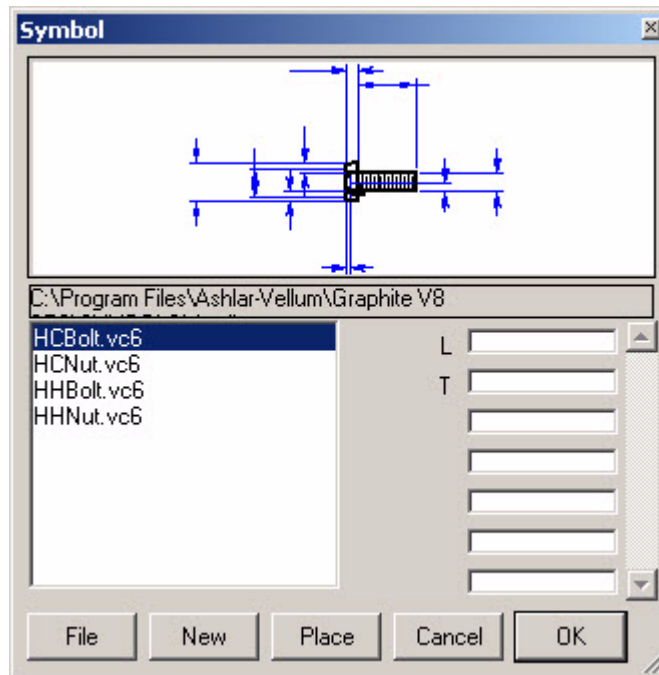

The dialog box displays a preview of the symbol and lists the file names of all other symbols stored in that directory. The *Symbol Panel* is resizable.

For parametric symbols, entry fields for all variables defining the symbol are displayed.

#### Tech Note:

Click the small resize box in the lower right corner of the *Symbol Panel* to drag and resize the symbol. Shift click to minimize the panel (for use on nonparametric symbols, such as nuts, bolts, valves, etc.)

To place the symbol in the drawing, click or drag a vector on the drawing area. Click and the symbol inserts at the clicked location, in its original orientation. Drag and the starting point of the drag specifies the *insertion point* for the symbol and the direction of the drag indicates the *orientation*.

### Bringing a Symbol into the Current Document

1. Choose **File>Symbol....**

The Open dialog box appears.

2. Select the symbol file to be used and click Open.

The Symbol dialog box appears displaying a preview of the currently selected symbol. All symbol files in that directory appear in the symbols list on the left side of the *Symbol Panel*.

3. Enter a value for each of the parametric dimensions.
4. Specify the location and orientation for the symbol.

In the dialog box, a triangle appears on the geometry to indicate the origin or the point being located. Click, the symbol inserts at the clicked location, in its original orientation.

Drag and the starting point of the drag specifies the insertion point for the symbol and the direction of the drag indicates the orientation.

If a location is not specified, scroll as necessary to see the symbol.

5. Click OK.

The geometry resolves and appears in the current drawing at the location clicked, sized as specified.

The symbol geometry is selected so it can be moved to a new location.

6. Add regular dimensions if desired.

To see an enlargement of any part of the symbol within the viewing window, move the pointer to the area of interest and press the mouse button. The enlargement reduces when the mouse button is released.

#### *Tech Note:*

Use a text file to fill in parametric dimensions of a symbol. Create a text file with value pairings for each variable and its value. Then load the symbol and *click* on File in the *Symbol Panel*. The file automatically fills in the values specified for each dimension.

### Browsing a Directory of Symbols

1. Choose **File>Symbol...**

The Open dialog box appears.

2. Select a symbol file from the directory to be browsed and click Open.

The Symbol dialog box appears displaying a preview of the currently selected symbol. All symbol files in that directory appear in the symbols list on the left side of the *Symbol Panel*. (To change the selected symbol, *click* on a file name from the list along the left side of the *Symbol Panel*. The preview pane updates to display the currently selected symbol.)

3. Click New to load a different directory of symbols.

### Importing a Symbol

Use the *Import* command from the File menu to bring in the geometry and dimensions of a symbol. When importing a symbol, it comes into the current drawing at the size it was drawn. Specify new measurements by choosing **Edit>Edit Objects** or choose **Edit>Select All** and then choose **Edit>Resolve** to change the size.

### Editing Parametric Symbols

Using the *Edit Objects* command it is possible to edit parametric symbols placed in a drawing. After selecting the symbol, choose **Edit>Edit Objects**, then edit the dimension of the symbol.

## Smart Symbols

The Architect folder of the Symbols folder contains smart symbols for doors and windows. Smart window and door symbols are smart because they contain a smart wall segment. Adding one of these symbols to a smart wall breaks it into the wall in the specified location.

When creating custom smart symbols, draw smart walls with the Construction pen style. (Geometry created with the Construction pen does not appear when it is brought into a drawing.) The invisible geometry is still functional in that existing smart walls in the drawing detect the invisible wall of the symbol.

Draw a thick wall in line with or overlapping a thinner wall, so it hides the thinner wall. Therefore, to get a symbol to mask part of a wall, include a single wall that overlays the target wall. To see an example, open one of the smart symbols in the Architect folder that was installed with Graphite.

### Creating a Smart Symbol

1. Choose **Pen>Style>Construction**.
2. Draw a smart wall thicker than the maximum thickness expected to be used and only as long as the final symbol is.
3. Change pen styles to any style other than Construction.
4. Draw the symbol.
5. Choose **File>Save As** and save as usual.

### Using Symbols for Smart Windows and Doors

The Symbols/Architect folder that was installed with Graphite contains symbols for smart windows and smart doors. These symbols work like regular Graphite symbols in that they are parameterized and can be placed and oriented on a drawing. In addition, they break into any smart wall they touch and the cut area of the smart wall fills in if the smart symbols are moved or deleted.

## 2D Analysis

The 2D Analysis provides sectional properties for the selected geometry, a feature that is useful for many calculations related to design and drafting. Architects use the perimeter and area values for calculating material requirements; engineers use the moments of inertia for stress analysis; manufacturers use the centroid for balancing parts for turning. The following topics are covered in this section:

- 2D Analysis
- Calculations

## 2D Analysis Command

The *2D Analysis* command in the Layout menu displays the statistics on the selection, including the length of the perimeter, the enclosed area, the center of gravity (centroid), and moments of inertia. The selection must be a closed figure.

### Tech Note:

The closed figure is an area that could be crosshatched. If in doubt about the area, simply crosshatch the geometry to see if it represents the area that needs to be analyzed.

### Performing 2D Analysis

1. Select the geometry that defines a closed boundary. Use the **Tracer** tool to select the perimeter.
2. Choose **Layout>2D Analysis**.

The analysis is performed and the values appear in the dialog box.

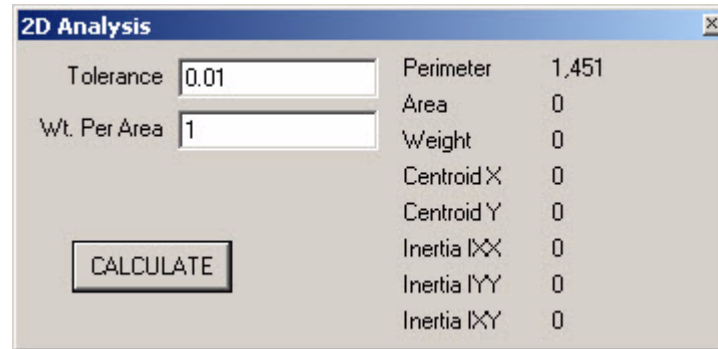

### Tech Note:

Once the area is crosshatched and the selection is correct, choose **Undo** to remove the crosshatching and still maintain the selection.

3. If necessary, enter changes for the tolerance and weight per area values.
4. Click **CALCULATE**.

The analysis recalculates and the new values appear in the dialog box.

The following items are included in the dialog box:

#### Tolerance

Determines the accuracy of calculations for curved objects. The smaller the tolerance, the higher the accuracy. The default value is 0.01. Change the value by entering a new number.

The 2D analysis mechanism analyzes arcs, circles, ellipses and splines as straight line segments that deviate from the true curve by no more than the stated tolerance value. The smaller the number, the greater the accuracy, however, the greater the accuracy, the longer the calculation time.

### Tech Note:

This tolerance value has no effect on the precision of the resultant values. The precision of the result is set by choosing **Layout>Preferences>Units**.



**Weight Per Area**

A multiplier used to determine the actual weight of a part of constant thickness defined by a selected boundary. The weight of the part is the product of the Area multiplied by the Weight Per Area.

The default entry is 1. Change the value by entering a new number. Find the proper number for this entry in a handbook published by most material vendors, particularly for sheet steel and aluminum. Enter the weight for the thickness of the proposed material and click CALCULATE.

For example, to analyze a square as if it were a cube three inches thick, enter **3 \* the material's density** in the weight per area box.

**Perimeter**

The length of all segments which define the selected boundary. This is the only value that appears if the boundary is not closed.

For circles, arcs and other curves, the accuracy depends on the tolerance setting.

**Area**

The surface area enclosed by the selected boundary.

For circles, arcs and other curves, the accuracy depends on the tolerance setting.

**Weight**

The product of the *Area* multiplied by the *Weight Per Area*.

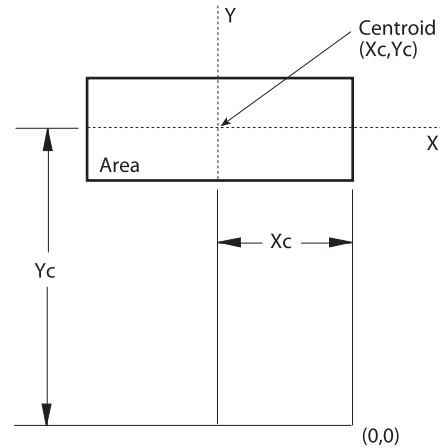
**Centroid X**

The X coordinate of the center of mass defined by the selected boundary.

**Centroid Y**

The Y coordinate of the center of mass defined by the selected boundary.

**Inertia IXX**

The moment of inertia about the central X-X axis which is parallel to the X-axis.

$$I_{XX} = \frac{1}{2}(y - Y_c)^2 dA$$

**Inertia IYY**

The moment of inertia about the central Y-Y axis which is parallel to the Y-axis.

$$I_{YY} = \frac{1}{2}(x - X_c)^2 dA$$

**Inertia IXY**

The product of inertia about the centroid.

$$I_{XY} = \frac{1}{2}(x - X_c)(y - Y_c)dA$$

## Calculations

Graphite calculates the values for 2D Analysis before the dialog box appears. To make a change in the *Tolerance* or the *Weight Per Area*, click CALCULATE to recalculate the statistics.

The 2D Analysis mechanism evaluates the boundary in the same way the crosshatching mechanism does. For example, Graphite considers a circle inside a bounded area to be a hole. Crosshatching does not fill the hole and 2D Analysis does not include the area of the circle in the area calculation.

### Displaying the Centroid

1. Select the geometry defining the part.
2. Choose **Layout>2D Analysis**.  
The 2D Analysis dialog box appears.
3. Choose **Layout>Construction**.  
The Construction dialog box appears.
4. In the *Angle* field in the Construction dialog box, enter **0;90**. (Be certain to separate the numbers with a semicolon.)
5. Enter the value for Centroid X in the *X* field of the Construction dialog box.
6. Enter the value for Centroid Y in the *Y* field of the Construction dialog box.
7. Press ENTER (Windows) or RETURN (Macintosh).  
Construction lines display, intersecting at the centroid of the selected part.



# Bill of Materials

Bill of Materials is an important extension to CAD programs for tracking and listing parts all the way through the product design and manufacturing process. In the product manufacturing industry every part produced has some type of distinguishing mark—typically the part number—either stamped, etched, embossed, or silk screened onto the part. The manufacturer also needs to document the design and track the characteristics of each part like material, cost of manufacturing, and outside vendor code during the product development process.

The following topics are covered:

- Introduction
- Attributes
- Item Numbers
- Bill of Materials Table

## Introduction

Graphite's Bill of Materials Extraction utility attaches characteristics (attributes) to the parts being designed. From these attributes, Bill of Materials table is extracted. This Bill of Materials table can be printed separately or with the drawing.

In addition, it is possible to export the Bill of Materials to other applications.

The Bill of Materials Extraction utility is completely integrated in Graphite and combines powerful functionality with an easy to use interface.

Generating a Bill of Materials is a two step process:

- Defining and assigning attributes to object geometry in drawings.
- Extracting user-defined and predefined attributes in the form of lists or ASCII-files for export purposes.

When using the Bill of Materials Extraction utility for the first time, start by interviewing all the groups within your organization to determine which characteristics need to be tracked. The next step is to assign these characteristics to an existing catalog of parts, typically Graphite symbol files. These parts can then be used to create an assembly or installation drawing. These attributes can then be extracted into a Bill of Materials table or exported for use in other applications.

The Bill of Material distinguishes between two kinds of attributes:

### User-defined Attributes

Define and assign attributes to object geometry after creating it.

### Predefined Attributes

These are numerical attributes like the perimeter or area of a circle which are automatically defined by creating the geometry.

Non-numerical attributes like line color and line style are not recognized by the Bill of Materials.

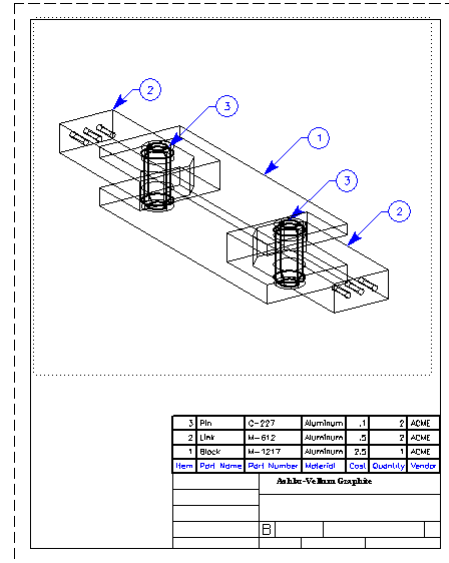

## Attributes and Objects

Each object created in Graphite automatically has different kinds of attributes: *numerical attributes* like the perimeter and the area of a circle, and *non-numerical attributes* like the line color and the line style.

With the Bill of Materials Extraction utility, assign User-defined Attributes to objects, like a Part Name or Part Number.

### Defining Attributes

Before assigning attributes to objects, they must first be defined. To define attributes choose **Text>Bill of Materials>Define Attributes**.

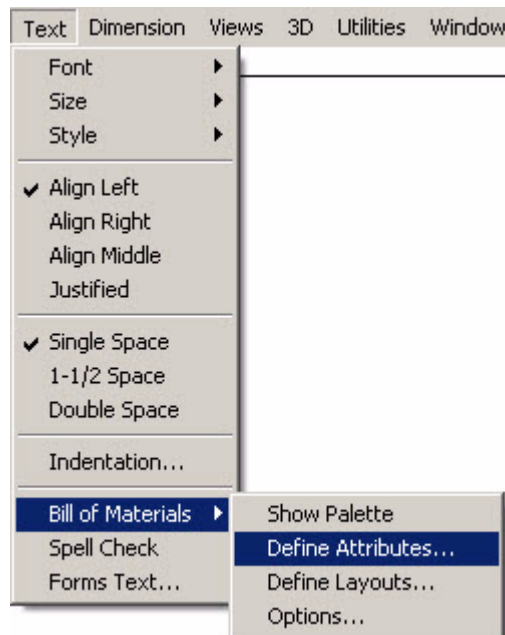

### Attributes Command

This command defines, deletes, redefines and activates attributes. Active attributes (attributes which can be assigned) are indicated by an eye icon in front of the attribute name. Locked attributes (their values cannot be changed during assignment) are indicated by a lock icon in front of the check mark.

The *Define Attributes* command displays the dialog box on the right.

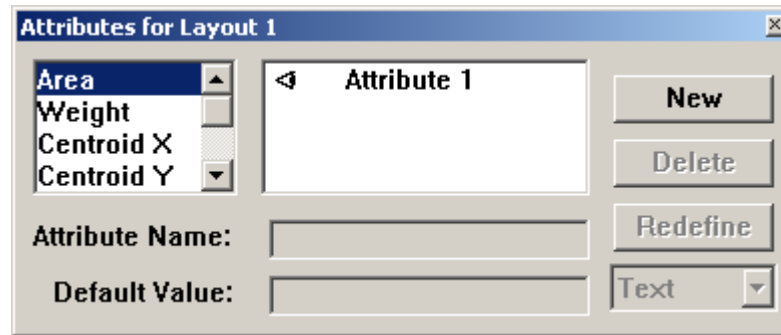

Attributes are defined in the Define Attributes dialog box by three parameters:

- |                                    |  |
|------------------------------------|--|
| <b>Attribute Name</b>              | Specifies a general name for the attribute like name, material, serial number, etc.  |
| <b>Default Value</b>               | Assigns a specific value to the attribute. For example, the value of steel can be assigned to the attribute of material. The value of an attribute can be changed in the Status Line before assigning it to object geometry or in the Edit Objects dialog box after it has been assigned.  |
| <b>Format (Text, Number, Qty.)</b> | Select a format for the attribute value in this pop-up menu. Choose between three attribute formats: <i>Text</i> , <i>Number</i> and <i>Qty</i> .<br><br><i>Text</i> is the default format and is the choice for all alpha-numeric values (Text entries) like Name, Material, etc.<br><br><i>Number</i> is the choice for all values which are expressed by numbers used for further calculations. A part number like <i>S3456</i> or <i>252-49</i> would be formatted as Text, since this value would never be used for any kind of calculation. To use hyphens or dashes in the Part Number, use the <i>Text</i> format, not <i>Number</i> . |



*Qty.* causes the Bill of Material to calculate the number of identical objects in a drawing.

The Define Attributes dialog box contains the following buttons:

<b>New</b>	Clicking New creates a new attribute like Attribute 1, 2, 3, etc. Rename the attribute by typing the name in the <i>Attribute Name</i> entry field and clicking Redefine.
<b>Delete</b>	Clicking Delete deletes the selected attribute from the attribute list.
<b>Redefine</b>	Clicking Redefine does three things: First, it renames a selected attribute with the name specified in the <i>Attribute Name</i> entry field; second, it assigns a value to the attribute which may be entered in the <i>Default Value</i> entry field; and third, it assigns the format for the attribute selected from the <i>Format</i> pop-up list.

### Defining Attributes

1. Click New to create a new attribute.

In the *Attribute Name* entry field Attribute 1 displays.

2. Rename the attribute by typing a name in the *Attribute Name* entry field, like COST.
3. Specify a value for the attribute in the *Default Value* entry field.  
The value can be changed in the Status Line during assignment, like 2.50. The format must be *Text*, not *Number* if the \$sign is used.
4. Select a format for the new attribute. In the examples given above, the format is *Number*.

Click the *Format* pop-up menu and select.

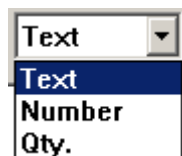

5. Click Redefine.

The new attribute name appears in the attributes list, and the specified value and format is assigned to the attribute.

6. Close the Define Attributes dialog box.

### Show or Hide Attributes

Only visible attributes (indicated by an eye icon beside the attribute name) are displayed during assignment. Hidden attributes cannot be edited.

1. Select an attribute to show or hide from the list box. The eye icon beside the attribute name indicates that an attribute is visible.

### Locking and Unlocking Attributes

To lock or unlock an attribute simply click in front of the attribute's name. The lock icon in front of the name appears or disappears.

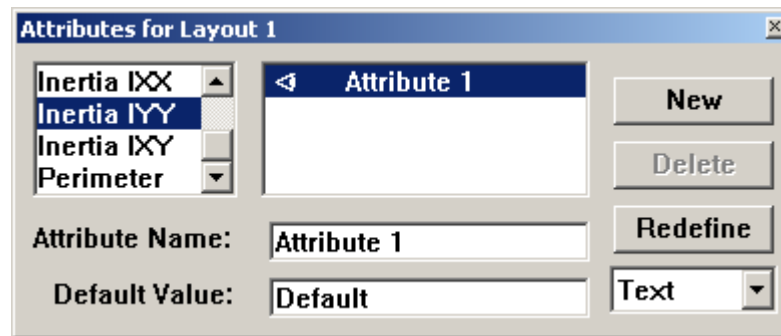

The values of locked attributes cannot be changed during assignment.

### Changing the Characteristics of an Attribute

Choose the **Text>Bill of Materials>Define Attributes** to open the Define Attributes dialog box.

1. Select the attribute whose name, value or format needs to be changed.
2. Type a new name or value, or choose a new attribute format.
3. Click Redefine.

The new attribute name appears in the attributes list and the new value and format are assigned to the attribute.

4. Close the Define Attributes dialog box by clicking Close.

### Deleting Defined Attributes

Choose **Text>Bill of Materials>Define Attributes** to open the Define Attributes dialog box.

1. Select the name of the attribute from the list box.
2. Click Delete. The selected attribute deletes.

## Saving Attributes

With the Redefine button, rename an attribute or assign a new value or format to the attribute.

To save all attribute definitions permanently, choose **Layout>Preferences>Save Preferences**. Close Graphite and relaunch it for the new preferences to take affect.

## Predefined Attributes (Graphite Attributes)

Predefined Attributes are attributes that Graphite defines. These attributes are calculated and displayed using 2D Analysis (see Chapter 18). Choose the ones from the list by double clicking.

- Perimeter
- Area
- Weight
- Centroid X
- Centroid Y
- Inertia IXX
- Inertia IYY
- Inertia IXY

For predefined attributes enter the attribute's name only, since their values and formats are predefined. These attributes are displayed in the Status Line but cannot be changed, since Graphite calculates the values automatically.

## Assigning Attributes

Assign attributes using the **BOM** tools. Activate **BOM** tools like any other tool in the Graphite tool palette.

An object's attributes are inaccessible if the object is grouped, so that the group itself can have attributes. The object's attributes are made accessible by ungrouping the group. Ungrouping a group with attributes removes the group's attributes.

## BOM Tools

Graphite's **BOM** tools are on a separate palette which can be dragged around the drawing area. The palette displays by choosing **Text>Bill of Materials>Show Palette**.

### Show Palette/Hide Palette

Choose **Text>Bill of Materials>Show Palette** or **Hide Palette**, to display or hide the BOM palette.

Remove the tool palette using the button at the top of the palette.

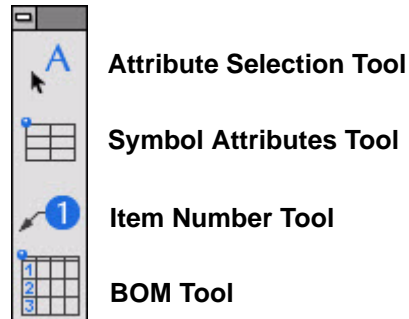

### Attribute Tools



With the attribute tools, assign attributes to object geometry or mark an object as a symbol. By selecting one of these tools all attributes of the current BOM layout display in the Status Line. Hidden attributes do not display in the Status Line.

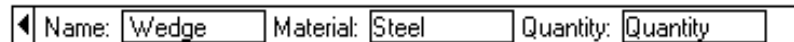

The attribute values shown in the Status Line can be entered or modified if they are not locked. If they are locked, the attribute's value is grayed out.

## Attribute Selection Tool



Assign attributes of the current layout to a selected object with this tool.

### Assigning Attributes

1. Choose **Text>Bill of Materials>Define Layouts**.

The Define Layouts dialog box displays.

For more information about the Define Layouts dialog box, see the “Bill of Materials Layouts” section later in this chapter.

2. Select a BOM Layout.
3. Close the Define Layouts dialog box by clicking Close.
4. Select **Text>Bill of Materials>Define Attributes**.  
The Define Attribute dialog box displays.
5. Hide all attributes which needn't be assigned to object geometry in the current drawing by deselecting the eye icon next to that attribute.
6. Close the Define Attributes dialog box.
7. In the **BOM** tool palette, select the **Attribute Selection** tool. The Message Line reads, *User Attribute Tool: Select Geometry...[Return = Append Attribute, Ctrl+Return = Remove Attribute {Windows} or Option+Return = Remove Attribute {Macintosh}]*.
8. Select the object to which attributes will be assigned.
9. Enter the desired values in the entry field in the Status Line.  
Locked attribute values cannot be edited in the Status Line.
10. Press the ENTER (Windows) or RETURN (Macintosh) key.

**Important:** The attributes are assigned only after pressing ENTER (Windows) or RETURN (Macintosh).

#### Tip:

To assign attributes to an object made up of several individual objects, like a rectangle, made up of four single lines, group the object before assigning attributes. Otherwise, the attributes will be assigned to each individual object selected.

## Symbol Attributes Tool



This tool marks a symbol with assigned attributes.

Graphite doesn't recognize any difference between drawings and symbols. They are only opened by different commands:

- Drawings are opened by choosing **File>Open**.
- Symbols are inserted by choosing **File>Symbol>Insert**.

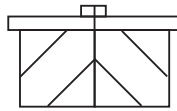

Attribute	Value
Name	Wedge
Material	Steel
Quantity	1

Symbol attribute tables cannot be edited. They must be deleted and reinserted.

### Marking an Object as a Symbol

With the **Symbol Attributes** tool, mark an object with a small table containing all assigned attributes. This table is interpreted when the object is placed as a symbol.

When this object is inserted with the *Symbol* command all attributes contained in this table are listed in the Symbol dialog box. Values of unlocked attributes can be edited before the symbol is placed—without the attributes table—in the drawing area.

Symbol Attributes do not attach to the objects in the symbol file like object attributes. Instead, Symbol Attributes attach to the symbol when the symbol is inserted into a drawing.

When opening a marked symbol by choosing **File>Open** the attributes table appears in the drawing area with the symbol.

1. In the **BOM** tool palette, choose the **Symbol Attributes** tool. The Message Line reads, *BOM Symbol Attribute Tool: Select Insertion Point*.



2. Enter the values for the attributes in the Status Line.

3. Click to place the Symbol Attributes table in an empty spot in the drawing area.

A table with all assigned attributes appears with the values entered in the Status Line.

4. Save the object with the Symbol Attributes table.

The attributes in this table attach to the symbol when it is placed using the **Symbol** command, and the assigned values can be changed in the Symbol dialog box. There should be only one symbol table per file.

If a symbol holding object attributes are placed in the drawing, but no Symbol Attributes table is included, the object attributes do not display in the Symbol dialog box and do not get attached to the symbol when it is placed in the new drawing. To access the object attributes, the symbol must first be ungrouped.

An object can have both object attributes and symbol attributes, and their values do not have to be the same.

## Editing Attributes

Assigned attributes display in the Status Line, where the default values are edited.

### Showing Attributes

1. In the **BOM** tool palette, select the **Attribute Selection** tool.



2. Move the mouse pointer over the drawing area. As soon as the pointer comes near an object with assigned attributes, these attributes and their respective values automatically display in the Status Line.

**Important:** Attributes must be visible (eye icon displaying) and the proper layout must be active, as indicated in the Define Attributes dialog box and in the Define Layouts dialog box in order to display assigned attributes in the Status Line.

*Tip:*

Values of attributes can also be edited in the Edit Objects dialog box. To do so, select the object, choose **Edit>Edit Objects**, change the value in the Edit Objects dialog box and click Apply.

## Changing the Values of Attributes

1. In the **BOM** tool palette, select the **Attribute Selection** tool.



2. Move the mouse pointer near an object with assigned attributes.  
The attributes and their respective values display in the Status Line.
3. Select the object with the **Attribute Selection** tool.
4. Change the respective values in the Status Line. To remove an attribute value, delete the value in the entry field.
5. Press the ENTER (Windows) or RETURN (Macintosh) key.  
The changed values are assigned to the selected attribute.

## Removing Attributes

1. In the **BOM** tool palette select the **Attribute Selection** tool.



2. Move the mouse pointer near an object with assigned attributes.  
The attributes and their respective values display in the Status Line.
3. Select the object with the **Attribute Selection** tool.
4. Press the CTRL+ENTER keys (Windows) or the OPTION+RETURN key (Macintosh) simultaneously. All visible and unlocked attributes are removed.

## Item Numbers

The **BOM** tool palette assigns item numbers to objects which will be automatically included in the Bill of Materials table.

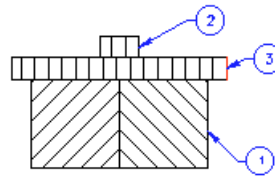

Item	Name	M-Nr.	Qty
1	Bush	M 237	1
2	Screw	M 79	1
3	Flange	M 861	1



## Assigning Item Numbers

Item numbers are assigned with the **Item Number** tool in the **BOM** tool palette.

Do not use Graphite's **Balloon** tool from Graphite's **Dimension** palette to assign Item Numbers for objects to be listed in the Bill of Materials. Item Numbers created with the **Balloon** tool are not recognized by Graphite's Bill of Materials Extraction utility.

### *Item Number Tool*



With this tool in the **BOM** tool palette, assign Item Numbers to objects. These Item Numbers will automatically be included in the Bill of Materials.

### Using the Item Number Tool

1. In the **BOM** tool palette, select the **Item Number** tool. The Message Line reads, *Item Number Tool: Pick BOM geometry to point to... [Ctrl = Renumber]*.
2. Three entry fields display in the Status Line: Item, Width and Size.
3. Enter the starting item number for the selected object into the Item field.  
Item Numbers can also contain alpha characters—A, B, C, etc.
4. Click the **Item Number** tool near the object to be labeled.
5. Click with the **Item Number** tool in the drawing area to indicate the position of the Item Number balloon.

The Item Numbers are placed at the clicked location.

When placing additional position balloons the Item Number automatically increases. The default Item Number always increments from the last Item Number used.

If an Item Number is assigned to an object already assigned to another object, the item numbers adjust as follows:

- If the new Item Number is lower than the highest Item Number already assigned, all higher Item Numbers increase.
- If the new Item Number is higher than the highest assigned Item Number, the existing Item Numbers remain unchanged.

More than one Item Number cannot be assigned to an object. If so, the original Item Number balloon deletes. To get the original Item Number back, do an *Undo*.

## Adjusting Item Number Balloon and Text Size

The following procedure describes how to adjust the Item Number balloon and Text size before assigning any Item Numbers.

1. In the **BOM** tool palette, select the **Item Number** tool.



The entry fields, Item, Width and Size, display in the Status Line.

2. Press the TAB key twice and enter the desired width for the Item Number balloon. The units for the indicated width are based on the unit specified in the Units dialog box from the **Layout>Preferences>Units**.
3. Enter the desired size.  
The text size of the Item Number balloon is now set.
4. Select the desired text size.  
The text size of the Item Number balloon is now set.
5. Press the ENTER (Windows) or RETURN (Macintosh) key.  
The size of the Item Number balloon is now set.

### Tip:

An Item Number's font is specified in the Font submenu of the Dimension menu.

## Editing Item Numbers

Item Number, Text Size and the Size of the Item Number balloon can be changed.

### ***Editing the Size of an Existing Item Number Balloon***

1. Select the desired Item Number balloon.
2. Choose **Item Number Tool**.
3. In the Status Line, enter the new diameter in the width field.
4. Press the ENTER (Windows) or RETURN (Macintosh) key.  
The diameter of the selected Item Number balloon updates accordingly.

### ***Editing the Text Size***

1. Select the respective Item Number balloon.
2. Choose **Edit>Edit Objects**.
3. In the Status Line, enter the new Text Size in the size field.
4. Press the ENTER (Windows) or RETURN (Macintosh) key.  
The text size of the selected Item Number balloon update accordingly.

Item Number text size can be changed dynamically by selecting the Item Number balloon and changing the size in the Dimension menu.

### Tip:

The shape of the Item Number balloon can also be changed in Edit Objects. If existing Item Numbers are renumbered, all Item Number balloons revert to the default circle balloon.

### Deleting Item Numbers

1. Select the desired Item Number balloon.
2. Select **Edit>Delete** or press the BACKSPACE (Windows) or DELETE (Macintosh) key.

The selected Item Number will be deleted.

### Renumbering Existing Item Numbers

1. In the **BOM** tool palette, select the **Item Number** tool.



The entry fields, Item, Width and Size, display in the Status Line.

2. Enter in the Item field the new starting number for the Item Number, press the ENTER (Windows) or RETURN (Macintosh) key.
3. Press the CTRL (Windows) or OPTION (Macintosh) key and keep it pressed.
4. Click the Item Number balloons in the desired order.

The Item Number balloon will split. The upper half of the symbol shows the old Item Number and the lower half of the symbol the new Item Number.

5. Release the CTRL (Windows) or OPTION (Macintosh) key.

All Item Numbers renumber.

### Item Numbers and Object Copies

The **Item Number** tool automatically recognizes if an object is a copy of an object to which an Item Number is already assigned, as long as the original object has an attribute of the *Quantity*. The **Item Number** tool automatically assigns the identical Item Number of the original object to the object copy.

### Bill of Materials

After assigning attributes to objects, create a Bill of Materials. The Bill of Materials will contain all Item Numbers and their associated attributes.

3	Pin	E-227	Aluminum	1	2	ACNE
2	Link	M-612	Aluminum	5	2	ACNE
1	Block	M-1217	Aluminum	2.5	1	ACNE
	Item	Part Name	Part Number	Material	Cost	Quantity Vendor

The Bill of Materials is placed on the current sheet. Move it to another location, copy it to another sheet or export it into an ASCII file to use it in other programs like spread sheets or text editors.

In order to create a Bill of Materials, first define a layout.

## Bill of Materials Layouts

The *Layouts* command defines different layouts for the Bill of Materials and is used in conjunction with the Define Attributes dialog box. To define layouts, choose **Text>Bill of Materials>Define Layouts**.

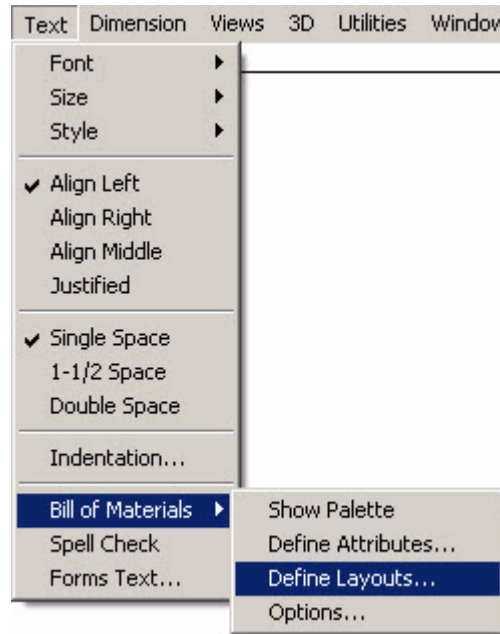

### **Layouts Command**

The *Layouts* command, in the BOM submenu of the Text menu, displays the following dialog box:

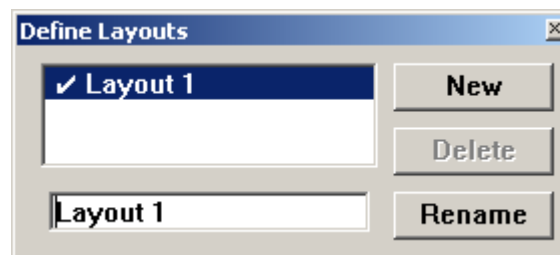

Layouts differ only by the attributes to which they relate. A layout contains all the visible attributes listed in the Define Attributes dialog box. (Visible attributes are indicated by a check mark.) Therefore, the Define Attributes dialog box should be displayed when defining a layout.

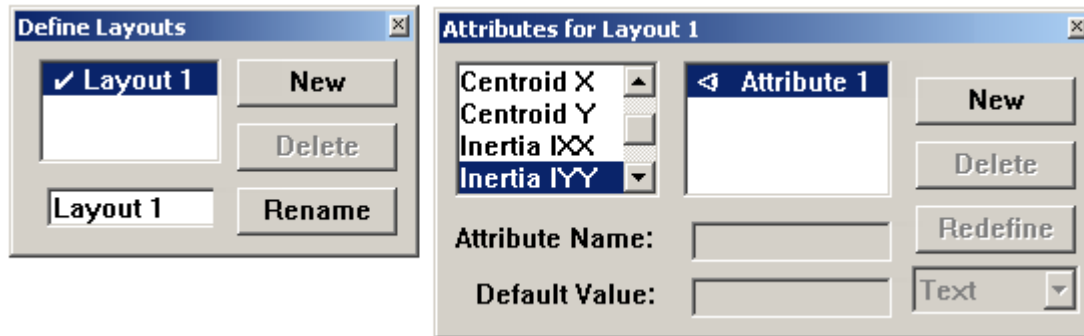

### Defining a New Layout

1. Choose **Text>Bill of Materials>Define Layouts**.

The Define Layouts dialog box appears.

2. Click New.
3. Rename the layout in the Layout Name entry field.
4. Click Rename.
5. Double click to activate/set.
6. Select the **Text>Bill of Materials>Define Attributes**.

The Define Attributes dialog box displays.

7. Define all the attributes to be used in different layouts.
8. Make all the attributes visible to be saved under one layout name.

All active attributes in the Define Attribute dialog box are automatically saved under the current layout name for the current Graphite session. To save layouts permanently, choose **Layout>Preferences>Save Preferences**.

## Editing Layouts

1. Choose **Text>Bill of Materials>Define Layouts**.

The Define Layout dialog box displays.

2. Double click to activate/select.
3. Click Current.
4. Select the **Text>Bill of Materials>Define Attributes**.

The Define Attribute dialog box displays.

5. Show or Hide the attributes as desired.

All changes made in the Define Attribute dialog box are automatically saved under the current layout name. To save the changes permanently, choose **Layout>Preferences>Save Preferences**.

## Layout Options

For all BOM layouts defined, some of the preferences can be set globally.

Select the **Text>Bill of Materials>Options** and this dialog box displays.



The screenshot shows the 'Options' dialog box with the following settings:

- Ballooned Only**
- Export Headline**
  - Headline Color: Blue
- Show Item Number Header**
  - Item Number Header: Item
  - Sort By: Item
  - Draw Table: Ascending
- User Widths**
  - Edit Widths...
- Table Margin: 0

Buttons: Cancel, Apply

<b>Ballooned Only</b>	Places only BOM items in the table that have an associated BOM Balloon in the file.
<b>Export Headline</b>	Draws the header line in the table.
<b>Show Item Number Header</b>	Creates an Item column as the first column.
<b>Item Number Header</b>	Names the Item column.
<b>Table Margin</b>	Designates the margin between the text and the vertical column guides.
<b>Headline Color</b>	Designates a color for the title text.



To choose a color, click into the pop-up menu and drag to the desired color. As soon as the mouse is released the selected color displays in the pop-up menu.

<b>Sort by</b>	Selects the attribute by which the Bill of Materials should be sorted. Click into the pop-up menu with the left mouse button pressed and drag to the desired attribute. When released, the selected attribute displays in the pop-up menu.
<b>User Widths</b>	Activates the Edit button. Clicking Edit displays a dialog box to define the column width of the Bill of Materials table.
<b>Draw Table</b>	Selects whether the Bill of Materials is drawn from the <i>Top Down</i> or from the <i>Bottom Up</i> .

### **User Widths**

Specifies the width of the BOM columns individually.

The Edit button activates. Clicking Edit displays the following dialog box:

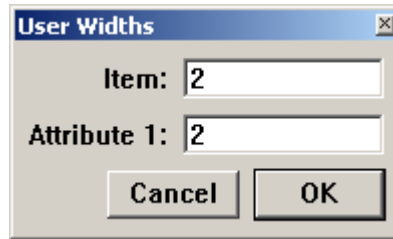

In this dialog box all attributes of the actual layout appear. For each attribute the respective column width displays. The displayed values for the column widths are calculated by the word length of each attribute and the indicated margin. Change the width for each column individually. All specified values are based on the units set in the Units dialog box (**Layout>Preferences>Units**).

### **Attribute Order**

The order by which the attributes displays in the Bill of Materials is determined by the order the attributes were defined in the Define Attribute dialog box and cannot be changed in this box.

*Tip:*

Macintosh users: drag the attribute names in the Attribute List in the Define Attributes dialog box to change the order.

## **Creating A Bill of Materials**

A Bill of Materials contains all the Item Numbers and their associated attributes. The generated Bill of Materials is an object in Graphite like any other object geometry. That means it can be moved, copied, deleted and edited. Create a Bill of Materials with the **Bill of Materials** tool in the **BOM** tool palette.

### **BOM Tool**



This tool, in the **BOM** tool palette, generates a Bill of Materials of the current model and places it on the current sheet. Its insertion point is based on the Draw Table setting in the Options dialog box.



### Creating a Bill of Materials for the Entire Drawing

1. Choose **Text>Bill of Materials>Show Palette**.

The **BOM** palette displays.

2. Select the **BOM** tool. The Message Line reads, *BOM Tool: Pick Insertion Point [Ctrl = Selection Only {Windows}, OPTION = Selection Only {Macintosh}]*.
3. Click in the drawing area to indicate the location to display the Bill of Materials.

The Bill of Materials of the current layout appears at the selected location. The Bill of Materials uses the font currently selected in the Text menu. It can be moved, copied or deleted like any other object in Graphite.



### Creating a Bill of Materials of Selected Objects

1. Select all objects to display in a Bill of Materials.
2. Choose **Text>Bill of Materials>Show Palette**.

The **BOM** palette displays.

3. Select the **BOM** tool.



4. With the CTRL (Windows) or OPTION (Macintosh) key pressed, click in the drawing area to indicate where to place the Bill of Materials.

A Bill of Materials containing the selected objects is created and placed at the location indicated with the last mouse click.

### Editing a Bill of Materials

1. Select the Bill of Materials with the **Selection** tool.
2. Choose **Arrange>Ungroup**.

The Bill of Materials ungroups into text and line objects that can be edited.

## Exporting a Bill of Materials

Attributes assigned to objects in a drawing can be exported into an ASCII file for use in other programs like text editors or spread sheets.

To export a Bill of Materials, select the **File>Export**. The displayed Export dialog box contains the export option *Bill of Materials*.

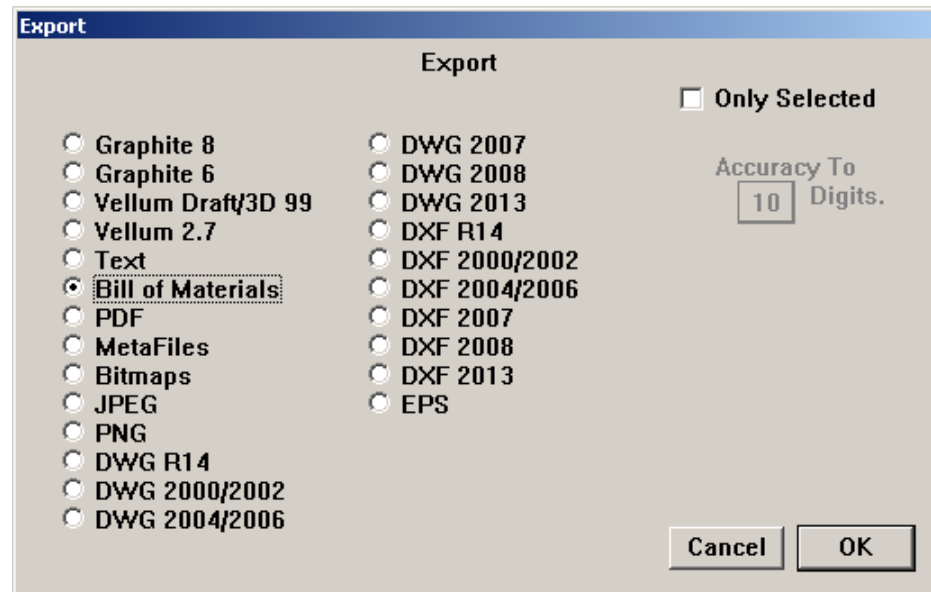

### Exporting a Bill of Materials

1. Select **File>Export**.

The Export dialog box displays.

2. Mark the *Bill of Materials* option.
3. Select the *Only Selected* option to export attributes only from selected objects and not from the entire drawing.
4. Click OK and provide a file name and location.

The Item Numbers and attributes of the entire drawing or of the selected objects only export into an ASCII file.

# GD&T

GD&T stands for Geometric Dimensioning and Tolerancing, a U.S. government standard. This GD&T capability is compliant with ANSI Y14.5 (1985), DIN, ISO and JIS standards.

Since this annotation may be new to you, this section includes an overview of GD&T standards and a brief explanation of the components of a GD&T label, using the true position of holes as an example. The topics covered include:

- Background
- Alignment Information
- Bonus Tolerance
- Basic Dimensions
- GD&T Feature Control Frame
- Geometric Characteristics
- The GD&T Label

## ***Background***

Before World War II, a single vendor did most military manufacturing for a particular part of product. During the war, however, it became a matter of national security to diversify weapons manufacturing so a single plant was not the only source of a vital part. When more than one manufacturer interpreted specifications and blueprints, difficulties arose.

When several companies manufacture the same part, each must drill holes within the same tolerance for the parts to be interchangeable. Even though manufacturers thought they were following the tolerance specifications, the parts were not interchangeable. The problem arose from the order in which measurements were made.

## ***Alignment Information***

A part was usually laid on a flat surface (A) and aligned first with one straight edge (B), then with another (C).

If one manufacturer aligned with edge B, then edge C, but another aligned with edge C, then edge B, the resulting measurements would probably be different. The GD&T standards tell a manufacturer the order of alignment.

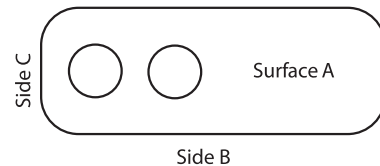

## Bonus Tolerance

In addition to the alignment information, a manufacturer gets a bonus from GD&T tolerances. In conventional drafting, the tolerance for hole drilling results in a square target area. For example, examine the plate on the left below. The positional tolerance for the hole is  $\pm 0.001$ . The target area (magnified and shown on the right) is from  $.001$  left of the perfect center to  $.001$  right of the perfect center, and  $.001$  above the perfect center to  $.001$  below the perfect center.

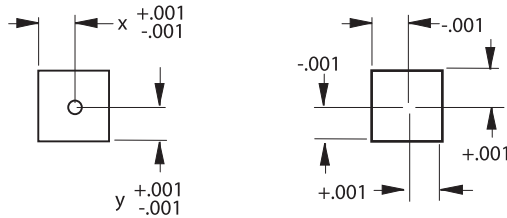

GD&T provides a circular target area for the hole. First measure from the center in one direction by the distance of the tolerance; then measure the same distance perpendicular to that point.

Then use the distance from the endpoint of the second line to the perfect center as the radius of a circle to create a circular target—the bonus tolerance.

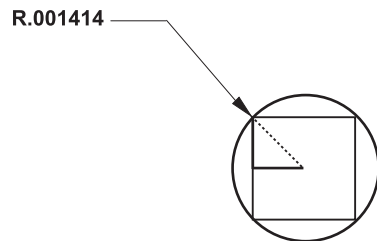
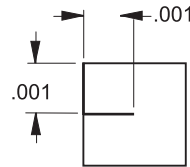

In that way, the target area for the hole's center is the area circumscribing the square of standard dimensions.

The standard information (basic dimensions) about the target area appears in a box with a GD&T feature control frame.

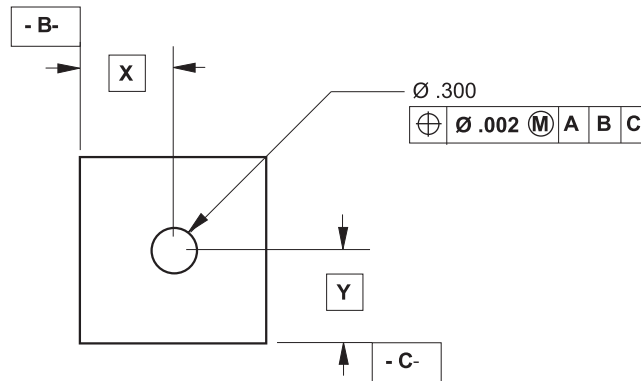

## ***Basic Dimension***

Since the tolerance for a dimension is in the feature control frame, GD&T dimensions are also basic dimensions and appear in a box. The value defines the theoretically perfect location and implies that the tolerance is in the feature control frame.

To specify the basic dimension format, in the Dimension menu, go to the Linear and Angular submenus, and choose [xxx] (basic).

## GD&T Feature Control Frame

This section discusses the GD&T labeling of the left hole in the plate below.

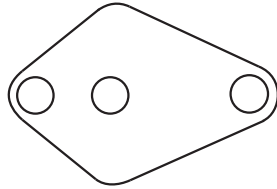

Typically, the GD&T feature control frame appears as shown below:

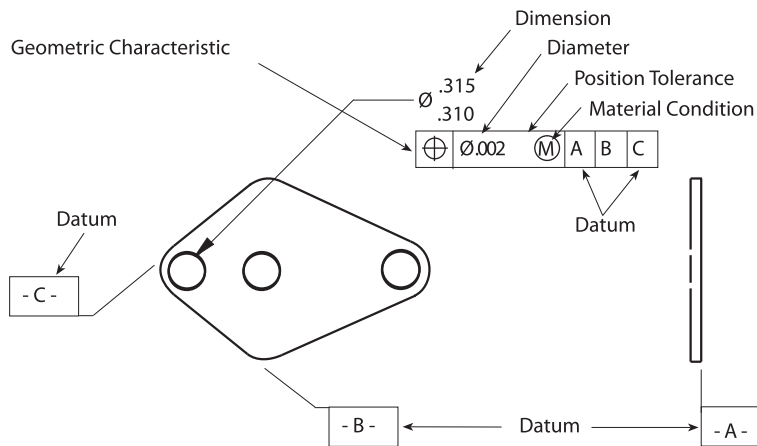

## Geometric Characteristics

The first section of the feature control frame contains the geometric characteristic symbol. The feature control frame on the previous page describes True Position—how to locate the circular target area for the hole. The possible characteristics are as follows:

### — Straightness

The axis of an item of revolution or element of a surface is a straight line.

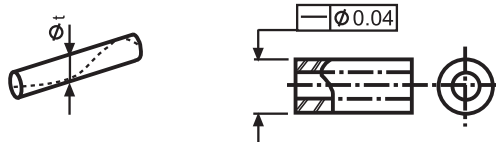

 **Flatness**

All elements of a surface in one plane.

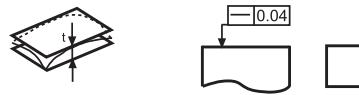

 **Roundness**

All points of a surface of revolution equidistant from an axis that is intersected by a plane perpendicular to that axis.

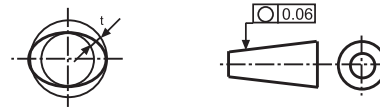

 **Cylindricity**

All points of a surface of revolution equidistant from a common axis.



 **Profile of Line**

A 3D element projected to a plane.



 **Angularity**

An axis or planar surface at a specified angle from another axis or datum plane.

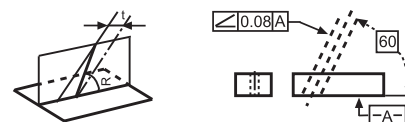



**⊥ Perpendicularity**

An axis or planar surface at a right angle to a datum axis or datum plane.

**// Parallelism**

An axis or planar surface equidistant along its length to a datum axis or datum plane.

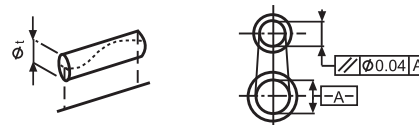
**⊕ True Position**

A zone of tolerance for a center axis or center plane.

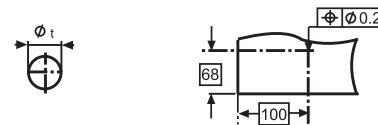
**◎ Concentricity**

The axes of all elements in a cross-section share a common datum axis.

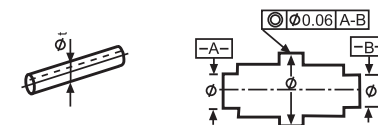
**≡ Symmetry**

The location of a feature relative to a center plane.

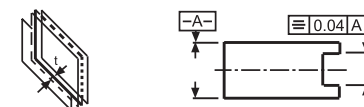

### ↗ Circular Runout

Circular elements of a surface of revolution associated with a datum axis.

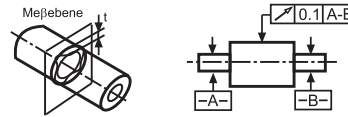

### ↗ Total Runout

All elements of a surface of revolution associated with a datum axis.

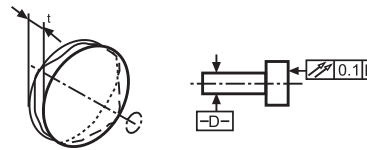

#### Tip:

If the diameter symbol is appropriate for the geometry, it should be displayed. It is usually not used with flatness, roundness, cylindricity, profile of line or surface, angularity, circular or total runout.

## Diameter

The second section of the feature control frame specifies whether the tolerance applies to a circular zone. If it does, specify the diameter symbol ( $\varnothing$ ) from the pop-up menu.

## Position Tolerance

The third section of the feature control frame defines the tolerance allowed under the stated conditions.

## Material Condition

The fourth section of the feature control frame provides the material condition for limiting the tolerance. Use any of three material conditions: Maximum, Least and Regardless of Feature Size.

### Maximum Material Condition

Maximum Material Condition (MMC) indicates that a feature contains the maximum amount of material within the specified tolerance limit. For drilling holes, MMC means that the drill bit is accurate—it drills the smallest hole. For shafts, MMC results in the largest dimension.

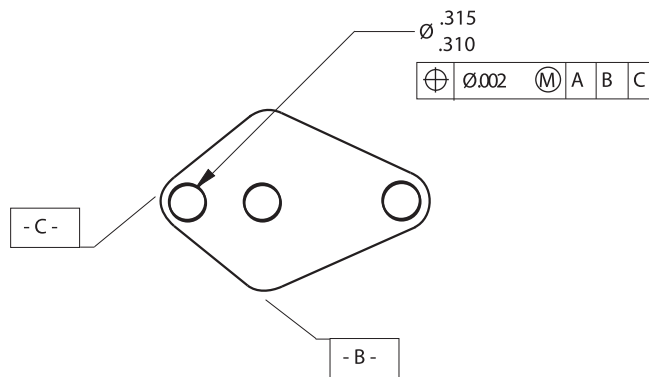

*Tip:*

Maximum Material Condition is the most commonly used symbol for parts.

In the example above, this material condition symbol means that the tolerance in the feature control frame (.002) applies to the location of the smallest hole (.310 in this case). As the hole size nears its upper limit (.315), the location of the hole increases from .002 to .007 (the tolerance for the location, .002, plus the tolerance for size, .005).

### Least Material Condition

Least Material Condition (LMC) indicates that a feature contains the minimum amount of material within its specified tolerance limit. For holes, the swept area is the largest and the drill bit drills the largest hole. For shafts, the tolerance is the smallest allowable dimension.

In the example above, this material condition symbol means that the tolerance (.002) applies to the location of the largest hole (.315). As the hole size nears its lower limit (.310), the tolerance for the location of the hole increases from .002 to .007 (the tolerance for the location, .002, plus the tolerance for size, .005).

*Tip:*

Least Material Condition is most frequently used to control wall thicknesses of parts, as well as for tool fixtures and inspection gauging.

### Regardless of Feature Size

The Regardless of Feature Size (RFS) material condition means the tolerance applies regardless of the size of the feature (within the specified tolerance limit). For holes, the location tolerance is the same regardless of whether the hole is the smallest or largest allowable size. For shafts, the roundness tolerance is the same regardless of the shaft diameter.

In the example above, this material condition symbol in the feature control frame (.002) applies to the location of the hole whether the hole is at its smallest (.310) or largest (.315). This material condition would control an axis in space, so you probably wouldn't use Regardless of Feature for this hole.

### Datum

The last three sections of the frame show the alignment order to position the part. This is easier to see in a part which does not have perpendicular sides. A typical engineering drawing might appear as shown below:

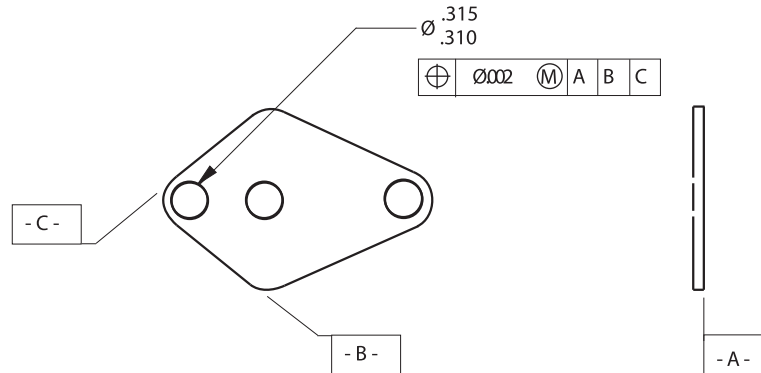

For proper drilling alignment and measurement, this part would lie on a flat surface (Surface A), with Side B pushed against the first straight edge, and then Side C pushed against the other straight edge.

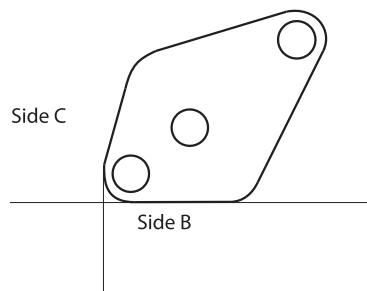

GD&T tells a manufacturer which surface to align first. If the part is aligned with Side C before Side B, the holes do not line up in the same way as they would if Side B was aligned before Side C.

The rule for points of contact per surface is as follows:

<i>Surface</i>	<i>Point of Contact (minimum)</i>
1st	3
2nd	2
3rd	1

## Datum Material Condition

When showing a datum in a feature control frame, there is also the option of indicating a material condition. Such a modifier should only be specified for a datum that is an axis or centerplane of a feature, such as a hole or boss. Material Condition modifiers do not apply to planes such as the straight side or flat bottom of a part.

## Composite GD&T Symbols

A composite symbol uses more than one line of the feature control frame to specify more than one tolerance for the same feature.

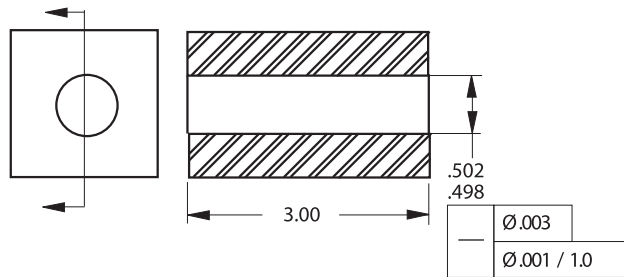

The first line of the feature control frame means that the hole must be straight throughout within a cylindrical tolerance of .003 diameter for the total of its length, 3.00 inches. The second line of the frame means that the hole must be straight for any 1.00 inch portion within a cylindrical tolerance of .001 diameter. Graphite creates the composite frame automatically if the same symbol is in *Line 1* and *Line 2* of the dialog box.

## Projected Tolerance Zone

This entry box of the feature control frame specifies an area above the actual part where the tolerance of a feature should still apply if the feature were extended or projected into the area. For example, if an outboard motor has a hole in the housing, the hole has to be straight not only through the housing, but also down into the propeller assembly, so that the drive shaft aligns properly.

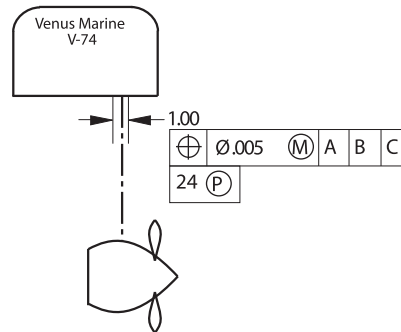

In the motor example, the tolerance for the hole should be checked **24** inches from the actual hole.

## The GD&T Label

### GD&T Command

The *GD&T* command in the Dimension menu creates a label, a feature control frame for showing dimensions, alignment, and tolerances. The dialog box looks like a complex GD&T symbol into which the information can be entered.

The GD&T label uses Plotter fonts so the font size corresponds to ANSI standards, since the sizes of other fonts are not always consistent with ANSI standards. If the size of the dimensions needs to be the same as the font in a GD&T label, select the dimensions and change the font size or choose the plotter font.

The GD&T dialog box resembles a GD&T label. For 3D geometry, GD&T labels are created parallel to the work plane.

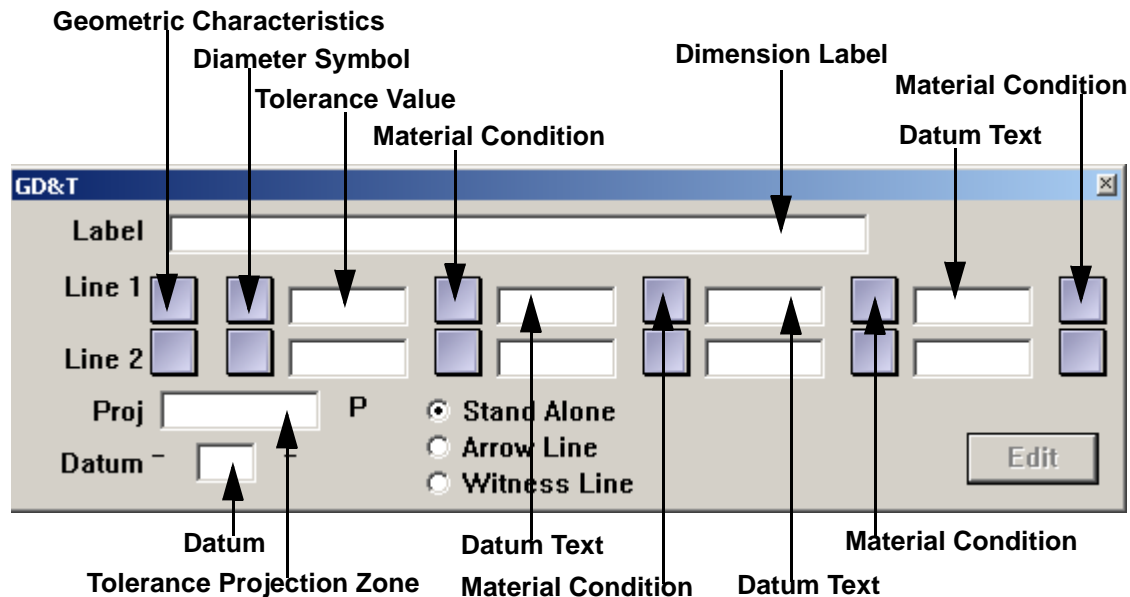

The square boxes are pop-up menus from which symbols are selected. Use a single entry, a line, or a combination of lines as needed to specify the GD&T dimensions for the part.

### Creating a GD&T Label

1. Choose **Dimension>GD&T**. The GD&T dialog box appears.

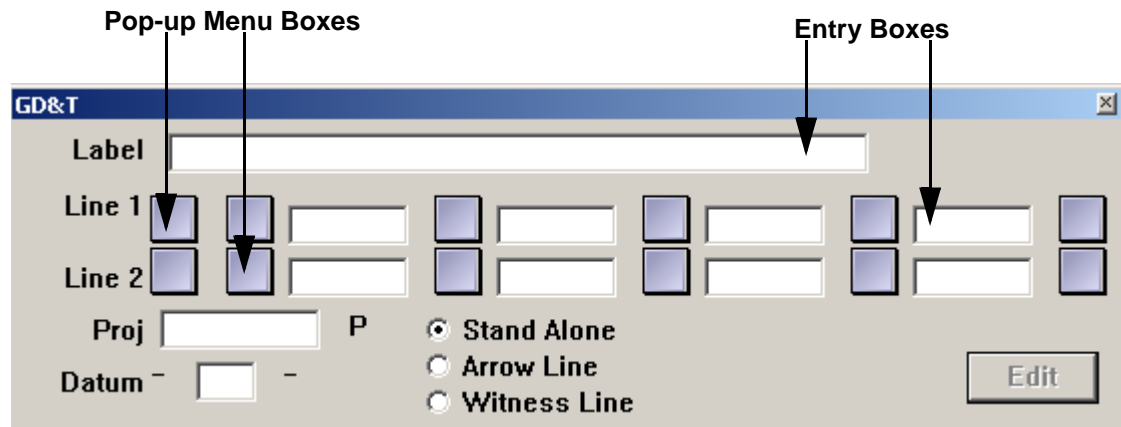

2. Click a button (Stand Alone, Arrow Line, or Witness Line) to indicate the way the GD&T symbol is connected to the geometry being labeling.
3. Enter the appropriate data to create the GD&T label. Make two types of entries in this dialog box:
  - Select symbols from pop-up menus that appear when pressing the square buttons.
  - Enter text in the rectangular fields by clicking to place a text cursor, and then typing the entry.
4. Indicate the location of the label. The Message Line guides each successive step.
  - For a Stand Alone label, click the location for the upper-left corner of the GD&T label.
  - To connect a label with an *Arrow Line* or *Witness Line*, click on the geometry to be labeled, and then click on the drawing area to indicate the position for the upper-left corner of the label.



### Editing a GD&T Label

Once a GD&T label is created, it is possible to make changes.

1. Select the GD&T label to be edited.
2. Choose ***Dimension>GD&T***.  
The GD&T dialog box appears, displaying the current GD&T information.
3. Make the changes in the GD&T dialog box.
4. Click Edit.  
The GD&T label changes.

### Using an Editing Shortcut with GD&T

When editing a GD&T label or creating a second label, every entry in *Line 1* or *Line 2* can be removed.

1. Press the first field to display the Geometric Characteristic menu.
2. Drag to the X symbol.  
All entries in the line disappear.



---

# Appendix A: Operators and Units

This appendix describes mathematical and conditional operators.

## Mathematical Operators

Entry boxes that accept numbers also accept mathematical, trigonometric and exponential operators in the form:

*funcName (arg1; arg2; . . . ; argN)*

<b>Operator</b>	<b>Example</b>	<b>Operator</b>	<b>Example</b>
Addition	3+.450	Arctangent	atan(1;1)
Subtraction	3-.500	Log (Base 10)	log(7.25)
Multiplication	3*.725	Natural Log (Base e)	ln(8.5)
Division	3/5.25	Remove Fractional Part	truncate(6.125)
Square Root	sqrt(8.75)	Absolute Value	abs(-47+16)
Parenthetical	3/(5*2/4)	Smallest Larger Integer	ceiling(5.25)
Scientific Notation	4e-3	Largest Smaller Integer	floor(12.75)
Exponentiation	exp(2;7)	Negative Value	neg(11.12)
Sine of Angle	sin(15)	Round	round(11.12)
Cosine of Angle	cos(30)	Random # in range 0 to 2 <sub>31</sub>	rand()

Math operators are case-sensitive so be sure to type them in lower case when using them. Use these operators to edit objects, make entries in the Status Line and specify values in dialog boxes.

## Conditional Expressions

Conditional expressions are particularly useful with parametrics when an expression depends on a condition. For example, a flange might depend on the

diameter of a pipe but should never be smaller than some minimum size. Use two function forms of conditional expressions, *ifelse* and *RNG* (range).

*ifelse* (*condition*; *expression1*; *expression2*)

<b>Condition</b>	<b>The result of a boolean expression:</b>
==	equals
!=	not equals
>	greater than
>=	greater than or equals
<	less than
<=	less than or equals
&&	logical and
	logical or
!	logical not
expression1	The value of the <i>ifelse</i> function if the condition is true.
expression2	The value of the <i>ifelse</i> function if the condition is false.

The following examples show boolean expressions and an *ifelse* statement:

Length > 5	The length is greater than 5
(L <3)    (W >=2)	Either the length is less than 3 or the width is greater than or equal to 2.
3*ifelse (A>B; A; B)	Evaluate three times the maximum of the variables A and B, returning 3*A if A is larger than B and 3*B if B is larger than A.

The range function is a more general form of conditional expression.

*RNG* (*T*; *V1*; *N1*; *V2*; *N2*; *V3*; *N3* ... *Vi*; *Ni*; *Vi* + 1)

In this function, the first argument (*T*) is tested against every *N* value in the other arguments and returns the value (*V*) that lies between the two *N* values that bracket *T*. Each of the test *N* values must be greater than the preceding *N*.

For example, the expression

---

RNG (A; -1; 10; 0; 20; 1)      returns -1 if A is less than 10  
0 if 10 <= A <20  
1 if A >= 20

## Units of Measure

Use different units of measure such as inches ("), feet ('), inches and feet (x'y"), millimeters (mm), centimeters (cm) and meters (m). It is possible to mix the units in the mathematical expression as long as the units are labeled properly, for example, **10" + 25.4 cm**.

### ***Nanoseconds***

Graphite is well-suited for computer hardware design, such as diagrams of timing devices. For example, draw in nanoseconds (a billionth of a second). Designs which include nanoseconds typically consist of wave forms made of horizontal and vertical lines which mimic the functions of a timing device.

The concept for using nanoseconds is to relate time with distance.

1. Specify millimeters as the unit of measure by choosing ***Layout>Preferences>Units***.
2. Choose ***Layout>Preferences>Grid***.
3. Set the grid spacing to 34 and the number of subdivisions to 2.  
A megahertz is approximately 34 nanoseconds and this becomes the base cycle, with two tick marks for drawing half cycles.
4. Turn on the grid.
5. Use the **Connected Lines** tool to draw the wave form of the desired specifications.
6. Use the **Expand/Shrink** tool to stretch the wave form to half and full cycles.

*Tip:*

It is possible to place the *constraint lines* on another layer and hide them.

### Using Parametrics for Wave Forms

Use parametrics to speed up this process, as shown below. The dotted lines are constraint lines.

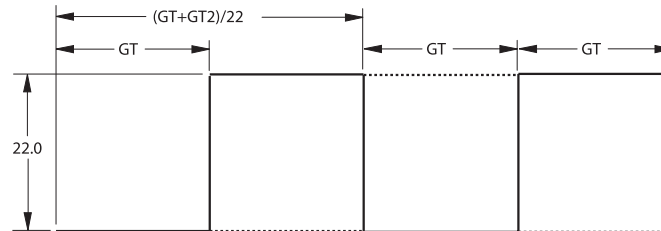

### Decimal Indicators

International numeric keypads have a comma in place of the period because Europeans use commas in decimal expressions.

Graphite can handle both American and European decimal entries in the Status Line (24,5 or 24.5), however, the display is controlled by the Numbers Control Panel.

### Keyboards and Command Keys

Since keyboards vary from country to country, the Graphite command keys may not respond as described with a non-American keyboard.

---

# Appendix B: Special Characters

It is possible to use special characters and accents which are available with the computer. Usually these characters are described in an appendix of the computer's user manual. Many symbols and characters are accessed from the keyboard.

## *Windows*

If necessary, unlock the keypad with the NUM LOCK key, and then hold down the ALT key and enter the numeric code for the necessary character.

The character appears in the current font (including Graphite's Plotter fonts). The following list includes common symbols which are available in all fonts:

<b>Accent</b>	<b>Key Combination</b>
°	ALT 0176
∅	ALT 0216
±	ALT 0177

*Tech Note:*

Numeric values must be entered with an enhanced 101 keyboard using the separate number pad.

## ***Macintosh***

Use the OPTION key to generate international accents in the current font, including Graphite's Plotter fonts.

<b>Accent</b>	<b>Key Combination</b>
é	OPTION+e then letter to be accented
è	OPTION+` then letter to be accented
ñ	OPTION+n then letter to be accented
ü	OPTION+u then letter to be accented

The following list includes common symbols which are available in all fonts.

<b>Accent</b>	<b>Key Combination</b>
°	OPTION+ SHIFT 8
ø	OPTION+ O (letter or number)
±	OPTION+SHIFT =

## ***Adding Special Symbols to the Dimensions Text***

1. Select the dimension you need to add special symbols to.
2. Open the Edit Objects window. Next to the Text entry field there is  button. Click the button and the drop down list of symbols appears. Choose the one you need.
3. Click ENTER. The symbol appears in the dimension text.



---

# Appendix C: Program Settings & Files

For your convenience, this appendix includes the default settings present for first installing the program. It also includes a list of all the folders and files that come with the program.

## Default Settings

The default settings are contained in the *Prefs.VC6 (Windows)* or *Graphite Prefs (Macintosh)*. Change these setting by opening this file, making the changes and then saving the file. See Chapter 5, Basic Environment Settings for more information.

Once new preferences are saved, the previous default settings are no longer available. The following are the default settings that came with the program according to the pull down menus:

### Edit menu

Selection Mask	All Selected
Selectable Points	On

**Layout** menu

Preferences Submenu

Units

Precision 0.001

Inches

\* All others off

Selection Color Red

Invert White

DA On

Autosave Off 15 min.

Layers Construction, Dimension, Layer1, Constraint

**Arrange** menu

Divide

# of pieces 2

Show Points On

**Pen** menu

Style Outline

Color Black

Weight 0.010

Pattern Solid

Arrowheads Standard

Arrow at Start Off

Arrow at End Off

**Text** menu

Font Plotter (Windows); Geneva (Macintosh)

Size 12 pt

Style Normal

Align Left On

Single Space On

---

### Dimension menu

Linear	.xxx xxx
Linear Tol	.xxx
Angular	xx.xx° (Windows); Whole Degrees (Macintosh) xxx
Angular Tol	xx.xx° (Windows); xx.x° (Macintosh)
Text	Horizontal
Font	Plotter
Size	9 pt
Style	Normal
Color	Blue
Weight	.002
Layer	dimension
Arrowhead	Standard
Arrow Size	
Dot Size	.125
Length	.25
Height	.125
Side	.258
Angle:	28° 4' 21"
Witness Lines	Line at Start, On Line at End, On

### Views menu

Sheets	Sheet 1
Models	Model 1
Views	Top
View the Plane	Off
Draw View Boundaries	On
Show Trackball	Off
	WindowsUntitled

### 3D menu

Planes	Top
Show Triad	Off

### Utilities menu

Macros	Empty
Navigator	Unchecked



# Glossary

**Accelerators**

Keyboard equivalents that invoke commands rather than using the mouse to choose from menus.

**Annotation**

Text on drawings, including notes, crosshatching and dimensions.

**Apple HSL Display**

A standard color wheel for the Macintosh with the option to specify Hue, Saturation and Lightness.

**Apple RGB Display**

A standard color display for the Macintosh with the option to specify Red, Green and Blue percentages.

**Alignment**

1. The justification of text with either or both margins even or text centered within the designated text space. Alignment is set in the Text menu.

2. The spatial relationship of different sets of geometry to each other along a common line.

**Alignment Angle**

The angle of the Drafting Assistant's automatic construction lines. The specification is set by choosing **Layout>Preferences>Snap**.

**Arc Tool**

Draws a part of a circle.

<b>ASCII</b>	An acronym for American Standard Code for Information Interchange. This is the format for text characters to be imported into Graphite. Most word processors save text in ASCII format.
<b>Arrow Tool</b>	Used for selecting objects to be operated on with subsequent commands. Also used to move selected geometry.
<b>Associativity</b>	A link between an object and its dimensions or between views. If the object is changed, the dimensions automatically change to match. In associative views, such as a detail view, when geometry is changed in one view, all views of the same geometry are changed accordingly.
<b>Attributes</b>	The data fields associated with a particular object that completely define that object. This includes layer name, pen style, color, x-y-z coordinates and even data for a BOM, such as cost, item-name, quantity, description, etc.
<b>Automatic Dimensions</b>	This tool automatically places dimensions on lines, circles, ellipses and arcs with one mouse click on the geometry.
<b>Bezier Curve</b>	A free form curve. NURB splines are a superset of Bezier curves.
<b>Border</b>	A frame showing the boundary of a view.
<b>Boundary</b>	The geometry that defines the limits for operations such as trimming, relimiting, crosshatching, 2D analysis, or fill.
<b>CAD</b>	An acronym for Computer-Aided Design.
<b>CADD</b>	An acronym for Computer-Aided Design and Drafting.
<b>CAE</b>	An acronym for Computer-Aided Engineering.
<b>CAM</b>	An acronym for Computer-Aided Manufacturing.

---

<b>Chamfer Tool</b>	The tool that constructs beveled or sloping edges or a surface between two objects.
<b>Chain</b>	This entity is created when flattening a surfaced object using the <i>Flatten View</i> command. Once an object is flattened these chain entities can be edited.
<b>Characteristics</b>	See Attributes.
<b>Circle Tool</b>	Draws circles specified by the radius, the diameter, or tangency to other entities.
<b>Circle Center Line</b>	This tool places a center line on circles.
<b>Circumference</b>	The distance around a circle along its edge = $2\pi r$
<b>Circumscribed</b>	Enclosing a circle. In circumscribed polygons, the <i>midpoint</i> of each side of the polygon touches an imaginary circle (i.e. the polygon exactly surrounds the circle).
<b>Click</b>	To press and release the mouse button. To click an object, move the pointer to the object and press and release the mouse button.
<b>Clipboard</b>	The memory buffer where selections are stored when the <i>Cut</i> or <i>Copy</i> command is used.
<b>Construction Lines</b>	Lines, displayed as dotted or gray lines, used for exact alignment. The Drafting Assistant creates dynamic, temporary construction lines. Permanent construction lines can also be created then deleted.
<b>Control Point</b>	The <i>endpoint</i> or <i>midpoint</i> of an object or “knot” point defining a spline. The Drafting Assistant indicates these positions when the pointer is moved near them.
<b>Coordinates</b>	Positions on axes that specify the locations of a point. Two-dimensional graphics have x,y coordinates; three-dimensional graphics have x,y,z coordinates.

---

<b>Copy</b>	The command that places a duplicate of the selected geometry on the Clipboard. See the descriptions for the <i>Polar Duplicate</i> and <i>Linear Duplicate</i> commands and <b>Transformation</b> tools for additional copying methods.
<b>Corner Tool</b>	An editing tool that trims lines extending past their intersection or extends lines to form a corner.
<b>Crosshatching</b>	The filling of closed geometry with a line pattern.
<b>Cursor</b>	The I-beam position indicator in the text tool and boxes which use text. Elsewhere, the position indicator is called a pointer.
<b>Curve</b>	A circle, arc, ellipse, or spline.
<b>Cut</b>	The command to delete selected entities. The selection is placed on the Clipboard and can be pasted into the same or different documents or into documents created by other applications.
<b>Custom Colors</b>	(Windows only) The button in the color display that defines 16 additional colors to show in the partial color display.
<b>Dash</b>	A pen style or line pattern made up of dashes.
<b>Default</b>	Built-in settings that are used by the system if a value or choice is not specified by the user.
<b>Delete</b>	The command to erase selected geometry. The selection is not placed on the Clipboard. It can, however, be retrieved within the limits of the <i>Undo</i> command.
<b>Delta</b>	A change, usually in position.
<b>Detail View Tool</b>	The tool that creates a separate view of the indicated geometry, at the specified scale.
<b>Dialog Box</b>	A specification box that appears in response to certain commands. A dialog box provides information that qualifies the execution of those commands.
<b>Diameter</b>	The distance across an arc or circle, passing through the center.



<b>Dimension</b>	A graphical object that displays the distance between two points, a measurement of an object and also a pen style.
<b>Divide</b>	To segment a line or curve into equal parts.
<b>Double-click</b>	To press and release the mouse button twice in rapid succession.
<b>Drafting Assistant</b>	A unique Graphite feature which displays feedback notations and construction lines to aid with snap, alignment and constraint operations. The Drafting Assistant facilitates exact construction without requiring manual precision. When the pointer is close enough to display feedback, the Drafting Assistant locks onto the exact location.
<b>Drag</b>	To press and hold the mouse button, move the pointer to a new location, and release the mouse button.
<b>DXF</b>	An acronym for Data Exchange Format, a format of AutoCAD files.
<b>Drawing</b>	A 2-dimensional line art representation, usually including an orthogonal view and dimensions.
<b>DWG</b>	AutoCAD's native file format.
<b>Ellipse Tool</b>	The tool for drawing ellipses from rectangle or parallelogram specifications.
<b>Endpoint</b>	The first or last point of a line or curve. The Drafting Assistant indicates these positions when the pointer is moved near the <i>endpoint</i> of an object.
<b>Export</b>	To save a document in a file format that can be used by a different application program.
<b>EPS</b>	Encapsulated PostScript format for printing to a PostScript printer and for importing into compatible applications.

<b>Eye Dropper</b>	The Eyedropper tool copies properties from a selected entity to another entity, including lines, fonts, layers or dimensions. For text the properties include font, size and color. For dimensions it includes text location, font, size, style, colors, line weight, layers and arrow head on/off.
<b>File</b>	An individual document.
<b>Fillet Tool</b>	A tool that creates an arc of a specified radius tangent to entities.
<b>Flatten</b>	To convert a view of a 3D model into a 2D plane. Flattening disassociates a view from a model, allowing independent editing.
<b>Font</b>	The assortment of type used in text.
<b>Forms</b>	The command to create standardized title blocks.
<b>GD&amp;T</b>	Drafting notations for Geometric Dimensioning and Tolerancing.
<b>Geometry</b>	The objects used to construct parts.
<b>Grid</b>	The rectangular array of lines that facilitates measurement and alignment. The grid display can be turned on or off, and the spacing can be specified through the Layout menu.
<b>Group</b>	To specify several entities as one unit that will be treated as a single object.
<b>Hidden</b>	A line pattern or pen style used to draw lines that would not be visible in a solid part. Drafters traditionally use hidden lines for geometry that is behind other geometry.
<b>Hit Radius</b>	The distance, in pixels, that is detectable by the Drafting Assistant between the object and the pointer.

---

<b>IGES</b>	An acronym for Initial Graphics Exchange Specification. The U.S. Department of Commerce, National Bureau of Standards issues IGES, which is intended to be the industry standard among CAD/CAM systems for data exchange in a neutral file format. Ashlar-Vellum Graphite supports IGES Version 4.0.
<b>Import</b>	To load a non-Graphite file.
<b>Inscribed</b>	Within a circle. For polygons, all vertices touch the (imaginary) circle.
<b>Intersection</b>	The position where two lines or curves meet. The curves may actually touch or only intersect when they are extended.
<b>Isometric</b>	A top, front and right view in which the X-axis is at $-30^\circ$ from the screen horizontal, the Y-axis is $30^\circ$ from the screen horizontal and the Z-axis is vertical.
<b>Knot Points</b>	The points defining a spline, indicated as <b>vertex</b> points by the Drafting Assistant.
<b>Layer</b>	Analogous to transparent media used in conventional manual drafting. Parts can be constructed on several layers which can be made visible or invisible.
<b>Line Tool</b>	The tool that draws single, connected, parallel lines, or smart walls.
<b>Linear Duplicate</b>	The command that copies an object in a line or in an array of multiple lines.
<b>Lock</b>	The command to render a selection unchangeable.
<b>Mask</b>	To select entities as a group, masking out all others.
<b>Math Operator</b>	The mathematical, trigonometric, or exponential expression used to indicate values. All value entry boxes in Graphite accept the math operators listed in Appendix A.

<b>Message Line</b>	The top line of the drawing area. It names the current tool and provides instructions for using it.
<b>META</b>	The file format used by the Windows Clipboard.
<b>Mnemonics</b>	The key sequence which invokes a command from a menu.
<b>Model</b>	The geometry that is incorporated into a view. The model is the geometry that a view sees.
<b>Non-planar</b>	Surfaces or points that do not lie in a two dimensional plane.
<b>NURB</b>	<p>Non-Uniform Rational B-splines—the type of splines Graphite creates. NURB splines are a superset of Bezier curves. NURB splines provide designers with two interrelated functions.</p> <p>First, curvature continuity remains intact even when the curve is changed, so kinks won't develop as the spline is altered. Second, localized control of a complex curve is provided, so an area can be isolated for changes without affecting the remainder of the spline.</p>
<b>Object</b>	An individual piece of geometry, such as a line, arc, or circle.
<b>Object Rotation</b>	The command that rotates geometry around any axis.
<b>Origin</b>	The 0,0,0 location on the drawing area. When a new document is opened, 0,0,0 is located in the middle of the screen. The coordinate symbol displays at the origin when the grid is turned on. The origin can be changed at any time.
<b>Orthogonal</b>	A 2D view of a 3D model which does not show perspective, usually the top, front and right view of the model.
<b>Palette</b>	A group of tools. The general tool palette is always displayed to the left of the drawing area.

---

<b>Parametrics</b>	Integrated parametrics is available through the <i>Resolve</i> and <i>Symbol</i> commands. Once geometry is created, add dimensions as variables or real values. Choose <i>Resolve</i> , to enter specific dimensions for the variables, and the object is drawn to the specifications.
<b>Part</b>	A solid with or without associative history.
<b>Paste</b>	To place the contents of the Clipboard in the current document.
<b>Perpendicular</b>	At a 90° angle.
<b>PICT</b>	The Macintosh graphics file format which uses object-oriented bitmaps or resolution-independent graphics.
<b>Pick</b>	To select a location or object by clicking it.
<b>Planar</b>	Surfaces or points that lie in one two-dimensional plane.
<b>Plot</b>	To print on paper using a plotter.
<b>Plotter</b>	A vector drawing device for hardcopy output.
<b>Point</b>	A location for constructing geometry.
<b>Pointer</b>	The position locator similar to a cursor. When a tool is in effect, the pointer takes on a representative shape while in the drawing area.
<b>Polar Duplicate</b>	To copy a selection and rotate it around a reference point.
<b>Polygon Tool</b>	The tool that draws regular polygons, that is, objects with equal sides. Specify rectangles and inscribed or circumscribed polygons.
<b>Press</b>	To press and hold down the mouse button. This action is most commonly used to view the contents of a menu.
<b>Redo</b>	The command that reverses the action of the <b>Undo</b> command.
<b>Redraw</b>	To refresh the screen, recreating all objects.

<b>Relative Position</b>	A location specified as a certain distance from another location. It is often called the delta position.
<b>Relimit</b>	A trim tool that lengthens or shortens lines to the specified object.
<b>Resolve</b>	The command that draws geometry according to the specific indicated measurements. See Parametrics.
<b>Right-hand rule</b>	<ol style="list-style-type: none"><li>1. A memory aid for the relative directions of the positive axes. With your right palm upturned, the thumb (X) points right, the index finger (Y) points straight ahead and the middle finger (Z) points up. If you move your hand to indicate the X and Y axes, you can easily see the direction of the Z axis.</li><li>2. A memory aid in which the thumb of the right hand points in the direction of the positive axis of rotation. The fingers curve in the direction of rotation.</li></ol>
<b>Segment Tool</b>	The tool used to divide a line or curve at specific boundaries.
<b>Selection Tool</b>	The tool that selects objects. Usually, subsequent actions affect only the selection. Also used to move selected geometry.
<b>Sheet</b>	An unbounded region for drawing. Think of a sheet as one page in a set of blueprints.
<b>Slope</b>	The change of <b>x</b> relative to <b>y</b> between two points on a line. In a spline, slope defines the vector of a line tangent to the spline at a particular knot point.
<b>Smart Symbol</b>	A symbol created with the <b>Smart Wall</b> tool which is automatically incorporated into a smart wall.
<b>Smart Wall</b>	A tool to create special double walls automatically, trimming overlapping intersections.
<b>Snap</b>	The <i>Preferences</i> command that sets the specifications for the Drafting Assistant.

---

<b>Snap Command</b>	Activates or deactivates different snap modes of the Drafting Assistant.
<b>Spline</b>	A smooth, free-form curve passing through specified points.
<b>Status Line</b>	The line at the bottom of the drawing area to enter the specifications for the geometry being created.
<b>Stretch Tool</b>	Used to stretch the geometry along one axis and at a specified angle.
<b>Symbol Libraries</b>	Groups of symbols of the same type. These were either included with Graphite or created by you.
<b>Symbol</b>	The command that retrieves a predefined drawing. This command may use Graphite's integrated parametric feature.
<b>Tangent</b>	The point where a line or curve touches a curve without intersecting it. The Drafting Assistant displays the <i>tangent</i> notation of a curve when the pointer nears it.
<b>Textblocks</b>	This command creates a standard text block for multiple use.
<b>Text Tool</b>	The tool for drawing annotation. Specifies a text box (the area where text is displayed) for entering the text.
<b>Text Lines Tool</b>	Used to place text within a geometrically created horizontal line.
<b>Toggle</b>	To switch between two conditions, for example, <i>Hide Grid/Show Grid</i> .
<b>Transformation</b>	The tools to move, rotate, expand or shrink, or mirror an object or group of entities.
<b>Trim</b>	To shorten or remove a portion of a line.
<b>Trimetric</b>	A top, front and right view in which the Z-axis is vertical, the X-axis is at $-30^\circ$ from the screen horizontal and the Y-axis is at $15^\circ$ from the screen horizontal.
<b>Undo</b>	The command that reverses the last editing or creation action.

---

<b>Unfold</b>	To open a model 90° along an axis.
<b>Units</b>	Measures used for display of geometry.
<b>Vertex</b>	The point at which the sides of an angle intersect, or a knot point of a spline.
<b>View-dependent</b>	Geometry that appears only in the view in which it was created. Crosshatching, text, GD&T symbols and dimensions in a detail view are view-dependent.
<b>Visible</b>	A pen style.
<b>Wireframe</b>	A 3-dimensional representation showing boundary lines, edges and intersections, but not surfaces.
<b>World Plane</b>	The work plane used at the beginning of the construction of a model. Also known as the world coordinate system.
<b>Work Plane</b>	The x,y plane used for 2D objects which has an origin of 0,0,0 for all data input. Sometimes referred to as the user or work coordinate system.
<b>Zoom</b>	The tool or command that magnifies or reduces an image.



# Index

## Symbols

% Point 4-8

## Numerics

2D analysis

Command 18-2

Displaying the Centroid 18-5

2D analysis calculation 18-1, 18-5

Area 18-3

Centroid 18-4

Inertia 18-4

Perimeter 18-3

Tolerance 18-2

Weight 18-4

Weight Per Area 18-3

2-Entity

Chamfer 10-4

Fillet 10-2

2-Point Center Ellipse tool 7-24

3-Corner Ellipse tool 7-27

3D

Drawing tools 8-1

Extrude 8-4

Features/tools 8-4

Geometry 8-1

Revolve 8-6

Tracer tool 8-4

Work plane 8-9

3D construction rules 8-3

3D geometry

Arcs 8-3

Circles 8-3

Ellipses 8-3

Fillet 8-4

Lines 8-3

Rectangles 8-3

Splines 8-3

3D viewing 6-8

3-Entity Fillet tool 10-3

3-Point Center Ellipse tool 7-26

3-Point plane command 8-9, 8-13

3-Point tools

Arc 7-18

Circle 7-22

## A

Absolute value A-1

Active view 13-21

Add Spline Control Point tool 7-33

Addition A-1

Align axis

x 2-5

y 2-5

z 2-5

Alignment

Angles 4-7

Drafting Assistant 2-5

GD&T 20-2

Text 11-8

Anchors (parametrics) 16-8

Angles

Alignment 4-7

Construction 4-10, 4-13

Creation 4-8

Angular Chamfer tool 10-4

Angular dimension command 12-34

Angular dimension settings 12-34

Angular Dimension tool 12-27

Angularity, GD&T 20-6

ANSI

Font 11-6

GD&T 20-1, 20-13

Arc Length Dimension tool 12-29

Arc tools 7-17

3D 8-3

3-Point 7-18

Center-Point Arc 7-17

Tangent objects 7-18

Tangent-Point 7-19

Arctangent A-1

Area 18-3, 19-7

Arrange menu 3-12

- Arrow pointer 3-2
- Arrowhead
  - Arrow at end 11-20
  - Arrow at start 11-20
  - Dimension 12-41
- Arrowhead appearance
  - Pen 11-19
  - Size 11-19
  - Type 11-19
- ASCII 15-11, 15-13
- Associative
  - Detail view 13-19, 14-15
  - Dimensions 12-2
- Asterisks 3-17
- Attribute operation
  - Assigning 19-7, 19-9, 19-12
  - Command 19-4
  - Defining 19-3
  - Deleting 19-6
  - Editing 19-6, 19-11
  - Hide 19-7
  - Lock/Unlock 19-6
  - Removing 19-12
  - Save 19-7
  - Show 19-7, 19-11
- Attribute tools
  - Selection 19-9
  - Symbol Attributes 19-10
- Attribute type
  - Predefined 19-2, 19-7
  - User-defined 19-2
  - Vellum attributes 19-7
- Attributes
  - Active 19-4
  - Order 19-20
- Auto Front command 13-25
- Automatic Dimensioning tool 12-9
- AutoSave
  - Command 15-5
  - Preference 5-31

**B**

- Backup 15-5
- Balloon
  - Dimension tool 12-30
  - Item number 19-14
  - Pen style 5-2, 5-19
- Base Line dimension
  - Horizontal 12-11
  - Oblique 12-18
  - Perpendicular 12-21
  - Vertical 12-14
- Bill of Materials 19-1
  - Attributes 19-2, 19-3
  - Introduction 19-2
  - Layout options 19-18
  - Layouts 19-16
  - Palette 19-8
  - User format 19-20
- Bill of Materials operation
  - Creating 19-20
  - Defining layout 19-17
  - Editing 19-21
  - Exporting 19-22
- Bitmap
  - Export 15-17
  - Import 15-12
- Blinking selection 9-3
- BMI
  - Import 15-11
- BOM tools 19-7
  - Attribute Selection 19-9
  - BOM 19-20
  - Item Number 19-13
  - Symbol Attributes 19-10
- Bring to Front command 13-26

**C**

- Calculation, 2D analysis 18-1, 18-5
- Camera
  - Detail view 14-37
  - Sheet view 2-2, 14-37
  - View/Sheet 14-40

- Center pen style 5-2, 5-18
- Center, Drafting Assistant 4-3
- Center-Point tools
  - Arc 7-17
  - Circle 7-20
- Centimeters 5-22, A-3
- Centroid 18-4
  - Attributes 19-7
  - Displaying 18-5
- Chain dimension
  - Horizontal 12-11
  - Oblique 12-19
  - Perpendicular 12-22
  - Vertical 12-15
- Chain object 9-10
- Chamfer tools 10-2
  - 2-Entity 10-4
  - Angular 10-4
- Chamfer, Smart wall 7-15
- Check boxes 3-16
- Circle Center Line Dimension tool 12-29
- Circle tools 7-20
  - 3D 8-3
  - 3-Point 7-22
  - Center-Point 7-20
  - Opposite-Point Circle tool 7-21
  - Tangent-Point 7-22
- Circular runout, GD&T 20-8
- Circumscribed Polygon tool 7-29
- Click 7-3
- Close command 15-6
- Color
  - Define 5-5
  - Dimension 12-38
  - Editing 5-6
  - Layer 13-8
  - Pen 5-4
  - Saving 5-7
- Color palette
  - Customizing 5-7
  - Displaying a color 5-7
  - Removing a color 5-7
- Commands
  - Choosing 1-1
- Concentricity, GD&T 20-7
- Conditional expressions A-1
- Connected Lines tool 7-12
- Construction 4-11
  - Angles 4-10, 4-13
  - Command 4-12
  - Geometry 4-14
  - Offset 4-13
  - Pen style 5-2, 5-19
  - X,Y coordinates 4-13
- Construction line type
  - Dynamic 4-9
  - Permanent 4-11
  - Stroke 4-11
- Construction lines 2-5, 4-9
  - Command 4-12
  - Creating multiple 4-13
  - Creating parallel 4-13
  - Delete 4-15
  - Layer 4-11
  - Using 4-9
- Control point 7-33, 9-2
  - Spline 7-35
- Convert Command 15-24
- Convert command 15-16
- Copy 10-33
  - Detail view 13-23
  - Objects 10-27, 10-33
- Corner Trim tool 10-7
- Cosine of angle A-1
- Counting objects 13-12
- Creation angles 4-8
- Crosshatch 2-7, 11-12
  - Command 11-15
  - Detail view 14-16
  - Edit 11-17
  - Patterns 11-12
- Crosshatch type
  - DIN 11-13, 11-17

- ISO 11-13, 11-16
- Cut
  - Command 10-32
  - Detail view 13-22
- Cylindricity, GD&T 20-6
- D**
- Dash handle 5-15
- Dash pen style 5-2, 5-18
- DAssistant
  - Command 4-5
  - Preference 5-31
- Datum, GD&T 20-10
- Decimals A-4
  - # of places 3-10
  - Status Line 7-6
- Default settings
  - Preferences 5-33
- Define
  - Attributes 19-3
  - BOM layout 19-17
  - Color 5-5
  - Pen pattern 5-13
  - Plane 8-9, 8-14
  - View 14-20
- Delete
  - Attributes 19-6
  - Command 10-34
  - Construction lines 4-15
  - Detail view 13-23
  - Item numbers 19-15
  - Layer 13-10
  - Layer group 13-16
  - Model 14-8
  - Plane 8-17
  - Sheet 14-4
  - View orientation 14-22
- Deselection 9-9
- Detail view 2-2, 13-17, 14-32, 14-39
  - Active 13-21
  - Associative 13-19, 14-15
  - Crosshatching 14-16
  - Delete 13-23
  - Dimensions 14-16
  - Fills 14-16
  - Menu 13-22
  - Non-associative 13-19
  - Scale 13-24
  - Text 14-16
  - Tool 13-19
  - Window 13-22
- Detail view camera 14-15, 14-37
- Detail view operation
  - Copy 13-23
  - Cut 13-22
  - Pan 13-23
  - Rotating area 13-20
  - Zoom 13-24
- Diagrams A-3
- Dialog boxes, using 3-14
- Diameter, GD&T 20-8
- Diametral Arrow Dimension tool
  - In 12-26
  - Out 12-25
- Dimension 15-27
  - Arrowhead 12-41
  - Associative 12-2
  - Circle center line 7-20
  - Detail view 14-16
  - Dual 12-33
  - GD&T 20-4
  - Layer 12-8, 12-40
  - Menu 3-12
  - Move 12-7
  - Objects 12-6
  - Parametrics 12-47, 16-4
  - Tools 12-3
  - Work plane 12-5
- Dimension appearance 12-31
  - Color 12-38
  - Font 12-37
  - Fractions 12-34
  - Pen style 5-2, 5-18
  - Size 12-37

- Style 12-38
- Text 12-36
- Weight 12-39
- Witness lines 12-43
- Dimension setting
  - Angular 12-34
  - Angular tolerance 12-35
  - Limits 12-8
  - Linear 12-32
  - Linear tolerance 12-34
  - Standards 12-44
  - Tolerance 12-8, 12-33
- Dimension tools
  - Angular 12-27
  - Arc Length 12-29
  - Automatic Dimensioning 12-9
  - Balloon 12-30
  - Circle Center Line 12-29
  - Diametral Arrow In 12-26
  - Diametral Arrow Out 12-25
  - Horizontal 12-10
  - Oblique 12-17
  - Perpendicular 12-20
  - Radial Arrow In 12-25
  - Radial Arrow Out 12-24
  - Vertical 12-13
- DIN crosshatching 11-13, 11-17
- Divide command 10-37
- Division A-1
- Document
  - New 15-2
  - Organizing 15-1
  - Windows 13-26
- Drafting
  - Drafting Assistant 2-5, 4-1
  - Full scale 5-25
  - Parametrics 16-9
  - Process 5-26
  - Wireframe 2-1
  - With format 5-28
  - Without format 5-27
- Drafting Assistant 2-5, 4-1
  - % Point 4-8
  - Alignment 2-5
  - Alignment angles 4-7
  - Construction angles 4-10
  - Construction lines 2-5, 4-9
  - Creation angles 4-8
  - DAssistant command 4-6
  - Snap command 4-8
  - Snap point 2-5, 4-2, 4-5
  - Z direction 8-9
- Drafting Assistant notation
  - Center 4-3
  - Endpoint 4-3
  - Intersect 4-3
  - Midpoint 4-3
  - Perpendicular 4-4
  - Quadrant 4-3
  - Tangent 4-4
  - Vertex 4-3
- Drag, using mouse 7-3
- Draw View Boundaries command 13-26
- Drawing
  - Formats 2-7
  - Print 15-41
  - Techniques 7-3
  - Tools 7-1
- Drawing area
  - Graphite 3-4, 3-10
  - Scroll bars 3-11
- Drawing at full scale 2-6
- Drawing size command
  - Page bounds 15-33
  - Preview layout 15-34
  - Printing 15-33
  - Scale 3-16
  - Tiled printing 15-34
  - Using 15-29
- Drawing tools
  - 3D 8-1
  - Arc 7-17
  - Circle 7-20

- Ellipse 7-23
- Line 7-10
- Polygon 7-27
- Spline 7-30
- Dual dimensions 12-33
- Duplicate commands
  - Linear 10-12
  - Polar 10-16
- DWG
  - Import 15-11, 15-17
- DXF
  - Configuration files 15-23
  - Export effects 15-19
  - Import 15-11, 15-13, 15-16
  - Import effects 15-14
- Dynamic construction lines
  - Constructing geometry 4-9
  - Existing geometry 4-10
- E**
- Edit
  - Attributes 19-11
  - Bill of Materials 19-21
  - BOM layout 19-18
  - Color 5-6
  - Crosshatching 11-17
  - Item numbers 19-14
  - Macros 6-6
  - Menu 3-12
  - Objects 10-1, 10-35
  - Pattern 5-16
  - Pen style 5-20
  - Symbol 17-5
  - Text 11-3
  - View 14-25
- Editing commands
  - Copy 10-33
  - Cut 10-32
  - Delete 10-34
  - Paste 10-33
  - Redo 10-34
  - Undo 10-34
- Editing tools
  - Chamfer 10-2
  - Fillet 10-2
  - Transformation 10-2, 10-8
  - Trim 10-2
- Ellipse tools 7-23
  - 2-Point Center 7-24
  - 3-Corner 7-27
  - 3D 8-3
  - 3-Point Center 7-26
  - Opposite-Corner 7-25
- Endpoint 4-3
- Environment settings
  - Advanced 6-1
  - Basic 5-1
- EPS 15-21
  - Export 15-17
  - Export effects 15-20
  - Import 15-11
- Equals A-2
- Erasing geometry 10-34
- Exit command 15-6
- Exponentiation A-1
- Export
  - Bill of Materials 19-22
  - Command 15-16
  - Convert 15-16
  - Tips 15-23
- Export type
  - Bitmap 15-17
  - EPS 15-17
  - IGES 15-17
  - MetaFiles 15-17
  - Pict 15-17
  - Text 15-17
- Extrude
  - Command 8-4
- Eye Dropper G-6
- Eye Dropper Tool 9-8

**F**

Feature control frame 20-5  
    Diameter 20-8  
Feet A-3  
File 15-10  
    Backup 15-5  
    Menu 3-12  
    Organization 15-7  
    Plotting to a file 15-43  
    Program files C-1  
    Program settings C-1  
    Recent file list 15-3  
File command  
    Close 15-6  
    Exit 15-6  
    Export 15-9  
    Import 15-9  
    Open 15-2  
    Save 15-3  
Filename 15-3  
Fill  
    Command 11-19  
    Detail view 14-16  
    Solid 11-12, 11-18  
Fillet  
    3D 8-4  
    Smart wall 7-15  
Fillet tools 10-2  
    2-Entity 10-2  
    Fillet 10-3  
Flatness, GD&T 20-6  
Flatten view 2-7, 14-26  
Font  
    ANSI 11-6  
    Dimension 12-37  
    Plotter 11-11, 15-43  
    Text 11-5  
    Text size 11-7  
Format  
    Creating 15-38  
    Drafting with 5-28

Drafting without 5-27  
Drawing 2-7, 15-35  
Importing 15-36  
Modifying 15-37  
Placing 15-36  
Sheet into view 14-18, 15-37  
Views 14-28

**Forms**

Command 15-39  
Creating 15-39

Fractions, dimensions 12-34

Front view 14-20

**G**

GD&T 20-1

ANSI 20-1, 20-13  
Background 20-2  
Command 20-13  
Dimension 20-4  
Geometric characteristic 20-5  
Label 20-13  
Material condition 20-8  
Symbols 20-11

GD&T setting

Alignment 20-2  
Bonus tolerance 20-3  
Datum 20-10  
Feature control frame 20-5  
Tolerance 20-8, 20-12

Geometric characteristic

Angularity 20-6  
Circular runout 20-8  
Concentricity 20-7  
Cylindricity 20-6  
Flatness 20-6  
Parallelism 20-7  
Perpendicularity 20-7  
Profile of Line 20-6  
Roundness 20-6

- Straightness 20-5
- Symmetry 20-7
- Total runout 20-8
- True position 20-7
- Graphite
  - Constructing a model 2-6
- graphite prefs 3-19
- Graphite Window
  - Drawing area 3-4, 3-10
  - Menu Bar 3-3, 3-12
  - Message Line 3-4, 3-9
  - Pointer 3-3
  - Pointer Locator 3-4
  - Scroll Bars 3-4, 3-11
  - Status Line 3-4, 3-10
  - Title Bar 3-3, 3-4
  - Tool palette 3-3, 3-6
  - Work Layer Indicator 3-4, 3-11
- graphite.ini 5-29
- Grid 5-23
  - Command 5-23
  - Drawing area 3-11
  - Show 3-11, 5-23
- Grid setting
  - Origin 5-23
  - Preferences 5-31
  - Spacing 5-24
  - Subdivision 5-24
- Group
  - Command 9-2, 10-38
  - Parametrics 16-27
- H**
- Hatch 11-17
- Hidden pen style 5-2, 5-18
- Hide
  - Attributes 19-7
  - BOM palette 19-8
  - Layer 13-11
- Hide points 9-12
- Hit radius 4-7
- Horizontal Dimension tools
  - Base Line 12-11
  - Chain 12-11
  - Horizontal 12-10
  - Ordinate 12-12
- Hot spot 3-8
- HPGL 15-43
- I**
- ifelse A-2
- IGES 15-17
  - Export 15-17
  - Export effects 15-20
  - Import 15-11
- Import
  - Command 15-10
  - Formats 15-36
  - Symbol 17-5
  - Text 11-2
- Import type
  - ASCII 15-11, 15-13
  - Bitmap 15-12
  - BMI 15-11
  - DWG 15-11, 15-17
  - DXF 15-11, 15-13, 15-16
  - EPS 15-11
  - IGES 15-11
  - MetaFiles 15-11
  - Pict 15-12
  - Spline 15-11, 15-13
  - Text 15-11, 15-13
- Inches 5-22, A-3
- Indenting text 11-10
- Inertia 18-4
- Inscribed Polygon tool 7-28
- Intersect, Drafting Assistant 4-3
- Invert preference 5-31
- ISO crosshatching 11-13, 11-16
- Isometric view 14-20
- Item number
  - Balloon 19-14
  - Text 19-14
  - Tool 19-13



- Item number operation
  - Assigning 19-13
  - Delete 19-15
  - Editing 19-14
  - Object copies 19-15
  - Renumber 19-15
- K**
- Keyboard
  - Versus mouse 3-13
- L**
- Layer 4-11, 13-7
  - Color 13-8
  - Command 13-9
  - Construction 4-11
  - Dimension 12-8, 12-40
  - Sheet/Models 13-16
  - Smart wall 13-13
  - Work 13-11
- Layer groups
  - Command 13-14
  - Creating 13-15
  - Delete 13-16
  - Renaming 13-16
- Layer operation
  - Counting objects 13-12
  - Creating 13-10
  - Delete 13-10
  - Displaying 13-11
  - Group 13-13
  - Hide 13-11
  - Move objects 10-26, 10-36
  - Renaming 13-10
- Layout
  - Bill of Materials 19-16
  - BOM edit 19-18
  - BOM Layouts command 19-16
  - BOM options 19-18
  - Custom view 14-31
  - Defining BOM layout 19-17
  - Menu 3-12
  - Preview 15-34
- See also Formats
  - Sheet into view 14-18
  - View 14-27
- Leading 0s 5-22
- Limits, dimension 12-8
- Line creation
  - Click 7-4
  - Drag 7-5
- Line tools 7-10
  - 3D 8-3
  - Connected 7-12
  - Parallel 7-14
  - Single 7-10
  - Smart Wall 7-15
- Linear dimension settings 12-32
- Linear duplicate 10-12
- Linear tolerance 12-34
- Location Indicator 3-9
- Lock
  - Command 10-39
  - Splines 7-34
  - Trackball 6-10
- Lock Spline Control Point tool 7-34
- Log (Base 10) A-1
- M**
- Macintosh
  - Fonts 5-30
  - graphite prefs 3-19, 5-30
  - OS settings 5-30
  - Page setup 15-29
  - Recent file list 5-30
- Macros 6-3
  - Command 6-3
  - Creating 6-5
  - Editing 6-6
  - Limitations 6-7
  - Removing 6-6
  - Running 6-7
- Magnifying glass tool 13-3

- Margin notes
  - Referral 1-2
  - Tech note 1-2
  - Tip 1-2
- Material condition, GD&T 20-8
- Math operators A-1
- Megahertz A-3
- Menu
  - Arrange 3-12
  - Dimension 3-12
  - Edit 3-12
  - File 3-12
  - Layout 3-12
  - Modules 3-13
  - Pen 3-12
  - Submenus 3-14
  - Text 3-12, 11-5
  - Trackball view menu 6-10
  - Utilities 3-12
  - Views 3-12
- Menu Bar 3-3
- Menu, using
  - Choosing a command 1-1, 3-13
  - Displaying 3-13
  - Toggling commands 3-18
- Message Line 3-4, 3-9, 7-9
- MetaFiles
  - Export 15-17
  - Import 15-11
- Meters 5-22, A-3
- Midpoint, Drafting Assistant 4-3
- Millimeters 5-22, A-3
- Mirror tool 10-11
- Model 14-5, 14-38
  - 3D construction 2-6
  - Command 14-7
  - Model space 2-2, 14-38
  - Multiple 14-5
  - Sheets 14-7, 14-9
  - Sheets/Views 14-36
- Model operation
  - Creating 14-7
  - Delete 14-8
  - Identifying 14-16
  - Make current 14-8
  - New 14-6
  - Renaming 14-8
- Models 2-2
- Modules menu 3-13
- Moment of inertia 18-4
- Mouse
  - Arrow pointer 3-2
  - Clicking 3-2, 7-3
  - Double-click 3-2
  - Dragging 3-2, 7-3
  - Pointer 3-2
  - Selection arrow 3-2
  - Smart pointer 3-8
  - Using 3-1
  - Versus keyboard 3-13
- Move
  - Dimension 12-7
  - Objects 10-24
  - Objects to layer 10-26, 10-36
  - Text 11-4
- Move tool 10-8
- Multiplication A-1
- N**
- Nanoseconds A-3
- Natural log (Base e) A-1
- Navigator Palette
  - View 13-27
- Negative value A-1
- Nudge Tool 10-9
- NURBS 7-30
- O**
- Objects
  - # on layer 13-12
  - Changing characteristics 10-35
  - Copy 10-27, 10-33
  - Cut 10-32
  - Deselecting 9-9
  - Dimension 12-6

- Edit 10-1, 10-35
- Expand/Shrink 10-10
- Group 10-38
- Lock 10-39
- Mirroring 10-11
- Move 10-8, 10-24
- Relimit 10-6
- Rotating 10-9
- Segment 10-7
- Selecting 9-2, 9-4
- Size 10-29
- Trimming 10-6
- Ungroup 10-38
- Unlock 10-39
- Oblique Dimension tools
  - Base Line 12-18
  - Chain 12-19
  - Oblique 12-17
- Offset
  - Command 10-21
  - Construction lines 4-13
  - Creating point offset geometry 7-9
  - Distance 10-21
- On-Line help (Windows) 1-5
- Open command 15-2
- Operators A-1
  - Absolute value A-1
  - Addition A-1
  - Arctangent A-1
  - Cosine of angle A-1
  - Division A-1
  - Equals A-2
  - Exponentiation A-1
  - ifelse A-2
  - Log (Base 10) A-1
  - Multiplication A-1
  - Natural log (Base e) A-1
  - Negative value A-1
  - Parenthetical A-1
  - Random A-1
  - RNG A-2
  - Round A-1
  - Scientific notation A-1
  - Sine of angle A-1
  - Square root A-1
  - Subtraction A-1
- Opposite-Corner Ellipse tool 7-25
- Ordinate dimension
  - Horizontal 12-12
  - Perpendicular 12-23
  - Vertical 12-16
- Origin 8-7
  - Setting 8-12
  - Work plane 8-12
- OS settings
  - Macintosh 5-30
  - Windows 5-29
- Outline pen style 5-2, 5-18
- P**
- Page setup 15-29
- Palette
  - Bill of Materials 19-8
  - Color 5-7
  - Main palette 3-6
  - Save 5-32, 5-33
- Pan, detail view 13-23
- Parallel construction lines 4-13
- Parallel Lines tool
  - Using 7-14
- Parallelism, GD&T 20-7
- Parametrics 16-1
  - 3D 16-29
  - Anchoring geometry 16-8
  - Complex drafting 16-20
  - Dimension 12-47, 16-4
  - Drafting 16-9
  - Grouped objects 16-27
  - Insertion point of symbols 17-2
  - Problems 16-13
  - Resolve 16-6
  - Rules 16-3

- Symmetry 16-19
- Text file 16-7
- Wave forms A-4
- Parenthetical A-1
- Paste 10-33
- Pattern
  - Crosshatch 11-12
  - Dash handle 5-15
  - Define pen 5-13
  - Edit pen command 5-16
  - Pen 5-11
  - Scale 15-26
  - Standard pen 5-11
  - Undoing pen edit 5-17
  - User-defined pen 5-12
  - Visible pen length 5-13
- Pen
  - Arrowheads 11-19
  - Characteristics 5-3
  - Color 5-4
  - Menu 3-12
  - Pattern 5-11
  - Style 5-18, 5-19
  - Styles 5-1
  - Weight 5-8
- Percentage point, DA 4-8
- Perimeter 18-3, 19-7
- Permanent construction lines 4-11
- Perpendicular Dimension tools
  - Base Line 12-21
  - Chain 12-22
  - Ordinate 12-23
  - Perpendicular 12-20
- Perpendicular lines 7-11
- Perpendicular, Drafting Assistant 4-4
- Perpendicularity, GD&T 20-7
- Phantom pen style 5-2, 5-18
- Pict
  - Export 15-17
  - Import 15-12
- Plane
  - Define 8-9, 8-14
  - Delete 8-17
  - Redefine 8-17
  - Rename 8-16
  - Set to screen 8-18
  - Standard 8-9
  - Temp 8-9
  - View 14-25
  - Work 8-9
- Plot
  - Drawing 15-33
  - Scale 15-30, 15-32
- Plotter fonts 11-11, 15-43
- Point
  - Control 7-33, 9-2
  - Creating 7-11
  - Hide 9-12
  - Selectable point command 9-13
  - Selecting 9-11, 9-12
  - Show 9-11
- Pointer 3-2, 3-3
  - Locator 3-9
  - Smart 3-8, 7-3
- Pointer Locator 3-4, 3-9
- Polar duplicate 10-16
- Polygon tools 7-27
  - Circumscribed 7-29
  - Inscribed 7-28
  - Rectangle 7-28
- PostScript 15-43
- Precision
  - Setting 3-10, 5-21
  - Status Line 7-6
- pref.vlm 5-32
- Preferences 3-19
  - AutoSave 5-31
  - Command 5-30
  - DAssistant 5-31
  - Default 5-33
  - Default setting 3-19
  - Grid 5-31
  - Invert 5-31
  - Save 5-32

- Saving 3-20, 5-30
  - Selection 5-31
  - Snap 5-31
  - Units 5-31
  - Visualization 5-32
  - prefs.vlm 3-19
  - Preview layout 15-34
  - Print 15-33
    - Command 15-42
    - Drawing 15-41
    - Tiled 15-34
  - Print scale 15-30, 15-32
  - Print setup 15-29
  - Printing 15-43
  - Profile of line, GD&T 20-6
- Q**
- Quadrant, Drafting Assistant 4-3
- R**
- Radial Arrow Dimension tool
    - In 12-25
    - Out 12-24
  - Random A-1
  - Recent file list 15-3
    - Macintosh 5-30
    - Windows 5-29
  - Rectangle tool 7-28
    - 3D 8-3
  - Redo 10-34
  - Redraw screen 10-39
  - Referral 1-2
  - Relimit tool 10-6
  - Remove
    - Macros 6-6
  - Resolve
    - Command 16-6
    - Parametrics 16-6
  - Revolve
    - # of steps 8-7
    - Command 8-6
    - Origin 8-7
    - Sweep Angle 8-7
  - Right view 14-20
  - Right-hand rule 6-13
  - RNG A-2
  - Rotate
    - Active view 6-10
    - Sheet view 6-10
    - Text 11-6
  - Rotate tool 10-9
  - Rotate view
    - Geometry axis 6-11
    - Screen axis 6-12
    - X-axis 6-11
    - Y-axis 6-11
    - Z-axis 6-11
  - Round A-1
  - Roundness, GD&T 20-6
  - Rules
    - 3D construction 8-3
    - Parametrics 16-3
    - Right-hand 6-13, 8-7
- S**
- Save
    - Attributes 19-7
    - AutoSave 15-5
    - Color 5-7
    - Palette 5-32, 5-33
    - Preferences 3-20, 5-30, 5-32
    - Save As 15-4
    - Save command 15-4
  - Scale 3-16, 15-27
    - Detail view 13-24
    - Dimensions 15-27
    - Drawing at full scale 15-26
    - Full scale drawing 2-6, 5-25
    - Lines/crosshatches 15-26
    - Paper size 15-28
    - Patterns 15-26
    - Text 11-7, 15-27
    - Views 14-16
  - Scaling views 14-16
  - Scientific notation A-1
  - Screen display scale 14-16

- Scroll Bars 3-4
- Segment tool 10-6
- Selectable Points
  - Command 9-4
- Selection 9-3
  - Arrow 3-2
  - Command 9-3
  - Deselecting 9-9
  - Indicating 9-3
  - Objects 9-2, 9-4
  - of points 9-12
  - Points 9-4, 9-11, 9-12
  - Select All 9-5, 9-9
  - Selectable points 9-13
  - Selecting a tool 3-7
  - Selection Mask 9-5, 9-9
- Selection setting
  - Blinking 9-3
  - Preferences 5-31
- Selection tools
  - Select by Line 9-5
  - Select by Polygon 9-7
  - Selection 9-4
  - Tracer 9-6
- Send to Back command 13-26
- Sheet 2-2, 6-8, 14-1, 14-37
  - Command 14-3
  - Creating 14-4
  - Delete 14-4
  - Making current 14-4
  - Models/Views 14-36
  - Renaming 14-4
  - Sheet into view 2-7
  - Using 14-2
  - View 13-17, 14-39
- Sheet camera
  - Model 2-2, 14-5, 14-37
- Sheet into view 2-7, 5-28, 14-17
  - Erroneous 14-19
  - Format 14-18, 15-37
  - Layouts 14-18
  - Visual scale 15-32
- Sheet view
  - Command 13-17
  - Model 2-2, 14-5
  - Rotate 6-10
- Show
  - Attributes 19-7, 19-11
  - BOM palette 19-8
  - Dimension palette 12-3
  - Grid 5-23
  - Points 9-11
  - Trackball 6-9, 8-2
  - TrackCube 6-9
  - Triad 6-12, 8-2
- Simple Trim tool 10-5
- Sine of angle A-1
- Single Line tool 7-10
  - Perpendicular 7-11
  - Perpendicular lines 7-11
  - Point 7-11
  - Tangent 7-11
- Size
  - Dimension 12-37
  - Objects 10-29
- Slope, splines 7-35
- Smart 17-6
  - Pointer 3-8, 7-3
  - Symbol 17-6
  - Wall 7-15
- Smart wall
  - Layer 13-13
- Smart Wall tool 7-15
  - Architecture 7-15
  - Chamfer 7-15
  - Fillet 7-15
  - Symbols 7-16
- Snap command
  - % Point 4-8
  - Alignment Angles 4-7
  - Basic 4-6
  - Creation angles 4-8
  - Hit radius 4-7
  - Mode 4-8

- Snap point
  - Drafting Assistant 2-5, 4-2, 4-5
  - Preference 5-31
- Solid fill 11-18, 11-19
- Spacing, text 11-9
- Special Characters B-1
- Spell Check 11-4
- Spline
  - Creating a text file 15-14
  - Import 15-11, 15-13
- Spline tools 7-30
  - 3D 8-3
  - Add Spline Control Point 7-33
  - Control point 7-33
  - Lock Spline Control Point 7-34
  - NURBS 7-30
  - Slope 7-35
  - Through-Points 7-31
  - Unlocking 7-34
  - Vector 7-32
  - Vertex 7-32
- Square root A-1
- Standard views 6-13
- Status Line 3-4, 3-10, 7-6
  - Altering geometry 7-7
  - Creating additional geometry 7-8
  - Creating new geometry 7-8
  - Drawing tools 7-7
  - Fields 7-6
  - I-beam 7-6
  - Moving between fields 3-10
  - Precision 7-6
  - Units 5-22
  - Using 7-6
- Straightness, GD&T 20-5
- Stroke construction lines 4-11
- Stroke zoom 13-5
- Style
  - Change 5-3
  - Dimension 12-38
  - Edit pen 5-20
  - Modifying pen 5-19
  - Pen 5-1, 5-18
  - Text 11-8
- Style Conventions, documentation 1-2
- Submenu 1-1, 3-14
- Subtraction A-1
- Sweep angle 8-7
- Symbol 17-1, 17-6
  - BOM Attributes tool 19-10
  - Browse directory 17-5
  - Command 17-3
  - Display symbols in a directory 17-3
  - GD&T 20-11
  - Insertion point 17-2
  - insertion point 17-4
  - orientation 17-4
  - Origin 17-2
  - Parameterized 17-2
  - preview 17-5
  - Smart wall 7-16
  - Symbol Panel 17-3
- Symbol operation
  - Creating 17-2
  - Edit 17-5
  - Import 17-5
  - Insert 17-3
  - Marking object for attributes 19-10
  - Placing 17-3
- Symbol Panel
  - Browse directory 17-4
  - Load new directory 17-5
  - New 17-5
  - Preview pane 17-4
  - Symbol list 17-4
- Symmetry, GD&T 20-7
- T**
- Tangent lines 7-11
- Tangent, Drafting Assistant 4-4
- Tangent-Point tools
  - Arc 7-19
  - Circle 7-22
- Tech note 1-2

- Temp plane 8-9
- Text 11-1, 19-4
  - Box 11-1, 11-3
  - Detail view 14-16
  - Dimension 12-36
  - Item numbers 19-14
  - Menu 3-12, 11-5
  - Scaling 11-7
  - Spell check 11-4
  - Tool 11-2
- Text appearance
  - Alignment 11-8
  - Characteristics 11-3
  - Font 11-5
  - Indenting 11-10
  - Scale 11-7, 15-27
  - Size 11-7
  - Spacing 11-9
  - Style 11-8
- Text operation
  - Editing 11-3
  - Export 15-17
  - Import 11-2, 15-11
  - Moving 11-4
  - Rotate 11-6
  - Spell check 11-4
- Through-Points Spline tool 7-31
- Timing device A-3
- Tip 1-2
- Title Bar 3-3, 3-4
  - Close 3-5
  - Control menu 3-4
  - Macintosh OS 3-5
  - Maximize/Restore 3-5
  - Minimize 3-4
  - Windows OS 3-4
  - Zoom 3-5
- Title blocks 15-39
- Toggling commands 3-18
- Tolerance 12-7
  - 2D analysis 18-2
  - Dimension 12-8, 12-33
  - GD&T 20-3, 20-8, 20-12
- Tool palette 3-3, 3-6
  - Selecting a tool 3-7
- Tools
  - 3D drawing 8-1
  - BOM 19-7
  - Drawing 7-1, 7-10
  - Editing 10-2
  - Selection 9-4
  - Text 11-2
- Top view 2-2, 14-20
- Total runout, GD&T 20-8
- Tracer tool
  - 2D analysis 18-2
  - 3D 8-4
  - Using 9-6
- Trackball 2-3, 2-4, 2-6
  - Hide 6-9
  - Lock 6-10
  - Show 6-9, 8-2
  - TrackCube 6-9
  - View menu 6-10
- Trailing 0s 5-22
- Transformation tools 10-2
  - Mirror 10-11
  - Move 10-8
  - Rotate 10-9
- Triad 2-6
  - Hide 6-12
  - Show 6-12, 8-2
- Trim tools 10-2
  - Corner 10-7
  - Relimit 10-6
  - Segment 10-6
  - Simple 10-5
- Trimetric view 2-4, 14-20
- True position, GD&T 20-7



**U**

Undo 10-34

Unfold view 14-23

Ungroup

Command 7-15, 10-38

Unit type

Centimeters A-3

Feet A-3

Inches A-3

Meters A-3

Millimeters A-3

Units 3-10, 5-22, A-1

Command 5-21

Decimal places 3-10

Leading 0s 5-22

Precision 3-10, 5-21

Preferences 5-31

Status Line 5-22

Trailing 0s 5-22

Unlock

Command 10-39

Splines 7-34

User coordinate system 8-14

Utilities menu 3-12

**V**

Vector Spline tool 7-32

Vertex 7-32, 7-34

Vertex, Drafting Assistant 4-3

Vertical Dimension tools

Base Line 12-14

Chain 12-15

Ordinate 12-16

Vertical 12-13

View 14-15, 14-39

3D 6-8

Active 13-21

Cameras 14-40

Detail 2-2, 13-17, 14-32, 14-39

Displays 13-17

Document windows 13-26

Formats 14-28

Layouts 14-27

Menu 13-25

navigator palette 13-27

Orientation 14-19

Sheet 2-2, 13-17

Sheets/Models 14-36

Trackball 2-3

View the plane 14-25

Window 2-2, 13-22

Zoom commands 14-16

View control tools 13-3

View operation

Creating custom layouts 14-31

Define 14-20

Edit 14-25

Flatten 2-7, 14-26

Rotate 6-10

Scaling 14-16

Unfold 14-23

View orientation

Delete orientation 14-22

Front 14-20

Isometric 14-20

New 14-21

Redefining 14-22

Renaming 14-23

Right 14-20

Setting to screen 14-24

Standard 6-13

Top 14-20

Top view 2-2

Trimetric 2-4, 14-20

Viewing geometry 13-1

Views

Menu 3-12

Views Menu 13-25

Views pop-up menu 6-10

Visible

Pen length 5-13

Pen style 5-2, 5-18

Visualization 6-13

Preference 5-32

## W

- Wall
  - Parametrics 7-16
  - Smart 7-15
  - Symbols 7-16
- Wave forms A-3
- Weight
  - 2D analysis 18-4
  - Attributes 19-7
  - Dimension 12-39
  - Edit command 5-8
  - Pen 5-8
  - Undoing pen edit 5-10
- Window, view 13-22
- Windows
  - graphite.ini 5-29
  - MaxFont 5-29
  - On-Line help 1-5
  - OS settings 5-29
  - prefs.vlm 3-19, 5-30
  - Print setup 15-29
  - Recent file list 5-29
  - Screen 5-29
- Wireframe model 2-1
- Witness lines 12-43
- Work layer 13-11
  - Indicator 3-4, 3-11, 13-11
- Work Plane 8-9
- Work plane 8-9
  - 3-Point plane 8-13
  - Define 8-14
  - Dimensions 12-5
  - Origin 8-12
  - Set to screen 8-18
  - Setting 8-10, 8-13
  - Specifying position 8-11
- World coordinate system 8-14

## Z

- Zoom
  - All 13-2
  - Commands 13-2
  - Detail view 13-24
  - In 13-2, 13-3
  - Out 13-2, 13-4
  - Previous 13-2
  - Stroke 13-5







